



True *Light*
Experiences.

2019 | 22

True Light Experiences.





KREATIVE PRODUKTVIELFALT VON MK ILLUMINATION

*Licht erhellt nicht nur Räume,
Licht schafft Stimmung.*

Festlich erleuchtete Orte fühlen sich einfach besser an. Sie schaffen Optimismus, hinterlassen Eindruck. Egal, ob Sie sich eine opulente Lichtinszenierung wünschen, ein interaktives animiertes Lichtspiel, klassisch weihnachtlichen Kerzenschein, ein Lichtmotiv als strahlenden Blickfang oder doch eher eine edel reduzierte Festbeleuchtung: Unser Angebot ist so vielfältig, dass wir Ihnen entsprechend Ihren gestalterischen Bedürfnissen garantiert das passende Licht-Produkt liefern können.



Swarovski Crystal Worlds, Wattens – Austria

Unser Sortiment hat sich in den letzten Jahren laufend erweitert, weshalb wir fanden, dass es an der Zeit ist, dieses neu zu strukturieren und zu ordnen. Damit Sie sich in Zukunft noch einfacher zurechtfinden, haben wir unsere Produkte entsprechend deren optischer Wahrnehmung sortiert. Auf den nächsten Seiten stellen wir Ihnen unsere neu arrangierte Produktwelt gerne vor.

Unsere internationalen Design-Teams haben außerdem wieder spannende Neuheiten für Sie entwickelt, die höchste Gestaltungsansprüche

mit technischem und konzeptionellem Know-How gleichermaßen vereinen.

Neben einer kompetenten Produktberatung steht Ihnen unser lokales Team auch gerne in der Planung von ganzheitlichen Licht-Projekten hilfreich zur Seite. Kontaktieren Sie uns, oder werfen Sie einfach einen Blick auf unsere Website, um mehr über unsere Services zu erfahren.

**Wir wollen Menschen glücklich machen,
wo immer wir ihnen begegnen!**

ÜBERSICHT

MK ILLUMINATION PRODUCTS

In unserer neuen „Lighting-Kategorie“, welche im Wesentlichen unser Basissortiment an Lichterketten umfasst, werden Sie viele bewährte „Licht-Klassiker“ unseres Sortiments wiederfinden, ebenso wie einige Neuheiten.

Was genau sich hinter den neuen Lighting-Produktgruppen „Sparkling“, „Animated“, „Pure“ und „Candle Light“ verbirgt, verrät eigentlich schon ihr Name, denn wir haben unsere Basis-Produkte entsprechend ihres optischen Erscheinungsbildes sortiert.

Mit jedem Lighting-Produkt von MK Illumination dürfen Sie ein Qualitätsversprechen verbinden. Denn wir stellen höchste Ansprüche an das Design, die Materialien, die Verarbeitung und die Montagefreundlichkeit unserer Lichterketten. Als führender Hersteller im Premiumsegment stehen wir für ein Höchstmaß an Verlässlichkeit und Wertigkeit – besonders hinsichtlich Legalität, Sicherheit, Effizienz und Nachhaltigkeit, BUY SMART eben. Alle Outdoor-Lichterketten verfügen außerdem über die IP67 Schutzart.

Unser Ziel ist es, unseren KundInnen das gute Gefühl zu geben, die richtige Entscheidung getroffen zu haben – und somit Menschen zu erfreuen.

LIGHTING

Sparkling Light

Pure Light

Animated Light

Candle Light



LIGHTING DESIGN

Light Greenery
Light Motifs
Light Compositions
Light Sculptures

In der Gestaltung unserer Designs führt das Licht Regie.

Eine kreative Grenzenlosigkeit und eine ausdrucksvolle Formensprache machen Licht-Designs von MK Illumination zu einem individuellen Stilerlebnis. Unsere Designteams – weltweit verortet in London, Stockholm, Istanbul, New York, Korea und Innsbruck – setzen auf den ständigen Kontrast zwischen Tradition & Moderne, Naturzitat & Avantgarde, Handwerkskunst & Technik. Aktuelle Interieur-Strömungen und inspirierende Kooperationen mit externen Partnern treiben uns stets an, unserem eigenen Stil noch weitere Glanzlichter aufzusetzen.

Die Verwirklichung unserer Ideen gelingt in unseren Manufakturen in Europa, Asien, Südafrika und Amerika. Exquisite Handwerkskunst, verbunden mit technischen Skills, lässt aus kreativen Ideen wahre Meisterstücke entstehen, ganz egal ob es sich dabei um unsere individuell kreierten Light Sculptures, Light Compositions in Form festlicher Laternenmotive, den charmanten Stern aus unserer Light Motiv Serie oder die naturähnlichen Light Greenery Motive handelt.

Wir erhellen mit unseren Designs keine Räume, sondern schaffen Stimmungen.
Wir gestalten Licht.



LIGHT ACCESSORIES

Schmückende dekorative Elemente untermauern das festliche Bild unserer Lichtinszenierung. Fröhliche Szenarien und lustige Charaktere aus Fiberglas sind besonders bei den kleinen Besuchern äußerst beliebt.





A-ROSA Kitzbühel – Austria

Sparkling Light

Festlich. Dekorativ. Einladend.

Unsere „Sparkling“ Produktreihe umfasst jene Lichterketten, die in ihrer Wirkung – wie der Name „Sparkling“ bereits verspricht – einen besonderen festlichen Glanz erzeugen. Die dieser Gruppe zugeordneten String Lites®, Drape Lites® oder Ice Lites® sind mittlerweile beliebte und bewährte Klassiker des Sortiments. Erhältlich in warm- oder brilliantweiß und weiteren Farben, eignen sie sich besonders gut für Fassaden- und Konturenbeleuchtung. Sie überzeugen durch einzigartige Vielfalt, höchste Qualität und können durch das QuickFix™ System auf einfache Art und Weise individuell erweitert werden. Alle Outdoor Lichterketten verfügen über die IP67 Schutzart.



Pure Light

Designorientiert. Klar. Edel.

Für all jene, die sich einen etwas reduzierteren Lichterglanz wünschen, haben wir unter der Produktkategorie „Pure Light“ ebenfalls die richtigen Produkte in unserem Portfolio: So hat beispielsweise der Kronux Lichtstrang die Anmutung einer geometrischen Form – als Lichteffect an der Fassade wirkt er jedoch fast spielerisch. Die Wirkung unseres „puren“ Lichteffectes reicht je nach Anordnung von homogen bis hin zu skulptural.

Zürich – Switzerland

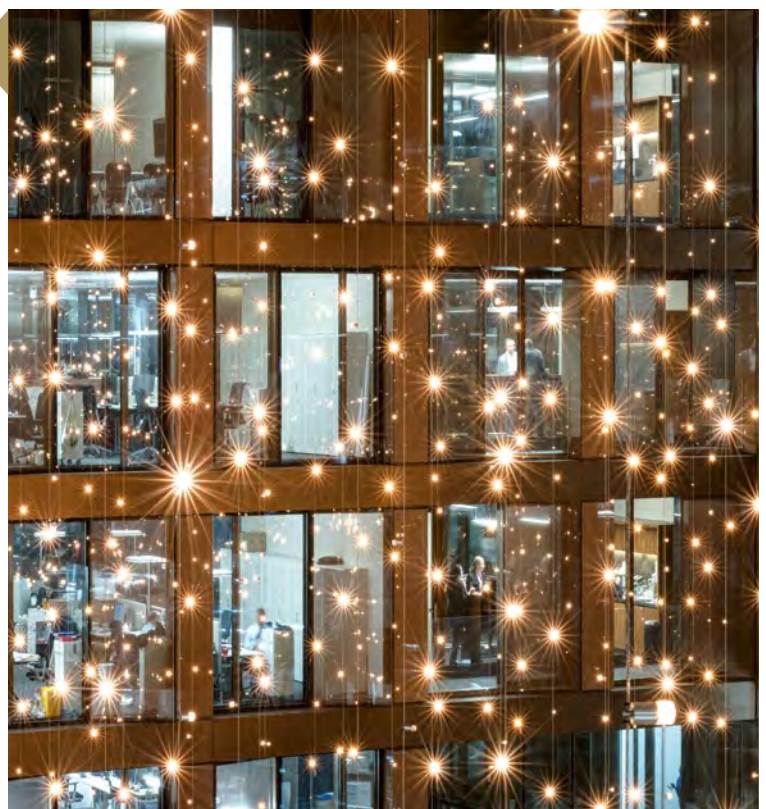

MK ILLUMINATION
PRODUCTS

LIGHTING



Stuttgart – Germany

Animated Light

Funkelnd. Lebendig. Freudvoll.

Unsere animierten Lichtprodukte hauchen Lichterwelten Leben ein und sorgen für ein festlich funkelndes Ambiente. Eine Vielzahl an farbenfrohen Lichtpunkten, individuellen Animationen und lebendigen Effekten verwandeln jeden Ort, ob groß oder klein, in ein unverwechselbares Lichtelebnis. Die Ansteuerung der Lichtpunkte (Pixel), oder die Art des Farbenspiels, kann ganz nach Ihren individuellen Wünschen von unseren MK Technik-Experten programmiert werden.

Candle Light

Klassisch. Traditionell. Festlich.

Unsere Traditionslichterketten, in der Branche vormals bekannt als Röt Pfeil® Produkte, sind altbewährte Klassiker für festliche Dekorationen. Sie sorgen für eine stimmungsvolle und heimelige Atmosphäre im Innen- und Außenbereich. Je nach Anforderung sind die Traditionslichterketten in Flammen- oder Lampenform, mit warmweißem Licht und mit mattem oder geriffeltem Leuchtkörper erhältlich. Flexibel können die Toplampen, die Schafllampen, die Dichtungen oder sonstiges Zubehör getauscht werden.



Private Home

MK ILLUMINATION
PRODUCTS

LIGHTING DESIGN

Lighting Motifs

Unsere beliebten Standard-Lichtmotive lassen sich ganz individuell und flexibel miteinander kombinieren. Sie eignen sich besonders gut für festliche Inszenierungen von Bäumen, Fassaden und ganzen Gebäuden. Ihre Montage ist durch unser MK eigenes QuickFix™ System – das alle Produkte leicht miteinander koppelbar macht – besonders einfach zu bewerkstelligen.



Kitzbühel – Austria



Brookfield Place – Canada

Light Greenery

Die Light Greenery Familie beinhaltet naturgetreue Grünbäume, Grüngirlanden und Kränze mit der dazugehörigen Dekoration sowie unsere klassischen weihnachtlichen Elemente. Die Produkte können auf unterschiedliche Art und Weise geschmückt werden, von der Lichtbestückung bis hin zu winterlich weißer Beflockung und individuell konzeptionierter Dekoration. Innovative Folienschnitte und Stanzformen lassen außerdem farbliche und optische Gestaltungsmöglichkeiten von Bäumen, Girlanden und Kränzen zu.

Light Sculptures

Mit Liebe zum Detail und in feinsten Handwerkskunst entstehen in unserer hauseigenen Manufaktur wahre Schmuckstücke von höchstem Designanspruch. Leuchtende dreidimensionale Unikate, die ihrem Betrachter echte Glücksmomente bereiten.



Koper – Slovenia



Karlsruhe – Germany

Light Compositions

Unsere beliebten zweidimensionalen Lichtmotive für Straßenüberspannungen, Laternen oder Hausfassaden mit entsprechender LED-Technologie, lassen sich wunderbar miteinander kombinieren und ergeben somit ein ausgesprochen festliches Gesamtbild.

MK ILLUMINATION QUALITY

am sicheren QuickFix™+ Verbinder

Darauf finden Sie das MK Illumination Logo, die Musterschutz- und Verifizierungsnummer und die farblich unterschiedlichen Dichtringe – je nach QuickFix™ System. Die QuickFix™+ Stecker verfügen über einen Musterschutz, erfüllen die Schutzart IP67 und sind verpolungssicher ausgeführt. Das Silberlabel ist mit allen relevanten Daten und Warnhinweisen versehen und beinhaltet verschlüsselte Daten wie zum Beispiel das Herstellungsdatum und den Qualitätsprüfungsnachweis.



QuickFix™ 3+



QuickFix™ Outdoor+



QuickFix™ Low Voltage+

an der Kennzeichnung des Kabels

Das „MK Illumination Printing“ am Kabel dient als Qualitätskennzeichnung und Unterscheidungsmerkmal. Die Zertifizierung dieser Kabel nimmt ausschließlich das Deutsche Institut VDE vor.

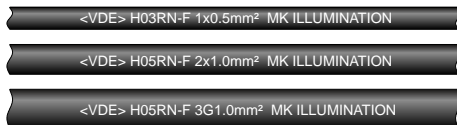

MK Illumination Aufdruck

am Musterschutz

Wir haben eine Vielzahl unserer Designs zum Musterschutz registrieren lassen. Deshalb berücksichtigen und respektieren wir auch andere.

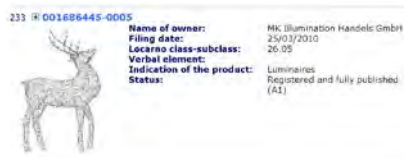

Musterschutz

Sie erkennen
ein original
MK Illumination
Produkt:

an der umweltfreundlichen Verpackung

Wir drucken auf nicht gebleichtem Papier und verzichten auf umweltschädliche Farben. Jede Verpackung wird mit dem Original Quality Seal (Siegel) versehen. Wir achten überdies darauf, dass jedes MK Produkt seine optimale Verpackungsgröße bekommt. Das reduziert den Raumbedarf, optimiert dadurch die Transportwege und spart unnötige CO₂-Emissionen.



MK Illumination Verpackung mit Quality Seal

an der Kennzeichnung der Alukonstruktion

Unsere Light Compositions und Light Sculptures kommen aus unseren zertifizierten Produktionen und die Alukonstruktion ist eigens CE gekennzeichnet.

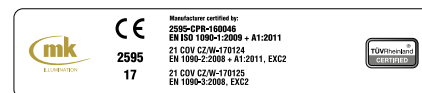

IP67 SYSTEM

Das erste IP67 zertifizierte Profi Lichterketten System am Markt – entwickelt und lanciert von MK Illumination.



NEUES STECKSYSTEM QuickFix™ + Serie



FARBCODIERUNG
die neuen Stecker haben Farbcodes und können somit noch leichter innerhalb der QuickFix™ Systems erkannt werden.

KOMPATIBILITÄT
mit allen QuickFix™ Steckern – auch aus dem alten System – mit Hilfe eines Adapters.

MUSTERSCHUTZ & ZERTIFIZIERUNG

IP67 SCHUTZART

definiert zum einen, dass das Gerät staubdicht ist, zum anderen den Schutz vor zeitweiligem Untertauchen bis maximal 1 Meter Wassertiefe für maximal 30 Minuten.

DOPPELTES DICHRING-SYSTEM

der Standard-Dichtring wird ergänzt mit einem Lamellen-Dichtring.



BUY SMART – mehr Sicherheit und Qualität bei dekorativer Beleuchtung

BUY SMART von MK Illumination ist das erste Bewertungsmodell für dekorative Beleuchtungsprodukte und -motive. Dieses Modell hilft Ihnen, wesentliche qualitative Aspekte beim Kauf von Beleuchtungsprodukten zu überprüfen und zu bewerten.

Es basiert auf vier Stufen: Sicherheit, Legalität, Effizienz sowie Nachhaltigkeit.

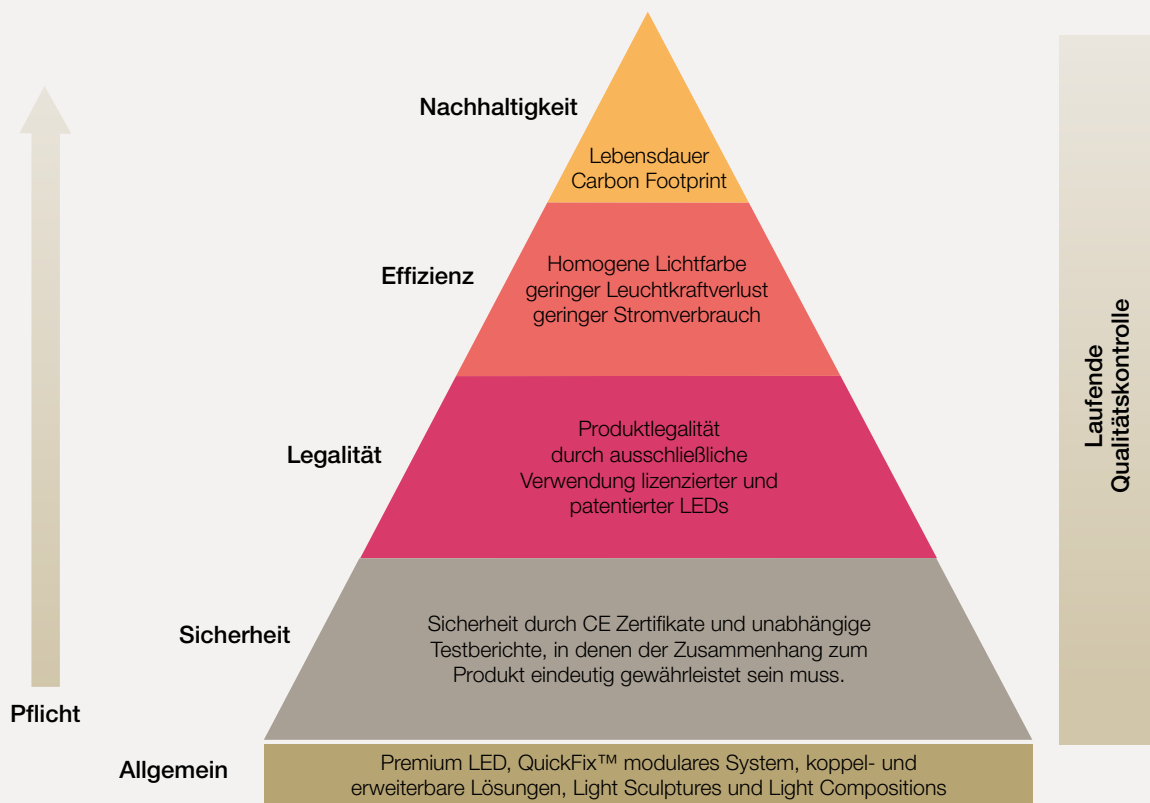

© Buy Smart Valuation Model – MK Illumination

MK Illumination bietet Ihnen Lichtprodukte und -motive, die absolut sicher und legal, effizient sowie der Philosophie der Nachhaltigkeit entsprechen – eben nach den BUY SMART-Kriterien. Das können Ihnen nicht nur das hausinterne Qualitätslabor bestätigen, sondern auch externe, zertifizierte Prüfstellen.

Die durchgängige Qualitätskontrolle beginnt mit den zugelieferten Komponenten und wird laufend in die verschiedenen Produktionsschritte bis hin zur Endkontrolle integriert.

Die Lichtquelle für Ihren Erfolg: die Premium LED

- **PREMIUM LEDs leben länger und sind dadurch effizienter:** Die Premium LED in MK-Qualität zeichnet sich bewiesenermaßen durch eine längere Lebensdauer aus. Und nicht nur das: Tests belegen, dass MK LEDs gegenüber herkömmlichen LEDs kaum an Leuchtkraft (Lumen in Prozent) verlieren. (siehe Grafik)

- **Premium Eco LED:** Die zweite Generation der Premium LED verbraucht nur die halbe Leistung bei gleicher Helligkeit.

- Eine **homogene Lichtfarbe** bei allen Produkten erreichen wir durch die einheitliche Verwendung identer Premium LEDs.

Dabei kommen unsere warmweißen Premium LEDs dem gleichmäßig warmen Lichtschein einer konventionellen Glühbirne beeindruckend nahe. Sie kommen besonders dann gerne zum Einsatz, wenn man eine angenehme wohlige Weihnachtsatmosphäre erzeugen möchte.

warmweiß 2400-2700 Kelvin

Mit unseren ebenfalls homogen leuchtenden brillantweißen Premium LEDs lassen sich aufregende Winterlandschaften und Märchenwelten zaubern.

Die Lichtpunkte erinnern an viele glitzernde Schneekristalle.
brillantweiß 7000-9000 Kelvin

- **Geringer Stromverbrauch.** Unsere Low-Power Premium LEDs verbrauchen bis zu 80 Prozent weniger Energie und zweitens geben kaum Wärme ab.

- **360 Grad Lichtstreuung:** Die MK Premium LED ist in eine Polycarbonat-Kappe mittels Epoxidharz eingegossen und versiegelt. Diese spezielle Kleber-Mischung wirkt wie eine Lupe, unterstützt die Farbstreuung und verstärkt die Ausstrahlungswirkung. Eine sanfte und optimale rundum Lichtstrahlung ist damit garantiert.

- Eine längere Polycarbonatkappe ermöglicht eine höhere Zugfestigkeit der Kabel und ist somit noch belastbarer.

- **Getestet und geprüft:** Alle MK-Produkte wurden und werden auch zukünftig kontinuierlich von anerkannten europäischen zertifizierten Prüfinstituten getestet. SLG, SGS, NEMKO, INTERTEK, VDE. Dadurch gewährt MK die Produktkonformität, Produktsicherheit und geprüfte Produktbauformen.

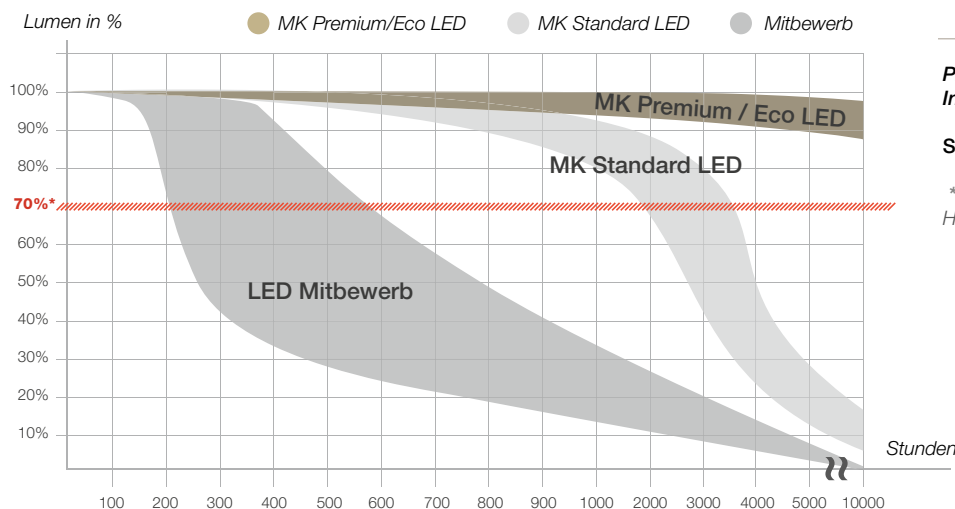

Premium/Eco LED: QuickFix™ Outdoor+, Indoor & Low Voltage+, Strip Lite

Standard LED = Rope Light, LED Bulbs

**70% = erheblich sichtbarer Helligkeitsverlust*

Quelle: Ergebnis aus internen und externen Prüfungen.

Hinsichtlich geltender Standards, gesetzlicher Regelungen und Sicherheitsbestimmungen halten wir Sie gerne auf dem Laufenden: info@mk-illumination.com

QuickFix™
SYSTEM



QuickFix™
OUTDOOR+



Mit jedem Lighting-
Produkt von
MK Illumination
dürfen Sie ein
Qualitätsversprechen
verbinden.

Robust, wetterbeständig
und montagefreundlich.

QuickFix™ Outdoor 230V Gummilichterketten
eignen sich wunderbar für das Schmücken von
Bäumen, Fassaden oder ganzen Gebäuden.
Sie werden nach Schutzart IP67 gebaut und
sind ausschließlich untereinander koppel- und
erweiterbar.

Das Epoxydharz, mit dem die LEDs in die
Polycarbonatkappen eingegossen und versiegelt
sind, garantiert einen sicheren Kontakt und
optimalen Schutz vor Feuchtigkeit.

- // kein Power Supply notwendig
- // koppel- und erweiterbar
- // Segmente austauschbar
- // Schutzart IP67
- // **ohne Netzstecker**
- // inklusive Endkappe

Schutzart
IP67





QuickFix™ INDOOR



Elegant und transparent – die sichersten Indoor-Lichterketten am Markt.

Alle QuickFix™ Indoor 230V PVC Lichterketten sind ausschließlich untereinander koppel- sowie erweiterbar. Diese Produkte sind MKs Highlights auf Christbäumen, Girlanden und Kränzen. Das Epoxydharz, mit dem die LEDs in die Polycarbonatkappen eingegossen und versiegelt sind, schafft einen dauerhaften, sicheren Kontakt.

- // kein Power Supply notwendig
- // koppel- und erweiterbar
- // transparentes Kabel
- // Segmente austauschbar
- // Schutzart IP20
- // **ohne Netzstecker**
- // inklusive Endkappe

Schutzart
IP20

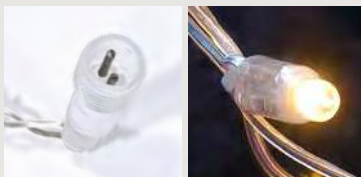

QuickFix™ LOW VOLTAGE+



Für innen und außen – die professionellste Niedervolt Lichterkette am Markt.

Mit dem MK Low Voltage+ System können im Vergleich zu anderen Niedervoltssystemen, Systemlängen bis zu 80 Meter realisiert werden. Das Epoxydharz, mit dem die LEDs in die Polycarbonatkappen eingegossen und versiegelt sind, garantiert einen sicheren Kontakt und gibt Schutz vor Feuchtigkeit. Die montagefreundlichen QuickFix™ Low Voltage+ 36V Lichterketten sind ausschließlich untereinander koppel- sowie erweiterbar. Durch die Schutzkleinspannung (SELV) eignen sie sich besonders gut für Dekorationen im Handbereich sowie wenn Niedervolt vorgeschrieben wird.

- // **Power Supply erforderlich**
- // koppel- und erweiterbar
- // schwarzes Gummikabel
- // transparentes und grünes PVC Kabel
- // Segmente austauschbar
- // Schutzart IP67
- // inklusive Endkappe

Schutzart
IP67



MK ILLUMINATION
PRODUCTS

SPARKLING LIGHT



Schultheiss Quartier, Berlin – Germany



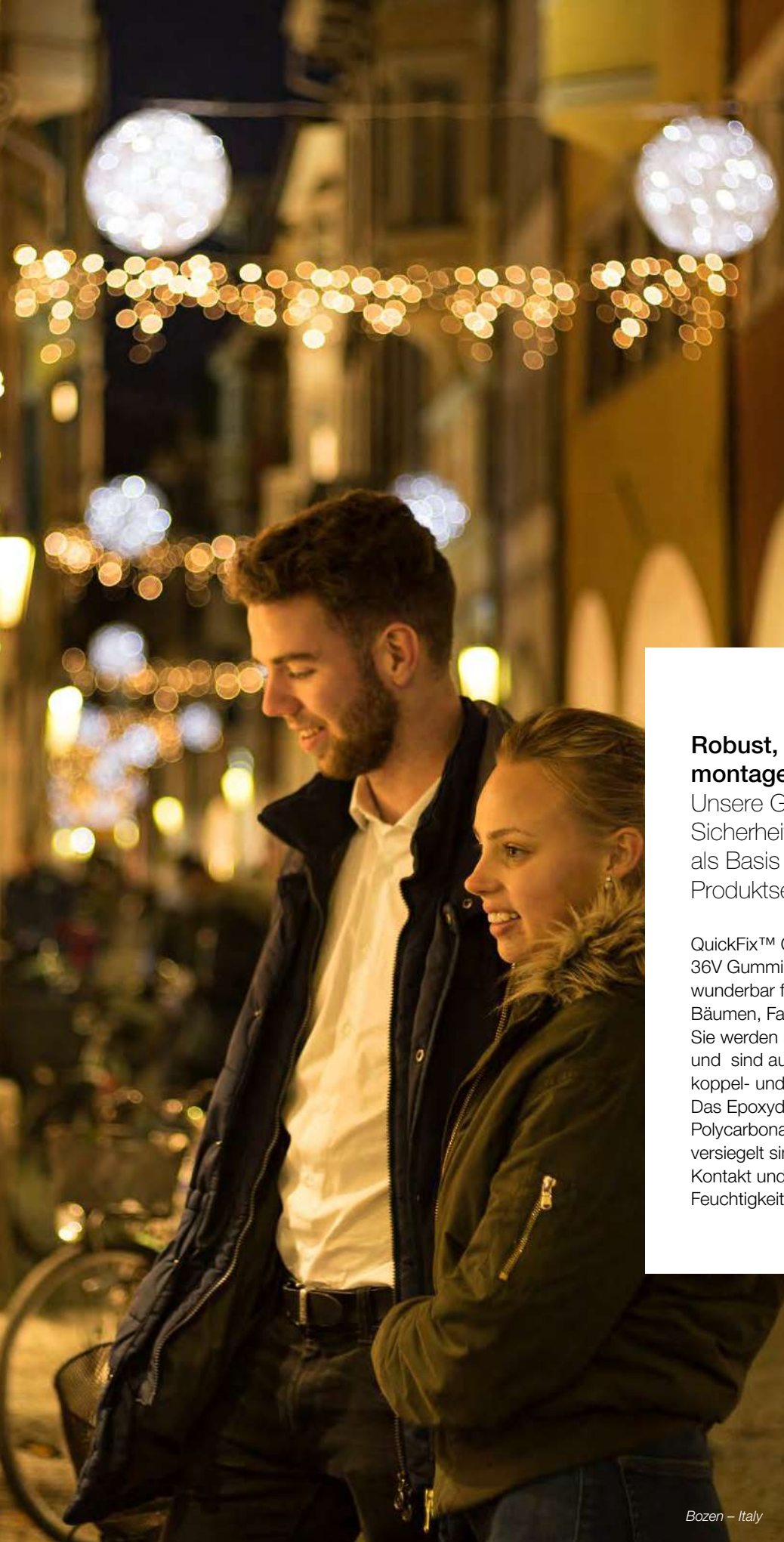

Robust, wetterbeständig und montagefreundlich.

Unsere Gummi-Lichterketten mit Sicherheitsdrehverschluss dienen als Basis der Sparkling Light Produktserie.

QuickFix™ Outdoor 230V / Low Voltage+ 36V Gummilichterketten eignen sich wunderbar für das Schmücken von Bäumen, Fassaden oder ganzen Gebäuden. Sie werden nach Schutzart IP67 gebaut und sind ausschließlich untereinander koppel- und erweiterbar.

Das Epoxydharz, mit dem die LEDs in die Polycarbonatkappen eingegossen und versiegelt sind, garantiert einen sicheren Kontakt und optimalen Schutz vor Feuchtigkeit.



SPARKLING LIGHT

Fremantle – Australia

Die zweite Generation der Premium LED verbraucht nur die halbe Leistung bei gleicher Helligkeit.

Premium Eco[®]

LED: 120
Segmente austauschbar
Ohne Netzstecker

// verbesserte Farbwiedergabe (High CRI > 85%)

// verbesserte optische Wirkung

// geringer Farbunterschied zur Premium LED



QuickFix™ Outdoor+
Rubber 230 V | 3.5 W

1 LED Magic String Lite® 120

019-001



Länge: 2.5 m
Anzahl der Segmente: 1
Lampen pro Segment: 120
Länge pro Segment: 2.50 m
1 Kette = 1 Segment á 2.5 m



// kein Power Supply notwendig
// max. 66 Ketten koppelbar



QuickFix™ Outdoor+
Rubber 230 V | 3.5 W

2 LED String Lite® 120 – 12 m

019-002



Länge: 12 m
Anzahl der Segmente: 2
Lampen pro Segment: 60
Länge pro Segment: 6.00 m
1 Kette = 2 Segmente á 6.0 m



// kein Power Supply notwendig
// max. 16 Ketten koppelbar



QuickFix™ Outdoor+
Rubber 230 V | 3.5 W

3 LED String Lite® 120 – 20 m

019-003



Länge: 20 m
Anzahl der Segmente: 2
Lampen pro Segment: 60
Länge pro Segment: 10.00 m
1 Kette = 2 Segmente á 10.0 m

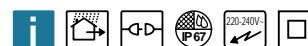

// kein Power Supply notwendig
// max. 10 Ketten koppelbar

TECHNICAL DRAWING

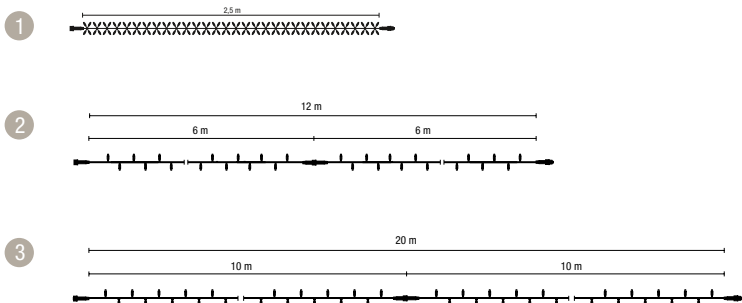



SPARKLING LIGHT

La Roca Village, Barcelona – Spain

Die zweite Generation der Premium LED verbraucht nur die halbe Leistung bei gleicher Helligkeit.

Premium Eco[®]

Segmente austauschbar
Ohne Netzstecker

// verbesserte Farbwiedergabe (High CRI > 85%)

// verbesserte optische Wirkung

// geringer Farbunterschied zur Premium LED

NEW



QuickFix™ Outdoor+
Rubber 230 V | 7 W

LED Drape Lite® 240

	019-061
	019-062
	019-063
	019-064



Dimension: 2 m x 0.4 m
Anzahl der Stränge: 30
Lampen pro Strang: 8
Länge pro Strang: 0.40 m
LED: 240



QuickFix™ Outdoor+
Rubber 230 V | 7 W

LED Drape Lite® 200

	019-065
	019-066
	019-067
	019-068



Dimension: 2 m x 1 m
Anzahl der Stränge: 20
Lampen pro Strang: 10
Länge pro Strang: 1 m
LED: 200

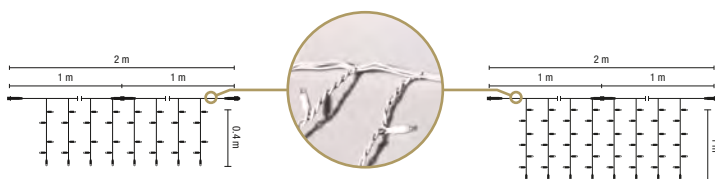

// kein Power Supply notwendig
// max. 15 Vorhänge koppelbar



// kein Power Supply notwendig
// max. 15 Vorhänge koppelbar



SPARKLING LIGHT

Stadt-Galerie Hameln – Germany

Die zweite Generation der Premium LED verbraucht nur die halbe Leistung bei gleicher Helligkeit.

Premium Eco[®]

Segmente austauschbar
Ohne Netzstecker

- // verbesserte Farbwiedergabe (High CRI > 85%)
- // verbesserte optische Wirkung
- // geringer Farbunterschied zur Premium LED



QuickFix™ Outdoor+
Rubber 230 V | 3.5 W

LED Ice Lite® 114



019-101



Dimension: 3 m x 0.5 m
Anzahl der Segmente: 2
Lampen pro Segment: 57
Länge pro Segment: 1.50 m
LED: 114

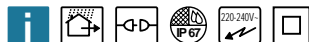
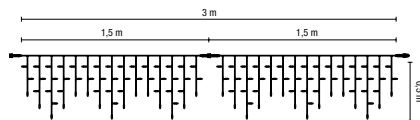

// kein Power Supply notwendig
// max. 50 Ketten koppelbar



QuickFix™ Outdoor+
Rubber 230 V | 5.2 W

LED Ice Lite® 174



019-102



Dimension: 3 m x 0.9 m
Anzahl der Segmente: 3
Lampen pro Segment: 58
Länge pro Segment: 1.00 m
LED: 174

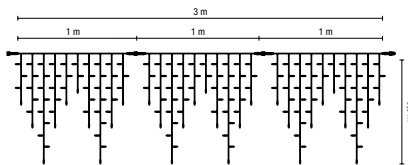

// kein Power Supply notwendig
// max. 36 Ketten koppelbar



SPARKLING LIGHT

Nörrköping – Sweden

String Lite®

90 – 4.5 m

Länge: 4.5 m
Anzahl der Segmente: 1
Lampen pro Segment: 90
Länge pro Segment: 4.50 m
LED: 90

1 Kette = 1 Segment á 4.5 m
Ohne Netzstecker

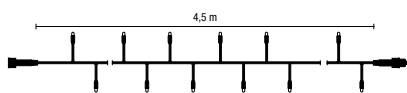



QuickFix™ Outdoor+ Rubber 230 V | 7 W



019-238



019-237



// kein Power Supply notwendig
// max. 44 Ketten koppelbar



QuickFix™ Low Voltage+ Rubber 36 V | 3.3 W



029-086



029-087

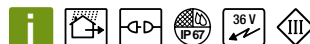

// Power Supply erforderlich
// max. 17 Ketten koppelbar
// schwarzes Gummikabel

ACCESSORIES



LED QuickFix™ Main Connector

	EU	UK	CH	AU
	001-011	001-013	001-015	001-017
	001-012	001-014	001-016	001-018

Anschluss: Zuleitung an LED QuickFix™
mit Gleichrichter,
max. Belastbarkeit: 480 W (220C)



QuickFix™ Low Voltage+ Power Supply

► Siehe Seite 135

Was kann bei Dekorationen von eng gewickelten Ästen und Bäumen passieren?

Der dekorierte Baum wächst und dehnt sich aus. Dies kann zur Folge haben, dass Kabel einer normalen Lichterkette stark gedehnt werden und reißen. Die spezielle Lichterkette String Lite® 90 ist mit Sollbruchstellen versehen die zusätzlich Kabel freigeben können und dadurch das Risiko eines Kabelbruches vermindern. Die String Lite® 90 hat eine maximale Dehnbarkeit von 25% und kann also um ¼ Ihrer Originallänge „wachsen“.

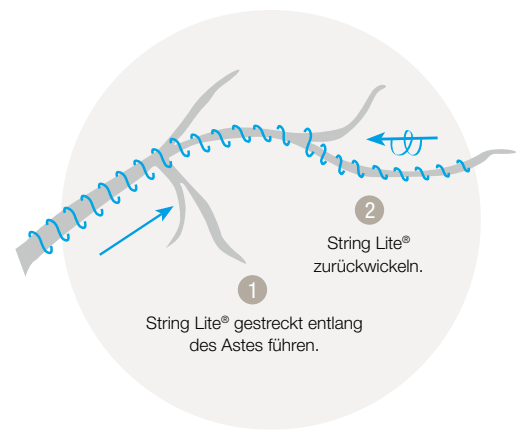



SPARKLING LIGHT

Schwarz – Austria

String Lite®

120 – 20 m

Länge: 20 m
Anzahl der Segmente: 2
Lampen pro Segment: 60
Länge pro Segment: 10.00 m
LED: 120

1 Kette = 2 Segmente á 10.0 m
Segmente austauschbar
Ohne Netzstecker

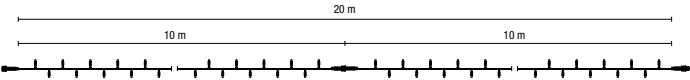



QuickFix™ Outdoor+ Rubber 230 V | 7 W

	019-309
	019-310
	019-324
	019-323
	019-360
	019-359
	019-363
	019-361
	019-362
	019-364
	019-365
	019-427

rot, grün,
amber, blau



QuickFix™ Indoor PVC 230 V | 7 W

	017-044
	017-045
	017-043



QuickFix™ Low Voltage+ PVC & Rubber 36 V | 4.3 W

	029-019
	029-024
	029-169



// kein Power Supply notwendig
// max. 10 Ketten koppelbar

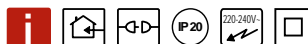

// kein Power Supply notwendig
// max. 10 Ketten koppelbar

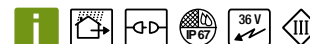

// Power Supply erforderlich
// max. 4 Ketten koppelbar

ACCESSORIES



LED QuickFix™ Main Connector

	EU	UK	CH	AU
	001-011	001-013	001-015	001-017
	001-012	001-014	001-016	001-018

Anschluss: Zuleitung an LED QuickFix™
mit Gleichrichter,
max. Belastbarkeit: 480 W (220C)



LED QuickFix™ Main Connector

	EU	UK	CH	AU
	007-012	007-014	007-016	007-018
	007-011			

Anschluss: Zuleitung an LED QuickFix™
mit Gleichrichter,
max. Belastbarkeit: 480 W (220C)



QuickFix™ Low Voltage+ Power Supply

► Siehe Seite 135



SPARKLING LIGHT

Elbepark, Dresden – Germany

String Lite®

120 – 12 m

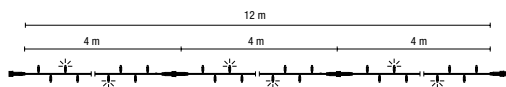
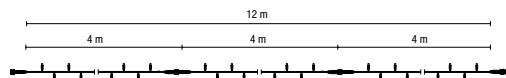

Länge: 12 m
 Anzahl der Segmente: 3
 Lampen pro Segment: 40
 Länge pro Segment: 4.00 m
 LED: 120

1 Kette = 3 Segmente á 4.0 m
 Segmente austauschbar
 Ohne Netzstecker



QuickFix™ Outdoor+ Rubber 230 V | 10.5 W

	019-311
	019-312
	019-357
	019-358

+ Blitz-LED pro Segment: 5

		019-367
		019-366
		019-328
		019-327
		019-326
		019-325



QuickFix™ Indoor PVC 230 V | 10.5 W

	017-042
	017-076
	017-041

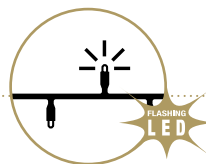

QuickFix™ Low Voltage+ PVC & Rubber 36 V | 4.3 W

	029-002
	029-167
	029-088
	029-001
	029-089
	029-071
	029-072
	029-074
	029-073
	029-116
	029-117

+ Blitz-LED pro Segment: 4

		029-048
		029-115
		029-049
		029-098

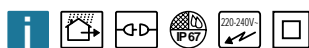

// kein Power Supply notwendig
// max. 16 Ketten koppelbar

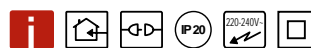

// kein Power Supply notwendig
// max. 16 Ketten koppelbar

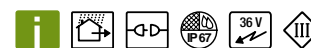

// Power Supply erforderlich
// max. 6 Ketten koppelbar

ACCESSORIES



LED QuickFix™ Main Connector

	EU	UK	CH	AU
	001-011	001-013	001-015	001-017
	001-012	001-014	001-016	001-018

Anschluss: Zuleitung an LED QuickFix™
mit Gleichrichter,
max. Belastbarkeit: 480 W (220C)



LED QuickFix™ Main Connector

	EU	UK	CH	AU
	007-012	007-014	007-016	007-018
	007-011			

Anschluss: Zuleitung an LED QuickFix™
mit Gleichrichter,
max. Belastbarkeit: 480 W (220C)



QuickFix™ Low Voltage+ Power Supply

► Siehe Seite 135

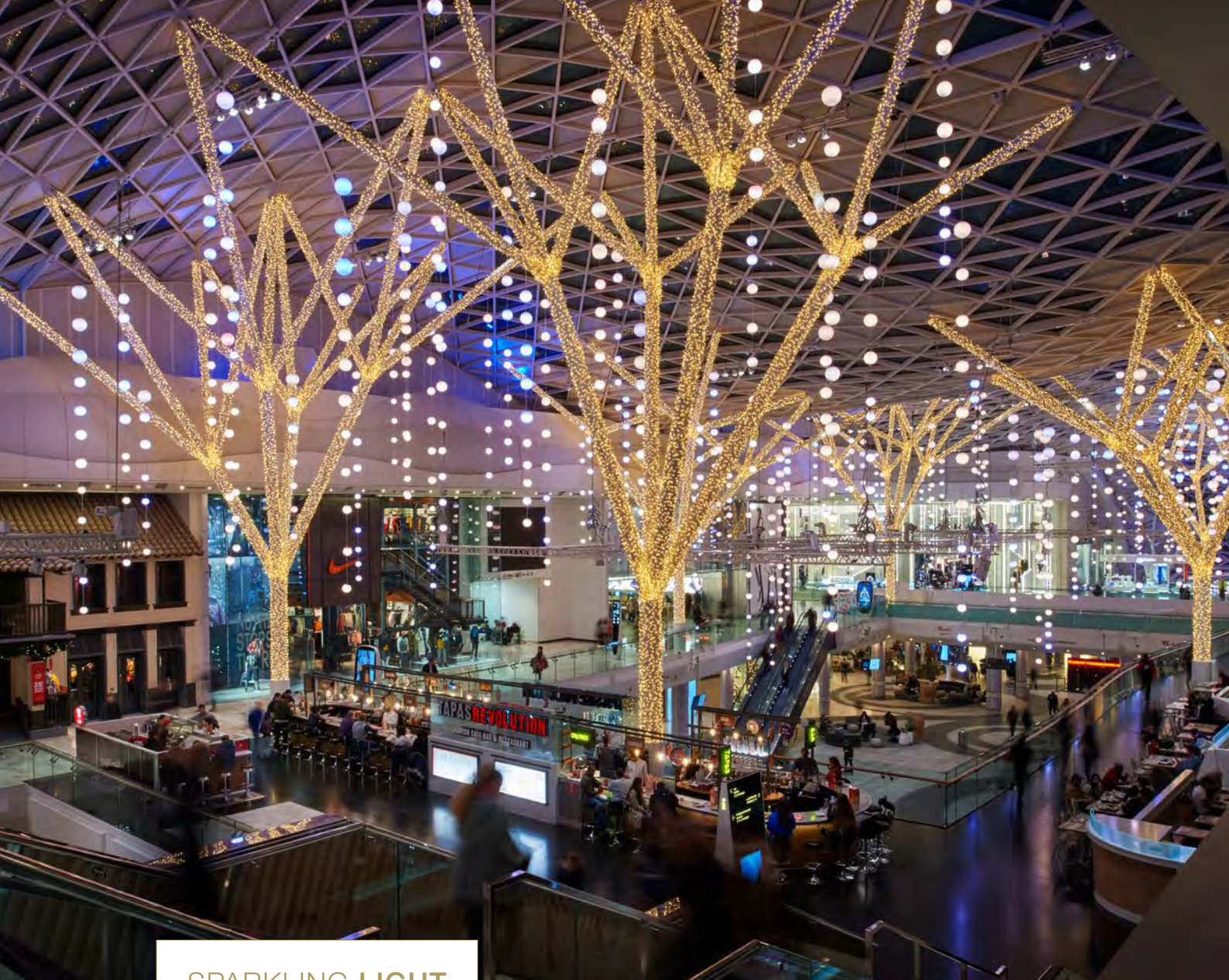

SPARKLING LIGHT

Westfield, Stratford – UK

String Lite®

160 – 8 m

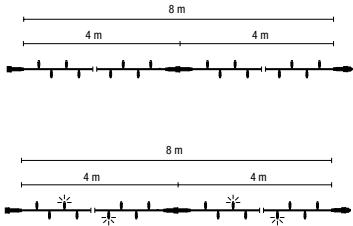

- Länge: 8 m
- Anzahl der Segmente: 2
- Lampen pro Segment: 80
- Länge pro Segment: 4.00 m
- LED: 160

1 Kette = 2 Segmente á 4.0 m
 Segmente austauschbar
 Ohne Netzstecker



QuickFix™ Outdoor+ Rubber 230 V | 14 W

	019-408
	019-368
	019-409
	019-369
	019-410
	019-411
	019-412

+ Blitz-LED pro Segment: 10
 019-403



QuickFix™ Indoor PVC 230 V | 14 W

	017-074
	017-075

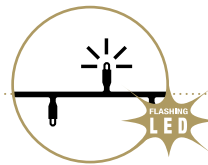

QuickFix™ Low Voltage+ PVC 36 V | 5.8 W

	029-080
	029-079
	029-076
	029-077
	029-084
	029-078

+ Blitz-LED pro Segment: 8
 029-081
 029-082



// kein Power Supply notwendig
 // max. 25 Ketten koppelbar

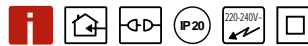

// kein Power Supply notwendig
 // max. 25 Ketten koppelbar

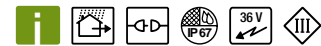

// Power Supply erforderlich
 // max. 10 Ketten koppelbar

ACCESSORIES



LED QuickFix™ Main Connector

	EU	UK	CH	AU
	001-011	001-013	001-015	001-017
	001-012	001-014	001-016	001-018

Anschluss: Zuleitung an LED QuickFix™
 mit Gleichrichter,
 max. Belastbarkeit: 480 W (220C)



LED QuickFix™ Main Connector

	EU	UK	CH	AU
	007-012	007-014	007-016	007-018
	007-011			

Anschluss: Zuleitung an LED QuickFix™
 mit Gleichrichter,
 max. Belastbarkeit: 480 W (220C)



QuickFix™ Low Voltage+ Power Supply

► Siehe Seite 135



SPARKLING LIGHT

Château de Vaux-le-Vicomte, Maincy – France

String Lite® E14

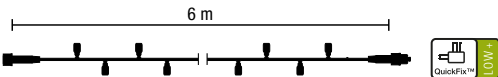
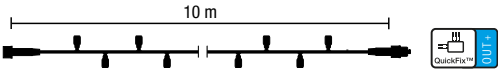

Anzahl der Segmente: 1
ohne Leuchtmittel

- // traditionelle Lichterkette
- // E14 Fassungen
- // integrierter Dichtring
- // geringer Stromverbrauch
- // mit Überbrückungssicherung – nur eine Lampe fällt aus



NEW



QuickFix™ Outdoor+ Rubber 230 V



019-313



siehe Seite 124

Länge: 10 m
Anzahl der Fassungen: 20
Länge pro Segment: 10.00 m

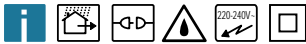

// ohne Netzstecker
// max. 20 Ketten koppelbar



QuickFix™ Low Voltage+ Rubber 36 V



029-313



siehe Seite 132

Länge: 6 m
Anzahl der Fassungen: 18
Länge pro Segment: 6.00 m

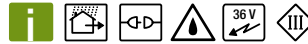

// Power Supply erforderlich
// max. 6 Ketten koppelbar

Es müssen alle Prisma Bulbs ordnungsgemäß verschraubt werden. Prisma Bulbs und Deco Golf Bälle können in einer Kette gemischt werden. Die String Lite® E14 kann direkt mit den LED String Lite® Produkten verbunden werden.

String Lite® E14

leichte und individuelle Montagemöglichkeiten durch QuickFix™ System

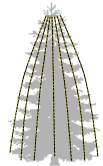

ACCESSORIES



QuickFix™ Main Connector

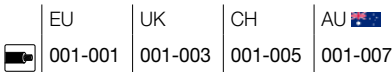

Anschluss: Zuleitung an QuickFix™
max. Belastbarkeit: 1800 W (820C)



siehe Seite 124



QuickFix™ Low Voltage+ Power Supply

► Siehe Seite 135

LED Prisma Bulb E14

LED	014-450	LED	014-448
LED	014-445	LED	014-449
LED	014-446	LED	015-022
LED	014-447	LED	015-023

12 V, 0,5 W, 0,5 VA
ca. 6 Lumen



Universal Mounting Track

014-855 10
Länge: 2.08 m

Spare Sealing Ring E14
014-148 20

Mounting Clip
015-388 Typ 1 – Gerade
015-389 Typ 2 – L-Form
 20

LED Deco Golf Ball E14 / 12V

LED 015-357
LED 015-359
12 V, 0,5 W, 0,5 VA
ca. 22 Lumen



SPARKLING LIGHT

Andermatt – Switzerland

String Lite®

10 & 20

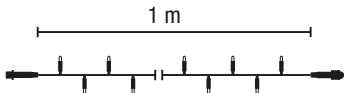

Länge: 1 m
Anzahl der Segmente: 1
Länge pro Segment: 1.00 m

1 Kette = 1 Segment á 1.0 m
Segmente austauschbar
Transparentes Kabel



QuickFix™ Low Voltage+
PVC 36 V | 0.4 W

36V LED String Lite® 10

	029-090
	029-091



QuickFix™ Low Voltage+
PVC 36 V | 0.8 W

36V LED String Lite® 20

	029-093
	029-092
	029-094
	029-095
	029-096
	029-097



Lampen pro Segment: 10
LED: 10

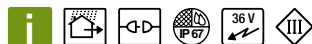

// Power Supply erforderlich
// max. 80 Ketten koppelbar

Lampen pro Segment: 20
LED: 20

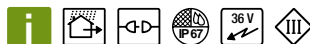

// Power Supply erforderlich
// max. 80 Ketten koppelbar

ACCESSORIES



QuickFix™ Low Voltage+
Power Supply

► Siehe Seite 135



SPARKLING LIGHT

Zwolle – Netherlands

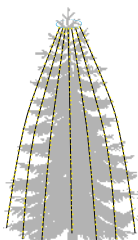

String Lite® E14
*leichte und individuelle
Montagemöglichkeiten
durch QuickFix™ System*

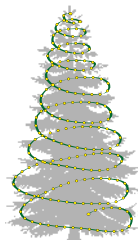

Crystal Party Lite®
*schwierige und
eingeschränkte Montage*

Crystal Party Lite® Kit

Gummiflachbandkabel mit E27
Fassungen – vormontiert
exkl. Lampen (max. 15W)

traditionelle Lichterkette
E27 Fassungen
integrierter Dichtring



Outdoor+
E27 / 230 V

Crystal Party Lite® Kit 100 / 50

	112-113
	112-119
	112-117

+ Fassungen: 100
Länge: 50 m
max. Belastbarkeit: 1500 W



Outdoor+
E27 / 230 V

Crystal Party Lite® Kit 150 / 50

	112-116
	112-121
	112-118

+ Fassungen: 150
Länge: 50 m
max. Belastbarkeit: 2250 W



Outdoor+
E27 / 230 V

Crystal Party Lite® Kit 200 / 100

	112-025
	112-120
	112-022

+ Fassungen: 200
Länge: 100 m
max. Belastbarkeit: 3000 W



ACCESSORIES

Sealing Ring



1 Dichtring innenliegend

	244-252
	244-201



2 Dichtmanschette außenliegend

	244-251
	244-250

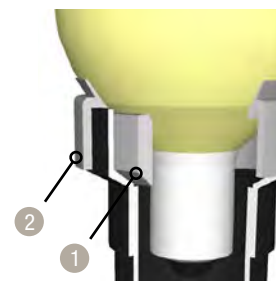

NEW! LED Deco Golf Ball 3.0 COB

	013-125
--	---------

Tropfenformlampe,
COB LED: 1, 85 Lumen
220-240 V, 0.9 W, 1 VA



	013-126
--	---------

Tropfenformlampe,
COB LED: 2, 170 Lumen
220-240 V, 1.7 W, 2 VA



LED Golf Ball
▶ Siehe Seite 69

LED Flash
▶ Siehe Seite 69

LED Golf Ball E27

	014-106
	014-100
	014-101
	014-102
	014-103
	014-104
	014-105

LED Tropfenformlampe,
LED: 12, 220-240 V, 1 W, 5.5 VA



LED Deco Golf Ball 2 E27

	015-218
	015-219

Tropfenformlampe,
LED: 9, 220-240 V, 0.85 W, 5.5 VA





SPARKLING LIGHT

Toronto – Canada

NEW

String Lite® E27

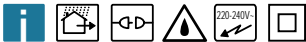

Gummikabel mit E27 Fassungen
 Länge 10 m
 Fassungen – vormontiert
 exkl. Lampen (max. 10 W / VA)

20 x E27 Fassungen

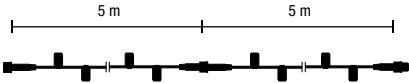

NEW!



QuickFix™ Outdoor+
E27 / 230 V

String Lite® E27



019-314



- + Fassungen: 20
- Länge: 10 m
- max. Belastbarkeit: 20 x 10 W / VA
- max. koppelbar: 7 Ketten (à 20 x 5.5 W / VA)

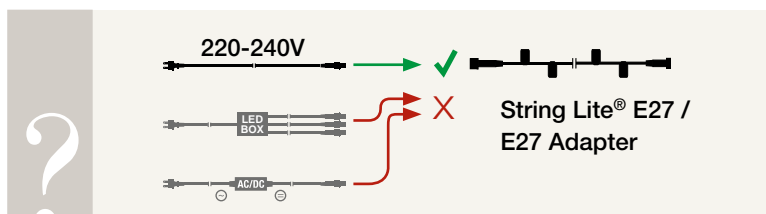

NEW!



QuickFix™ Outdoor+
E27 / 230 V

E27 Adapter



001-138



- + Fassungen: 1
- Länge: 36.5 cm
- max. Belastbarkeit: 10 W / VA



ACCESSORIES

NEW! **LED Deco Golf Ball 3.0 COB**



013-125



Tropfenformlampe,
COB LED: 1, 85 Lumen
220-240 V, 0.9 W, 1 VA



013-126



Tropfenformlampe,
COB LED: 2, 170 Lumen
220-240 V, 1.7 W, 2 VA



LED Golf Ball

► Siehe Seite 69

LED Flash

► Siehe Seite 69

LED Golf Ball E27



014-106



014-100



014-101



014-102



014-103



014-104



014-105

LED Tropfenformlampe,
LED: 12, 220-240 V, 1 W, 5.5 VA



LED Deco Golf Ball 2 E27



015-218



015-219

Tropfenformlampe,
LED: 9, 220-240 V, 0.85 W, 5.5 VA





SPARKLING LIGHT

Kitzbühel – Austria

Magic String Lite®

120

- Länge: 2.5 m
- Anzahl der Segmente: 1
- Lampen pro Segment: 120
- Länge pro Segment: 2.50 m
- LED: 120

1 Kette = 1 Segment á 2.5 m

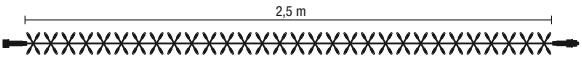



QuickFix™ Outdoor+ Rubber 230 V | 7 W

	LED	019-419
	LED	019-406
	LED	019-420
	LED	019-407



// kein Power Supply notwendig
 // max. 62 Ketten koppelbar
 // ohne Netzstecker



QuickFix™ Low Voltage+ PVC 36 V | 4.3 W

	LED	029-111
	LED	029-109

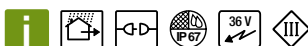

// Power Supply erforderlich
 // max. 30 Ketten koppelbar

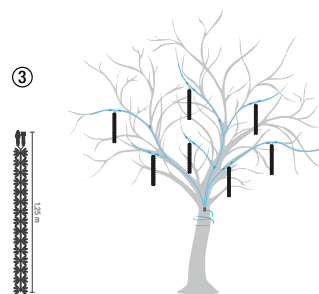
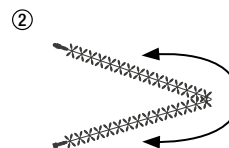
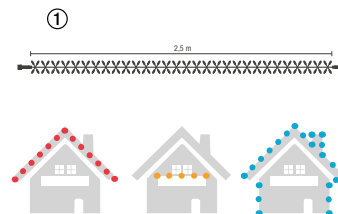

ACCESSORIES



LED QuickFix™ Main Connector

	EU	UK	CH	AU
	001-011	001-013	001-015	001-017
	001-012	001-014	001-016	001-018

Anschluss: Zuleitung an LED QuickFix™
 mit Gleichrichter,
 max. Belastbarkeit: 480 W (220C)



QuickFix™ Low Voltage+ Power Supply

▶ Siehe Seite 135



SPARKLING LIGHT

A-ROSA Kitzbühel – Austria

Magic String Lite®

144

Länge: 6 m
Anzahl der Segmente: 1
Lampen pro Segment: 144
Länge pro Segment: 6.00 m
LED: 144

1 Kette = 1 Segment á 6.0 m
Ohne Netzstecker

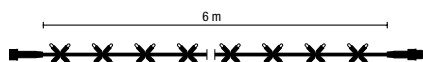



QuickFix™ Outdoor+
Rubber 230 V | 7 W

	LED	019-428
	LED	019-404
	LED	019-429
	LED	019-405

3.5 6 10
siehe Seite 124

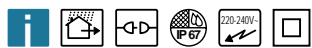

// kein Power Supply notwendig
// max. 33 Ketten koppelbar

ACCESSORIES



LED QuickFix™ Main Connector

	EU	UK	CH	AU
	001-011	001-013	001-015	001-017
	001-012	001-014	001-016	001-018



Anschluss: Zuleitung an LED QuickFix™
mit Gleichrichter,
max. Belastbarkeit: 480 W (220C)

220 5 30
siehe Seite 124





SPARKLING LIGHT

Intu Bromley – UK

Magic String Lite®

240 & 60



1 Kette = 1 Segment á 5.0 m
Ohne Netzstecker

Wunderschöne
Konturen-
beleuchtung.



QuickFix™ Indoor
PVC 230 V | 14 W

Magic String Lite® 240

	LED	017-065
	LED	017-066



Länge: 5 m
Anzahl der Segmente: 1
Lampen pro Segment: 240
Länge pro Segment: 5.00 m
LED: 240

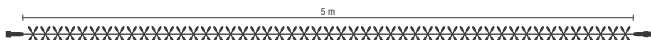

QuickFix™ Indoor
PVC 230 V | 3.5 W

Magic String Lite® 60

	LED	017-071
	LED	017-072



Länge: 1.25 m
Anzahl der Segmente: 1
Lampen pro Segment: 60
Länge pro Segment: 1.25 m
LED: 60

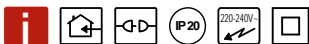

// kein Power Supply notwendig
// max. 31 Ketten koppelbar

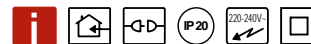

// kein Power Supply notwendig
// max. 125 Ketten koppelbar

ACCESSORIES



LED QuickFix™ Main Connector Indoor

	EU		UK		CH		AU
	007-012		007-014		007-016		007-018

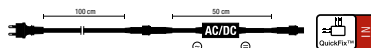

Anschluss: Zuleitung an LED QuickFix™ mit Gleichrichter,
max. Belastbarkeit: 480 W (220C)





SPARKLING LIGHT

Bürgenstock Resort, Lucerne – Switzerland

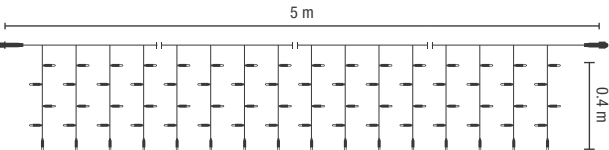
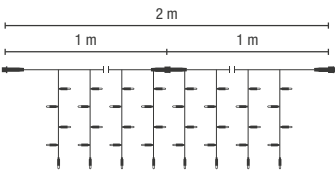

Drape Lite®

0.4 m & 1 m

Transparentes Kabel
Ohne Netzstecker



QuickFix™ Indoor
PVC 230 V | 14 W

LED Drape Lite® 240

	017-069
	017-070



Dimension: 2 m x 0.4 m
Anzahl der Stränge: 30
Lampen pro Strang: 8
Länge pro Strang: 0.40 m
LED: 240



QuickFix™ Indoor
PVC 230 V | 35 W

LED Drape Lite® 600

	017-067
	017-068



Dimension: 5 m x 0.4 m
Anzahl der Stränge: 75
Lampen pro Strang: 8
Länge pro Strang: 0.40 m
LED: 600



QuickFix™ Low Voltage+
PVC 36 V | 5 W

36V LED Drape Lite® 140

	029-128
	029-129



Dimension: 2 m x 1 m
Anzahl der Stränge: 20
Lampen pro Strang: 7
Länge pro Strang: 1.00 m
LED: 140

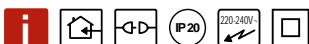
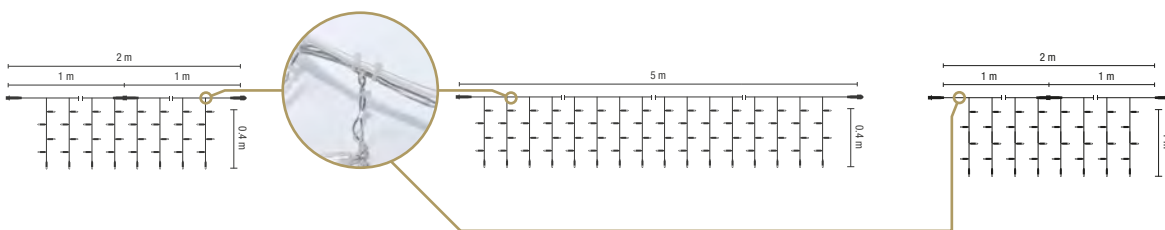

// kein Power Supply notwendig
// Segmente austauschbar
// max. 25 Vorhänge koppelbar

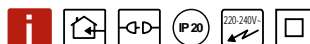

// kein Power Supply notwendig
// Segmente austauschbar
// max. 12 Vorhänge koppelbar

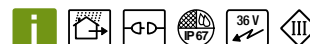

// Power Supply erforderlich
// Segmente austauschbar
// max. 6 Vorhänge koppelbar

ACCESSORIES



LED QuickFix™ Main Connector Indoor

EU	UK	CH	AU
007-012	007-014	007-016	007-018

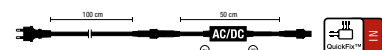

Anschluss: Zuleitung an LED QuickFix™ mit Gleichrichter,
max. Belastbarkeit: 480 W (220C)



QuickFix™ Low Voltage+ Power Supply

► Siehe Seite 135



SPARKLING LIGHT

Fünf Höfe, München – Germany

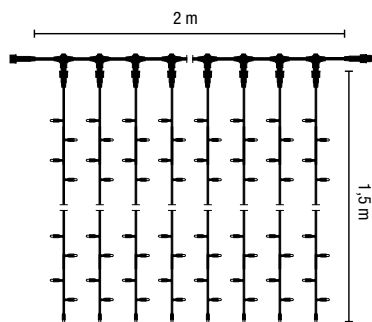

Drape Lite®

1.5 m

Dimension: 2 m x 1.5 m
 Anzahl der Stränge: 20
 Länge pro Strang: 1.50 m



2 Strang = 1 Serie
 Lampen pro Strang: 15



Lampen pro Strang: 10



QuickFix™ Outdoor+ Rubber 230 V | 35 W

LED Drape Lite® 300

	019-329 019-905 Ersatzstrang 1.5 m
	019-330 019-906 Ersatzstrang 1.5 m
	019-335 019-903 Ersatzstrang 1.5 m
	019-430 019-900 Ersatzstrang 1.5 m
	019-373 019-904 Ersatzstrang 1.5 m
	019-374 019-907 Ersatzstrang 1.5 m

+ Blitz-LED pro Segment: 2

		019-339 019-909 Ersatzstrang 1.5 m
		019-431 019-901 Ersatzstrang 1.5 m
		019-338 019-908 Ersatzstrang 1.5 m
		019-423 019-902 Ersatzstrang 1.5 m

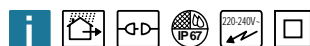

// kein Power Supply notwendig
 // Stränge austauschbar
 // max. 12 Vorhänge koppelbar
 // Stränge sind nicht QuickFix™ kompatibel und nicht verlängerbar



QuickFix™ Indoor PVC 230 V | 35 W

LED Drape Lite® 300

	017-046 014-942 Ersatzstrang 1.5 m
	017-055 015-315 Ersatzstrang 1.5 m

+ Blitz-LED pro Segment: 2

		017-058 015-318 Ersatzstrang 1.5 m
--	--	--

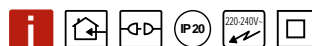
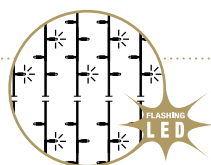

// kein Power Supply notwendig
 // Stränge austauschbar
 // max. 12 Vorhänge koppelbar
 // Stränge sind nicht QuickFix™ kompatibel und nicht verlängerbar



QuickFix™ Low Voltage+ PVC 36 V | 7.2 W

36V LED Drape Lite® 200

	029-004
	029-003

+ Blitz-LED pro Segment: 1

		029-052
		029-112

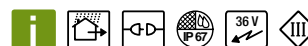
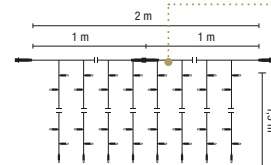

// Power Supply erforderlich
 // Segmente austauschbar
 // max. 6 Vorhänge koppelbar

ACCESSORIES (QuickFix™ Outdoor & Indoor)

Universal Mounting Track

014-855
 Länge: 2.08 m
 Produkt für Drape Lite®,
 Divider und E14 String Lite®

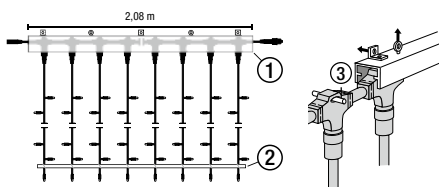

- ① Alu-Schiene
- ② Fixierungsstange mit Kabelbinder
- ③ Kunststoffbolzen

Spare-Pin for Mounting Track

015-367 ③
 Verpackungsinhalt: 20



Endcap-set for Drape Lite®

015-361 ① 30
 2x transparente Verschlusskappe für Drape
 Lite® Strang Indoor/Outdoor
 2x Schrumpfschlauch transparent, weiß und
 schwarz
 2x Dichtring





SPARKLING LIGHT

Esslingen – Germany

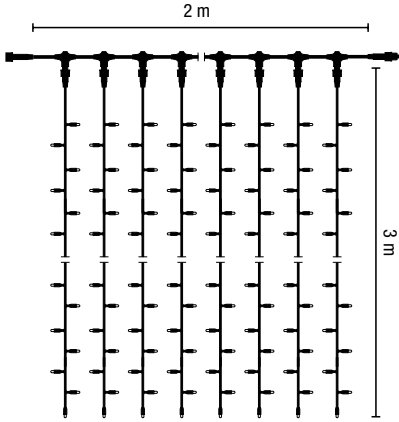

Drape Lite®

3 m

Dimension: 2 m x 3 m
 Anzahl der Stränge: 20
 Länge pro Strang: 3.00 m
 Ohne Netzstecker



2 Strang = 1 Serie
 Lampen pro Strang: 30



Lampen pro Strang: 20



QuickFix™ Outdoor+
Rubber 230 V | 35 W

Drape Lite® 600

	019-331
	019-915 Ersatzstrang 3.0 m
	019-332
	019-916 Ersatzstrang 3.0 m
	019-336
	019-913 Ersatzstrang 3.0 m
	019-432
	019-910 Ersatzstrang 3.0 m
	019-378
	019-914 Ersatzstrang 3.0 m

+ Blitz-LED pro Segment: 4

		019-341
		019-918 Ersatzstrang 3.0 m
		019-433
		019-911 Ersatzstrang 3.0 m
		019-340
		019-917 Ersatzstrang 3.0 m
		019-434
		019-912 Ersatzstrang 3.0 m



- // kein Power Supply notwendig
- // Stränge austauschbar
- // max. 12 Vorhänge koppelbar
- // Stränge sind nicht QuickFix™ kompatibel und nicht verlängerbar



QuickFix™ Indoor
PVC 230 V | 35 W

Drape Lite® 600

	017-047	
	014-943 Ersatzstrang 3.0 m	
	017-056	
	015-316 Ersatzstrang 3.0 m	
+ Blitz-LED pro Segment: 4		
		017-059
		015-319 Ersatzstrang 3.0 m

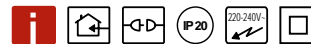

- // kein Power Supply notwendig
- // Stränge austauschbar
- // max. 12 Vorhänge koppelbar
- // Stränge sind nicht QuickFix™ kompatibel und nicht verlängerbar



QuickFix™ Low Voltage+
PVC 36 V | 14.4 W

Drape Lite® 400

	029-067
	029-068

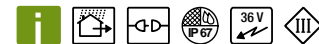
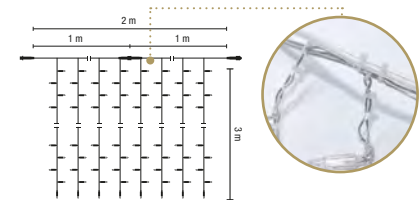

- // Power Supply erforderlich
- // Segmente austauschbar
- // max. 4 Vorhänge koppelbar

ACCESSORIES (QuickFix™ Outdoor & Indoor)

Universal Mounting Track

014-855

Länge: 2.08 m
Produkt für Drape Lite®,
Divider und E14 String Lite®

- ① Alu-Schiene
- ② Fixierungsstange mit Kabelbinder
- ③ Kunststoffbolzen

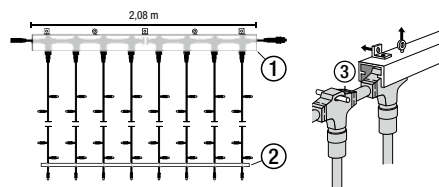

Endcap-set for Drape Lite®

015-361

- 2x transparente Verschlusskappe für Drape Lite® Strang Indoor/Outdoor
- 2x Schrumpfschlauch transparent, weiß und schwarz
- 2x Dichtring





SPARKLING LIGHT

Blautal Center, Ulm – Germany

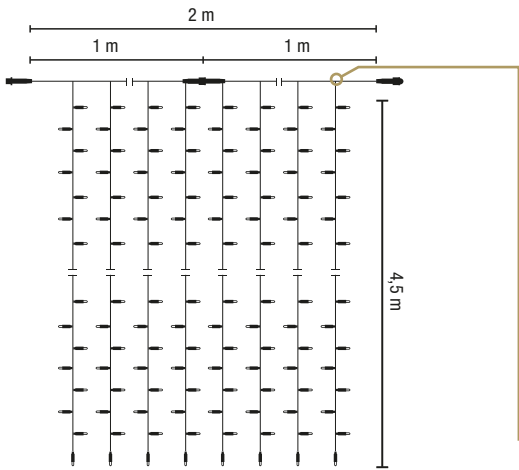

Drape Lite®

4.5 m

- Dimension: 2 m x 4.5 m
- Anzahl der Stränge: 20
- Lampen pro Strang: 30
- Länge pro Strang: 4.50 m
- LED: 600





QuickFix™ Low Voltage+
PVC 36 V | 21.6 W

36V LED Drape Lite® 600



029-139



029-140



siehe Seite 132



- // Power Supply erforderlich
- // Segmente austauschbar
- // max. 2 Vorhänge koppelbar

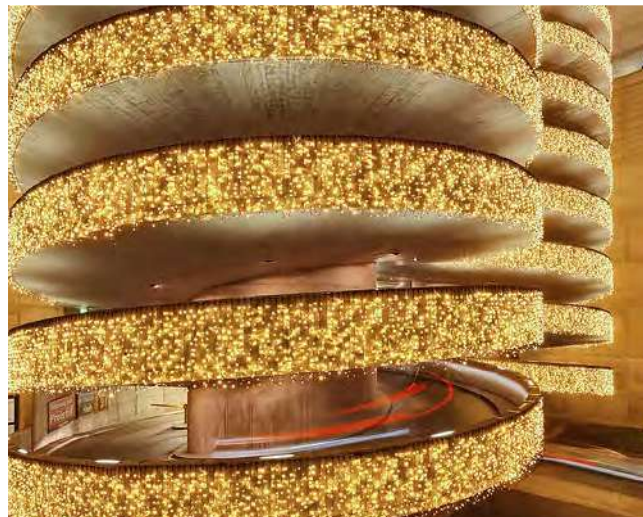

ACCESSORIES



QuickFix™ Low Voltage+
Power Supply

► Siehe Seite 135



SPARKLING LIGHT

Sello, Espoo – Finland

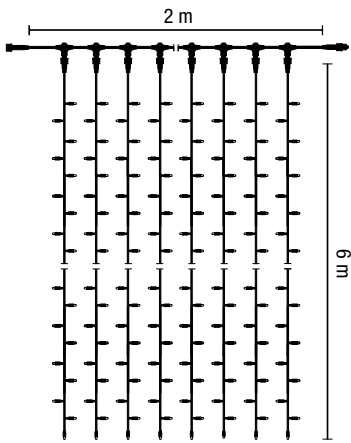

Drape Lite®

6 m

Dimension: 2 m x 6 m
 Anzahl der Stränge: 20
 Länge pro Strang: 6.00 m
 Ohne Netzstecker



1 Strang = 1 Serie
 Lampen pro Strang: 60



Lampen pro Strang: 40



QuickFix™ Outdoor+ Rubber 230 V | 70 W

LED Drape Lite® 1200

	019-333
	019-919 Ersatzstrang 6.0 m
	019-334
	019-921 Ersatzstrang 6.0 m
	019-337
	019-920 Ersatzstrang 6.0 m
	019-441
	019-922 Ersatzstrang 6.0 m



QuickFix™ Indoor PVC 230 V | 70 W

LED Drape Lite® 1200

	017-040
	015-063 Ersatzstrang 6.0 m
	017-057
	015-317 Ersatzstrang 6.0 m
	017-060
	015-320 Ersatzstrang 6.0 m

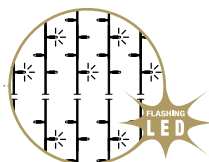

QuickFix™ Low Voltage+ PVC 36 V | 28.8 W

36V LED Drape Lite® 800

	029-069
	029-070

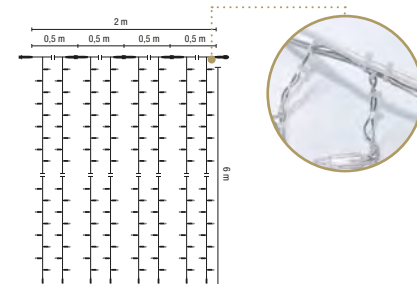

- // kein Power Supply notwendig
- // Stränge austauschbar
- // max. 6 Vorhänge koppelbar
- // Stränge sind nicht QuickFix™ kompatibel und nicht verlängerbar

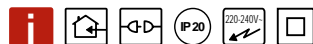

- // kein Power Supply notwendig
- // Stränge austauschbar
- // max. 6 Vorhänge koppelbar
- // Stränge sind nicht QuickFix™ kompatibel und nicht verlängerbar

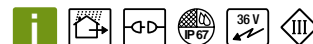

- // Power Supply erforderlich
- // Segmente austauschbar
- // max. 2 Vorhänge koppelbar
- // transparentes Kabel

ACCESSORIES



LED QuickFix™ Main Connector

	EU	UK	CH	AU
	001-011	001-013	001-015	001-017
	001-012	001-014	001-016	001-018

Anschluss: Zuleitung an LED QuickFix™ mit Gleichrichter, max. Belastbarkeit: 480 W (220C)



LED QuickFix™ Main Connector Indoor

	EU	UK	CH	AU
	007-012	007-014	007-016	007-018

Anschluss: Zuleitung an LED QuickFix™ mit Gleichrichter, max. Belastbarkeit: 480 W (220C)



QuickFix™ Low Voltage+ Power Supply

► Siehe Seite 135

Endcap-set for Drape Lite® (QuickFix™ Outdoor & Indoor)

	015-361		1
--	---------	--	---

2x transparente Verschlusskappe für Drape Lite® Strang Indoor/Outdoor
2x Schrumpfschlauch transparent, weiß und schwarz
2x Dichtring



Universal Mounting Track (QuickFix™ Outdoor & Indoor)

014-855

Länge: 2.08 m
Produkt für Drape Lite®, Divider und E14 String Lite®

- ① Alu-Schiene
- ② Fixierungsstange mit Kabelbinder
- ③ Kunststoffbolzen

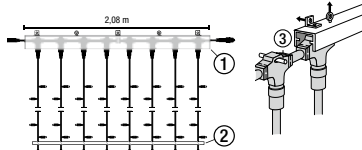



SPARKLING LIGHT

Seefeld – Austria

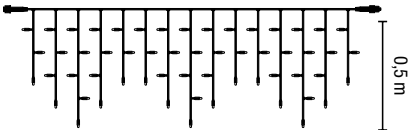

Ice Lite®

0.5 m

Segmente austauschbar
Ohne Netzstecker



QuickFix™ Outdoor+ Rubber 230 V | 7 W

Ice Lite® 114

	LED	019-342
	LED	019-343
	LED	019-348
	LED	019-435
	LED	019-390

+ Blitz-LED pro Segment: 6

	LED		019-398
	LED		019-352
	LED		019-436
	LED		019-353
	LED		019-437

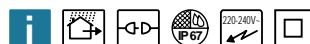

// kein Power Supply notwendig
// max. 50 Ketten koppelbar

Dimension: 3 m x 0,5 m
Anzahl der Segmente: 2
Lampen pro Segment: 57
Länge pro Segment: 1,50 m
LED: 114

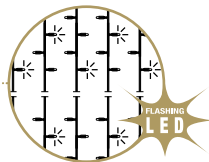
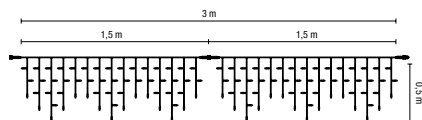

QuickFix™ Low Voltage+ Rubber 36 V | 3 W

Ice Lite® 80

	LED	029-118
	LED	029-119



Dimension: 2 m x 0,5 m
Anzahl der Segmente: 2
Lampen pro Segment: 40
Länge pro Segment: 1,00 m
LED: 80

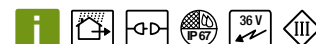
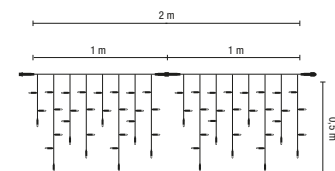

// Power Supply erforderlich
// max. 22 Ketten koppelbar

ACCESSORIES



LED QuickFix™ Main Connector

	EU	UK	CH	AU
	001-011	001-013	001-015	001-017
	001-012	001-014	001-016	001-018

Anschluss: Zuleitung an LED QuickFix™
mit Gleichrichter,
max. Belastbarkeit: 480 W (220C)



QuickFix™ Low Voltage+ Power Supply

► Siehe Seite 135



SPARKLING LIGHT

Linköping – Sweden

Ice Lite®

0.9 m

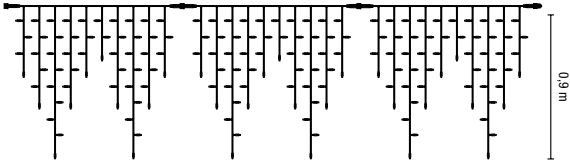

Länge pro Segment: 1.00 m

Segmente austauschbar
Ohne Netzstecker



QuickFix™ Outdoor+ Rubber 230 V | 10.5 W

LED Ice Lite® 174

	LED	019-344
	LED	019-345
	LED	019-349
	LED	019-438

+ Blitz-LED pro Segment: 8

	LED		019-400
	LED		019-351
	LED		019-439
	LED		019-350
	LED		019-440



Dimension: 3 m x 0.9 m
Anzahl der Segmente: 3
Lampen pro Segment: 58
LED: 174

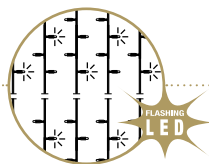
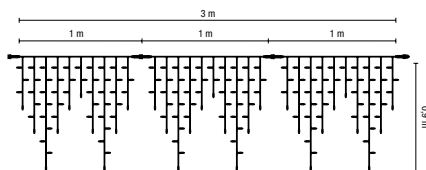

QuickFix™ Low Voltage+ PVC 36 V | 4.3 W

36V LED ice Lite® 120

	LED	029-010
	LED	029-009

+ Blitz-LED pro Segment: 6

	LED		029-113
	LED		029-056



Dimension: 2 m x 0.9 m
Anzahl der Segmente: 2
Lampen pro Segment: 60
LED: 120

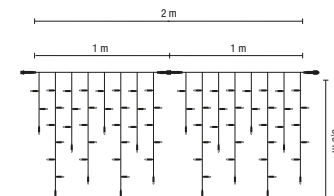

// Power Supply erforderlich
// max. 16 Ketten koppelbar



// kein Power Supply notwendig
// max. 36 Ketten koppelbar
// ohne Netzstecker

ACCESSORIES



LED QuickFix™ Main Connector

	EU	UK	CH	AU
	001-011	001-013	001-015	001-017
	001-012	001-014	001-016	001-018

Anschluss: Zuleitung an LED QuickFix™
mit Gleichrichter,
max. Belastbarkeit: 480 W (220C)



QuickFix™ Low Voltage+ Power Supply

▶ Siehe Seite 135



SPARKLING LIGHT

Kitzbühel – Austria

Giant Ice Lite®

1.5 m

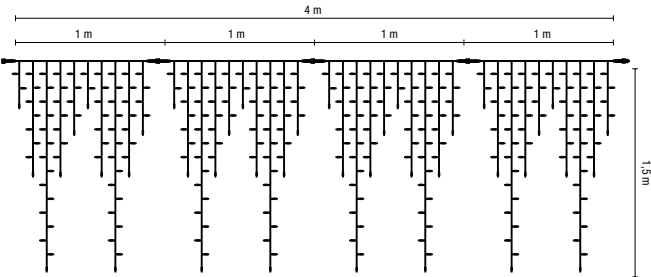

Dimension: 4 m x 1.5 m
Anzahl der Segmente: 4
Länge pro Segment: 1.00 m

Segmente austauschbar
Ohne Netzstecker



QuickFix™ Outdoor+
Rubber 230 V | 14 W

Giant Ice Lite® 304

	LED	019-346
	LED	019-347
	LED	019-396
	LED	019-397



Lampen pro Segment: 76
LED: 304

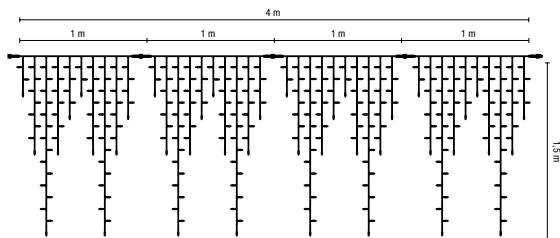

// kein Power Supply notwendig
// max. 26 Ketten koppelbar

ACCESSORIES



LED QuickFix™ Main Connector

	EU	UK	CH	AU
	001-011	001-013	001-015	001-017
	001-012	001-014	001-016	001-018

Anschluss: Zuleitung an LED QuickFix™
mit Gleichrichter,
max. Belastbarkeit: 480 W (220C)



QuickFix™ Low Voltage+
PVC 36 V | 8.6 W

36V Giant ice Lite® 240

	LED	029-058
	LED	029-059

+ Blitz-LED pro Segment: 6

	LED		029-114
	LED		029-060



Lampen pro Segment: 60
LED: 240

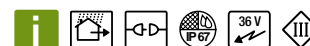
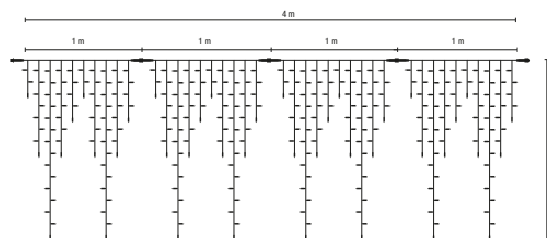
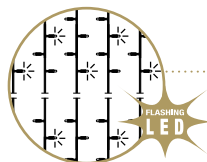

// Power Supply erforderlich
// max. 8 Ketten koppelbar



QuickFix™ Low Voltage+
Power Supply

► Siehe Seite 135



SPARKLING LIGHT

Château de Vaux-le-Vicomte, Maincy – France

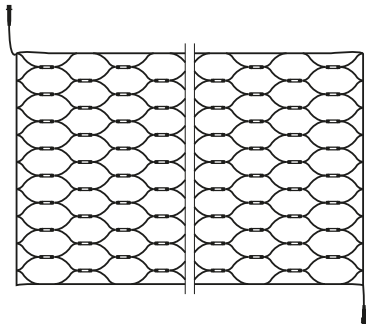

Mesh Lite

96 & 200

Anzahl der Segmente: 1
Ohne Netzstecker

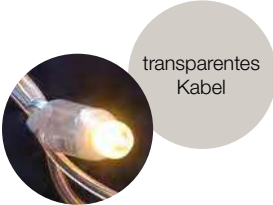



QuickFix™ Low Voltage+
PVC & Rubber 36 V | 3.6 W

36V Mesh Lite® 96

	LED	029-012
	LED	029-150
	LED	029-011
	LED	029-149



Dimension: 2 m x 1 m
Lampen pro Segment: 96
Länge pro Segment: 2.00 m
LED: 96

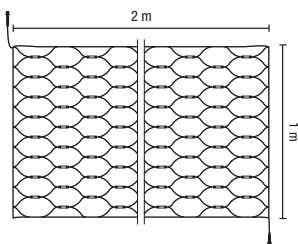

// Power Supply erforderlich
// max. 13 Netze koppelbar



QuickFix™ Low Voltage+
PVC & Rubber 36 V | 7.2 W

36V Mesh Lite® 200

	LED	029-014
	LED	029-152
	LED	029-013
	LED	029-151



Dimension: 4 m x 2 m
Lampen pro Segment: 200
Länge pro Segment: 4.00 m
LED: 200

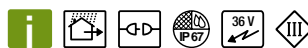
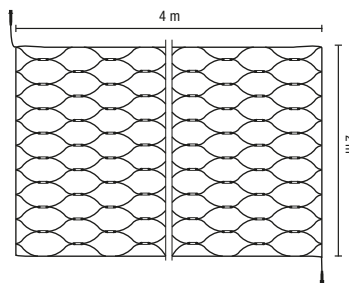

// Power Supply erforderlich
// max. 6 Netze koppelbar

ACCESSORIES



QuickFix™ Low Voltage+
Power Supply

► Siehe Seite 135





SPARKLING LIGHT

Sundbyberg – Sweden

Firework

160

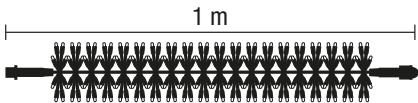

Länge: 1 m
Anzahl der Segmente: 1
Lampen pro Segment: 160
Länge pro Segment: 1.00 m
LED: 160



QuickFix™ Low Voltage+
PVC 36 V | 5.8 W



029-064



029-065



— siehe Seite 132 —

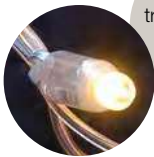

transparentes
Kabel

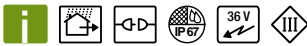

// Power Supply erforderlich
// max. 33 Ketten koppelbar

ACCESSORIES



QuickFix™ Low Voltage+
Power Supply

► Siehe Seite 135





SPARKLING LIGHT

Zwolle – Netherlands

Montagetipp für den Außenbereich:
Bevor Sie LED Lampen im Außenbereich montieren, überprüfen Sie immer, ob die Lampenfassungen für den Außenbereich zugelassen sind. Prüfen Sie außerdem ob diese dicht sind bzw. ob die richtigen Dichtringe vorhanden sind. Ersetzen Sie gebrauchte immer durch neue.

Bulbs

E27

professionelle Outdoor & Indoor Qualität
einzigartiges warm-weiss
220-240 V AC



NEW

LED Deco Golf Ball 3.0 COB

LED 013-125

Tropfenformlampe,
COB LED: 1, 85 Lumen
220-240 V, 0,9 W, 1 VA



LED 013-126

Tropfenformlampe,
COB LED: 2, 170 Lumen
220-240 V, 1,7 W, 2 VA



LED Deco Golf Ball 2 E27

LED 015-218

LED 015-219

Tropfenformlampe,
LED: 9, 220-240 V, 0,85 W, 5,5 VA



LED Deco Golf Ball

LED 015-078

LED 015-080

LED 015-079

LED 015-081

Tropfenformlampe,
LED: 7, 220-240 V, 0,7 W, 5,5 VA



Mehr Helligkeit bei geringerem Stromverbrauch.

Durch unsere neueste Chip on Board (COB) LED-Technologie erreicht der Deco Golf Ball jetzt 85 lm / 0,9 W bei einem LED-Stab sowie 170 lm / 1,7 W bei zwei LED-Stäben. Mit einem Powerfaktor, der größer als 0,85 ist, ergibt sich mehr Effizienz und eine geringere Scheinleistung. Die Bauform ist unverändert, wodurch weiterhin eine optimale Dichtheit zu den Lampenfassungen garantiert werden kann.

85/170 Lumen, warmweiß 2250 Kelvin, nicht dimmbar

Neue Generation: Der Deco Golf 2.0 mit den neun LEDs im Inneren leuchtet er jetzt noch heller. Durch die Kugelform, mit der schwarzen, konischen Fassung, passt er sich besonders gut an den Dichtungsring verschiedener, marktüblicher Fassungen an. Der schwarze, konische Ring ist optisch kaum von der Fassung zu unterscheiden. Dem Betrachter fällt somit in erster Linie die warmweiße Lichtfarbe ins Auge.

Konfiguration: Erhältlich nur in warmweißer Lichtfarbe und mit mattem oder klarem Polycarbonatgehäuse. Bestens geeignet zur Umrüstung von Classic Motiven oder anderen E27 Lampen auf energiesparende LED Technik im Innen- sowie Außenbereich.

ca. 24 Lumen, warmweiß 2500 Kelvin, nicht dimmbar

Der Deco Golf Ball ist mit seiner etwas geringeren Leuchtkraft und normalen Kugelform die günstigere Variante. Er schaut zwar der Kugelglühbirne am ähnlichsten hat allerdings nicht für alle unterschiedlichen marktüblichen Fassungen die optimale Passform. Der Deco Golf Ball ist mit warmweißer oder brillantweißer Lichtfarbe, mit mattem oder klarem Polycarbonatgehäuse erhältlich.

Achtung: Bei Außenanwendung muss eine passende Fassung samt Silikon Dichtring verwendet werden.

ca. 20 Lumen und 7 LED's, warmweiß 2500 Kelvin, nicht dimmbar



SPARKLING LIGHT

Ehrwald – Austria

Bulbs

E27

professionelle Outdoor & Indoor Qualität
einzigartiges warm-weiss
220-240 V AC





LED Golf Ball

		014-106
		014-100
		014-101
		014-102
		014-103
		014-104
		014-105

Durch die spezielle Form besitzt der Golf Ball mehr Oberfläche als herkömmliche LED-Leuchtmittel und gibt daher auch mehr Licht ab und überzeugt durch ein herausragendes Preis-Leistungsverhältnis. Das Gehäuse besteht aus mattem oder klarem Polycarbonat, ist somit extrem widerstandsfähig und bruchsicher. Die konische Form des Sockels passt sich besonders gut dem Dichtungsring verschiedener, marktüblicher Fassungen an. Somit bestens für den Innen- sowie Außenbereich geeignet.

ca. 25 Lumen, warmweiß 2500 Kelvin, nicht dimmbar

LED Tropfenformlampe,
LED: 12, 220-240 V, 1 W, 5.5 VA



LED Flash

		015-691
		015-722

Diese LEDs oder Strobes blinken in regelmäßigen Abständen kurz auf und simulieren so perfekte „Lichtblitze“, die gerne für Baum- und Fassadendekorationen verwendet werden. Selbstredend, dass damit jedes Motiv alle Aufmerksamkeit auf sich zieht.

Jetzt neu mit 9 extrahellen SMD LEDs!

Blitzrate 1-2 Blitze pro Sekunde
SMD-LED: 9, 220-240 V AC, 1 W,
Lebensdauer: min. 5000 Stunden





SPARKLING LIGHT

Zwolle – Netherlands



Bulbs

E14

professionelle Outdoor & Indoor Qualität
einzigartiges warm-weiss
12 V AC / DC





LED Prisma Bulb

	014-450 LED: 5, 12V AC/DC
	014-445 LED: 5, 12V AC/DC
	014-446 LED: 5, 12V AC/DC
	014-447 LED: 5, 12V AC/DC
	014-448 LED: 5, 12V AC/DC
	014-449 LED: 5, 12V AC/DC
	015-022 LED: 5, 12V AC
	015-023 LED: 6, 12V AC

12 V, 0,5 W, 0,5 VA



Wird seit geraumer Zeit gerne als Ersatzleuchtmittel für herkömmliche Glühbirnen bei traditionellen E14 Motiven verwendet. Die Prisma-LED ist in verschiedenen Farben erhältlich und besticht durch das einzigartige Diamantschliff Polycarbonatgehäuse, das ein brillantes Licht entstehen lässt. Zusätzlich sind Prisma-LEDs als Flash-Lights und als RGB-Multicolor mit sanft fließendem Lichtwechsel erhältlich.

ca. 6 Lumen, warmweiß 2500 Kelvin

LED Deco Golf Ball

	015-357 LED: 8, 12V AC/DC
	015-359 LED: 8, 12V AC/DC

12 V, 0,5 W, 0,5 VA



Optimiert: Mehr Leuchteffekt speziell für die String Lite® 20. Die Kugelbirnenform des Deco Golf Balls E14/12V kommt den marktüblichen E14 Kugel Glühbirnen recht nahe. Die schwarze Zwischenfassung ist auf marktübliche schwarze Fassungen optimal abgestimmt. Dem Betrachter fällt somit in erster Linie die warmweiße Lichtfarbe ins Auge.

Konfiguration: Erhältlich in warmweißer Lichtfarbe sowie mit mattem oder klarem Polycarbonatgehäuse. Bestens geeignet für den Innen- und Außenbereich.

ACHTUNG BEI AUSSENANWENDUNG: Verwenden Sie unbedingt eine passende Fassung samt Silikondichtring.

ca. 22 Lumen, warmweiß 2500 Kelvin

MK ILLUMINATION
PRODUCTS

PURE LIGHT



STOCK resort, Finkenberg – Austria



Pure Light

Designorientiert. Klar. Edel.

Für all jene, die sich einen etwas reduzierteren Lichterglanz wünschen, haben wir unter der Produktkategorie „Pure Light“ ebenfalls die richtigen Produkte in unserem Portfolio: So hat beispielsweise der Kronux Lichtstrang die Anmutung einer geometrischen Form – als Lichteffect an der Fassade wirkt er jedoch fast spielerisch. Die Wirkung unseres „puren“ Lichteffectes reicht je nach Anordnung von homogen bis hin zu skulptural.

PURE LIGHT

Strip Lite Rope Light

MK ILLUMINATION
PRODUCTS

Rope Light Outdoor 230V

Dieser biegsame PVC-Schlauch, mit den nacheinander eingegossenen LED-Lichtpunkten, ist in verschiedenen Farben erhältlich. Alle Rope Light Outdoor 230V sind untereinander koppel- sowie erweiterbar und entsprechen der Schutzart IP67. Leicht und sicher zu installieren auf Fassaden, Dächern und Konturen sowie bei indirekter Beleuchtung.

Rope Light Outdoor 36V; Strip Lite Outdoor 36V

Die beiden Produkte, mit ihrer biegsamen PVC-Bauform und den nacheinander eingegossenen LED-Lichtpunkten, sind in verschiedenen Farben erhältlich.

Die Produkte sind ausschließlich untereinander koppel- sowie erweiterbar. Durch die Schutzkleinspannung (SELV) eignen sie sich besonders gut für Dekorationen und Beleuchtungen im Handbereich sowie überall dort, wo Niederspannung vorgeschrieben wird.

**Wichtig: Vergessen Sie nie die Anschlüsse
und Endkappen zu verkleben!**

Vergewissern Sie sich auch bei der Installationen, dass keine mechanischen Spannungen oder Längsausdehnungen auf die Produkte einwirken!

Achtung: nur für saisonale Dekoration!



i



- // QuickFix™ Outdoor+ kompatibel
- // kein Power Supply notwendig
- // koppel- und erweiterbar
- // Segmente austauschbar



- // QuickFix™ Low Voltage+ kompatibel
- // Power Supply erforderlich
- // koppel- und erweiterbar
- // Segmente austauschbar



PURE LIGHT

Showroom MK Illumination

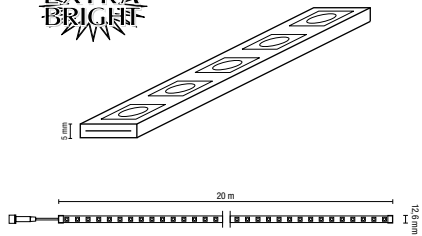

Strip Lite[®]

40 – 20 m

Lampen pro Segment: 8
 Länge pro Segment: 0.20 m 2 U
 Watt/Segment: 1.62 W 1.8 °C
 36 V, 162 W, LED: 800
 ca. 620 Lumen / m



QuickFix™ Low Voltage+ PVC 36 V

LED 245-019

LED 245-020

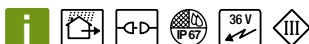

- // Power Supply erforderlich
- // 40 LEDs pro Meter
- // Länge pro Segment: 0,2 m
- // hohe Leuchtkraft



40 High
Brightness
SMD LEDs
620 Lumen/m
120°

ACCESSORIES

QuickFix™ Strip Lite Adapter

001-153

Adapter: QuickFix™ Low Voltage an Strip Lite
inkl. Endkappe, Lösungsmittelkleber, Fixierung und 2
Klebe-Schrumpfschläuchen

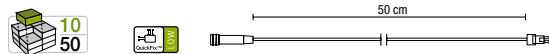

Strip Lite Extension to QuickFix™

001-154

Adapter: Strip Lite an QuickFix™ Low Voltage
inkl. Endkappe, Lösungsmittelkleber, Fixierung und 2
Klebe-Schrumpfschläuchen

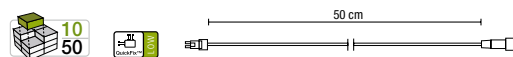

Strip Lite Splice Connect

244-037



244-255



Adapter: Strip Lite an Strip Lite
mit Endkappe, Lösungsmittelkleber,
Einspeisepin und 2 Schrumpfschläuchen



Strip Lite Track Alu

244-035

Befestigungsschiene aus ALU
mit vorgebohrten Löchern
Länge: 1 m



LED Power Supply

► Siehe Seite 135

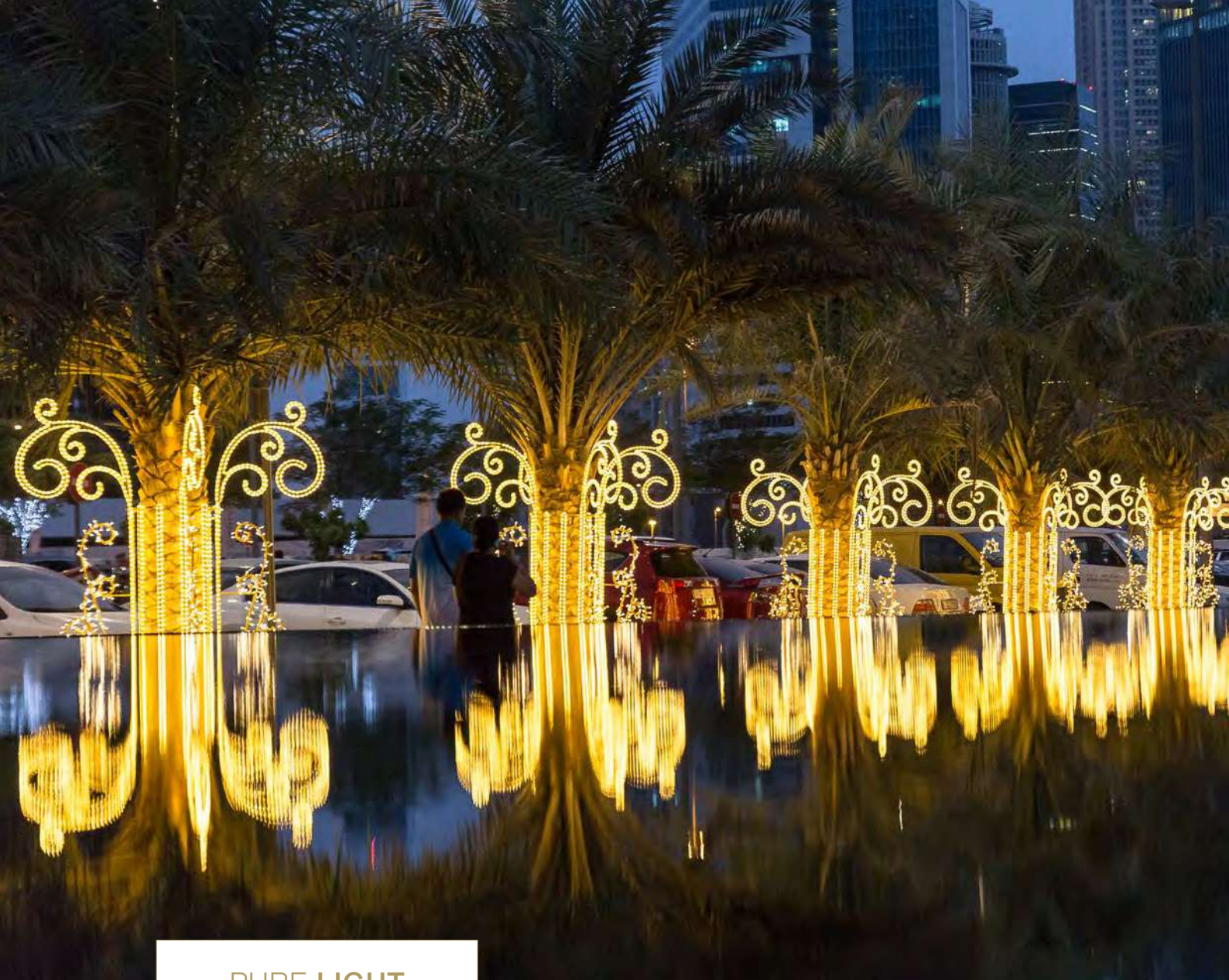

PURE LIGHT

Dubai – Arab Emirates

Rope Light®

30 – 45 m

Ø 13mm

max. Länge: 90m - 2 Rollen

Lampen pro Segment: 30

Länge pro Segment: 1.00 m 22 U

Watt/Segment: 3.5 W 1.8 °C

220-240 V, 157.5 W, LED: 1350



QuickFix™ Outdoor+ PVC 230 V

	248-200
	248-201
	248-202
	248-203
	248-204
	248-205

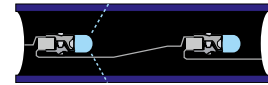

diffuse Lichtwirkung (360°)
Diodenabstand: 3,3 cm

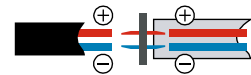

Anschluss LED Lichtschlauch
Überprüfen Sie vor Inbetriebnahme
die Ausrichtung der Anschlusspins.

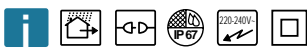

// 30 LEDs pro Meter
// Länge pro Segment: 1 m
// 360° optimale Lichtstreuung

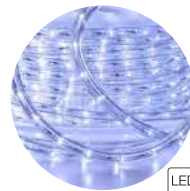

Transparent PVC
(LED: weiß)



Grün transparent PVC
(LED: grün)

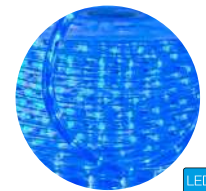

Blau transparent PVC
(LED: blau)



Rot transparent PVC
(LED: rot)

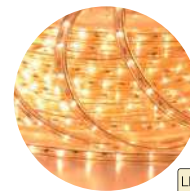

Transparent PVC
(LED: warmweiß)



Amber transparent PVC
(LED: amber)

ACCESSORIES



LED QuickFix™ Main Connector

	EU	UK	CH	AU
	001-011	001-013	001-015	001-017
	001-012	001-014	001-016	001-018

Anschluss: Zuleitung an LED QuickFix™
mit Gleichrichter,
max. Belastbarkeit: 480 W (220C)





PURE LIGHT

Swarovski, Wattens – Austria

Rope Light®

36 – 45 m

Ø 13mm
max. Länge: 90m - 2 Rollen
Lampen pro Segment: 54
Länge pro Segment: 1.50 m
Watt/Segment: 3.5 W
220-240 V, 105 W, LED: 1620



Rope Light®

36 – 44 m

Ø 13mm
max. Länge: 88m - 2 Rollen
Lampen pro Segment: 72
Länge pro Segment: 2.00 m
Watt/Segment: 3.5 W
220-240 V, 77 W, LED: 1584





QuickFix™ Outdoor+ PVC 230 V

Rope Light 36 – 45 m

LED 248-206

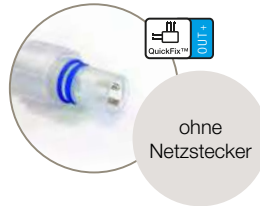

punktgenaue Lichtwirkung
Diodenabstand: 2,77 cm

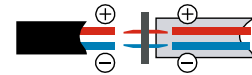

Anschluss LED Lichtschlauch
Überprüfen Sie vor Inbetriebnahme
die Ausrichtung der Anschlusspins.

Rope Light 36 – 44 m

LED 248-208

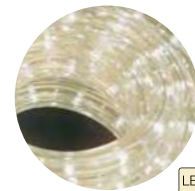

Transparent PVC

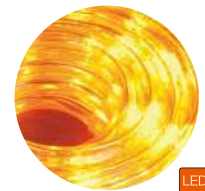

Transparent PVC

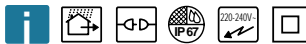

- // 36 LEDs pro Meter
- // Länge pro Segment: 1,5 m und 2 m
- // hohe Leuchtkraft

ACCESSORIES



LED QuickFix™ Main Connector

	EU	UK	CH	AU
	001-011	001-013	001-015	001-017
	001-012	001-014	001-016	001-018

Anschluss: Zuleitung an LED QuickFix™
mit Gleichrichter,
max. Belastbarkeit: 480 W (220C)



Eger – Hungary



PURE LIGHT

Hotel Stock, Finkenberg – Austria

Rope Light®

30 – 20 m

Ø 13mm
max. Länge: 60 m - 3 Rollen
Lampen pro Segment: 10
Länge pro Segment: 0.33 m

1.1	U
-----	---

Watt/Segment: 0.5 W

0.6	°C
-----	----

36 V, 30 W, LED: 600



QuickFix™ Low Voltage+ PVC 36 V

LED	245-030
LED	245-031
LED	245-032
LED	245-033
LED	245-034
LED	245-035
LED	245-036
LED	245-037



// Power Supply erforderlich
 // 30 LEDs pro Meter
 // Länge pro Segment: 0,33 m
 // 360° optimale Lichtsteuerung

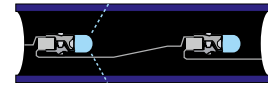

diffuse Lichtwirkung (360°)
 Diodenabstand: 3,3 cm

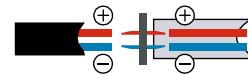

Anschluss LED Lichtschlauch
 Überprüfen Sie vor Inbetriebnahme
 die Ausrichtung der Anschlusspins.



Transparent PVC



Grün transparent PVC

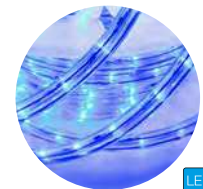

Blau transparent PVC



Rot transparent PVC

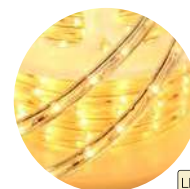

Transparent PVC



Amber transparent PVC

ACCESSORIES



QuickFix™ Dimmer

202-001

QuickFix™ Low Voltage kompatibel
 max. Belastbarkeit: 200 W (220C)



LED Power Supply

► Siehe Seite 135



Pink transparent PVC



Violett transparent PVC



PURE LIGHT

Dubai - UAE

High Linear[®]





QuickFix™ Low Voltage+

	HighLinear 54		HighLinear 108		HighLinear 163	
	60 cm		120 cm		180 cm	
	12 W/m	5 W/m	12 W/m	5 W/m	12 W/m	5 W/m
Color Kelvin						
LED 2700 K	010-101	010-107	010-102	010-108	010-103	010-109
LED 4000 K	010-104	010-110	010-105	010-111	010-106	010-112
Lumen / m	510 lm/m	200 lm/m	510 lm/m	200 lm/m	510 lm/m	200 lm/m
QFC	8	3.5	16	7	24	10
QFU	6	6	12	12	18	18
Watt	7,2 W	3 W	14,4 W	6 W	21,6 W	9 W



// koppel- und erweiterbar

// Homogene Lichtfläche

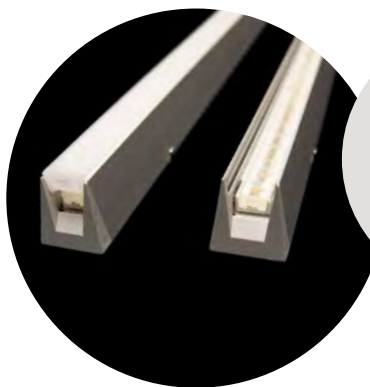

Auf Anfrage auch RGB-Lichtlösungen erhältlich.

ACCESSORIES

QuickFix™ HighLinear Adapter

002-149

Adapter: QuickFix™ Low Voltage+ an HighLinear

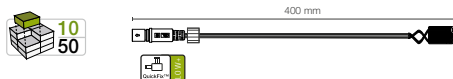

HighLinear QuickFix™ Adapter

002-150

Adapter: HighLinear an QuickFix™ Low Voltage+ inkl. Endkappe

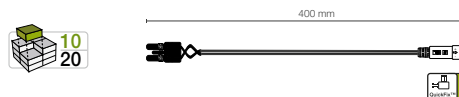

LED Power Supply

► Siehe Seite 135



PURE LIGHT

MK Illumination

Tree String Lite®

20 m

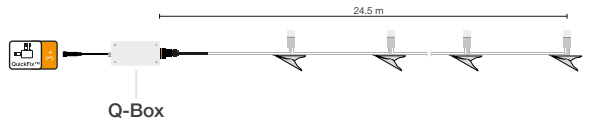

Länge: 20 m
Abstand zwischen LED: 1.5 m
220-240 V, 17 W, LED: 14
1.90 kg, 14 High Power LEDs
350mA
inkl. Q-Box: 0.6 kg



QuickFix™ Outdoor+
Rubber 230 V | 17 W



008-500



- // QuickFix™ 3+ kompatibel
- // 14 High Power LEDs
- // Klemme für einfache Montage
- // hohe Leuchtkraft

Eine Lichterkette umfasst 14 Power LEDs und hat einen Gesamtleistungsverbrauch von 17 Watt, 350mA. Der Abstand zwischen den LED's beträgt 1,5 m.

Jeder LED Körper ist mit einer eigenen Klemme versehen und erlaubt eine ebenso schnelle wie einfache Montage. Mit den Lichterketten lassen sich höchst beeindruckende Lichteffekte gestalten – gleichzeitig erzeugen sie stets eine behagliche Stimmung und wohlige Atmosphäre.

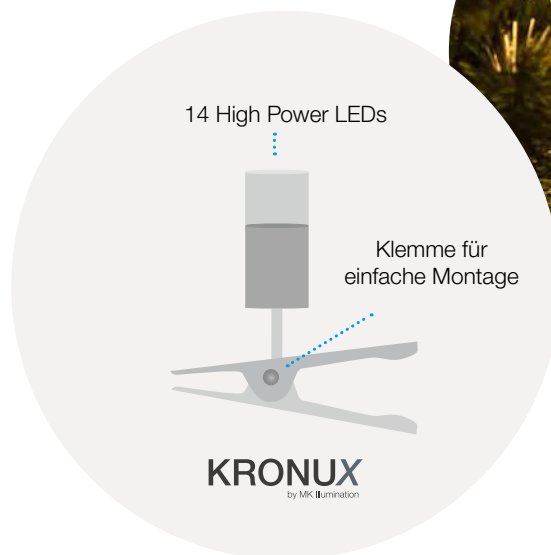

ACCESSORIES

QuickFix™ 3+ Main Connector

	EU	UK	CH	AU
	003-001	003-003	003-005	003-007
	003-002	003-004	003-006	003-008

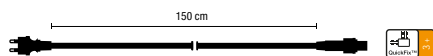

Anschluss: Zuleitung an QuickFix™
max. Belastbarkeit: 1800 W (820C)



siehe Seite 124



PURE LIGHT

Jelmoli Zürich – Switzerland

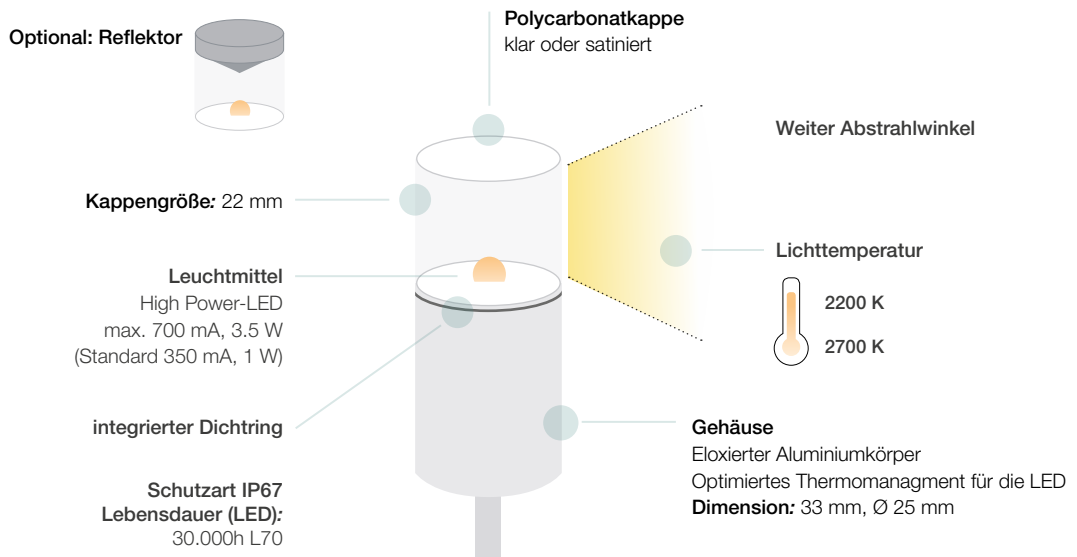

Der KRONUX Lichtstrang hat die Anmutung einer geometrischen Form – als Lichteffekt an der Fassade wirkt er jedoch fast spielerisch.

Je nach Örtlichkeit oder Architektur werden Lichtpunkte mit unterschiedlichem Abstand gesetzt, denn so verändert sich die Wirkung des Lichteffekts – von homogen bis skulptural.

Das Geheimnis der Kronux-Leuchten liegt in der nuancierten Abstimmung von Gehäuse, Kappe und LED-Licht.

Die Kappen werden je nach Beschaffenheit der Fassade ausgewählt und eingesetzt. Je nach Form bzw. Eigenschaft von Gehäuse, Kappe und LED-Licht erzeugen sie ihre individuelle Abstrahl-Charakteristik:

- Klar – brillant, funkelnd
- satiniert – homogen, ruhig
- brillant im Seitenbereich (Reflektor) – ideal für Motive

Durch eine versetzte Ausrichtung der Lichtpunkte von jeweils ca. 90° zueinander, wirken diese unterschiedlich groß und dadurch auch sehr natürlich im Effekt. An Inox Seilen (Edelstahl) werden sie von Hand befestigt und sind so höchst individuell je nach Anforderung gestaltbar.

Die Montage der Lichtstränge an Fassaden erfolgt über ein Trägersystem mit je einer Fixierung an den Enden.

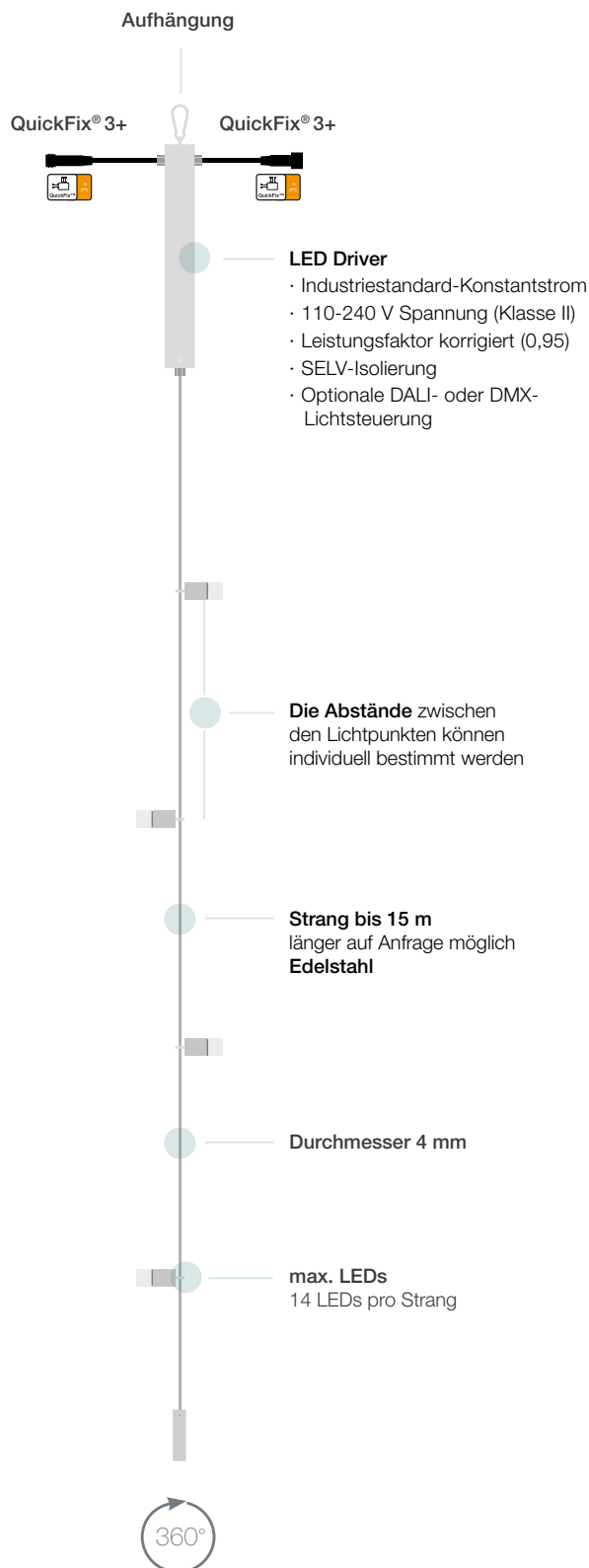

PURE LIGHT *accessories*

ROPE LIGHT 230 V

QuickFix™ Rope Light Adapter

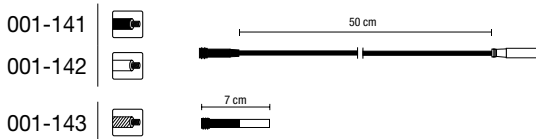

Adapter: QuickFix™ an Rope Light
mit Endkappe, Lösungsmittelkleber, Einspeisepin und 2 Schrumpfschläuchen
max. Belastbarkeit: 740 W



siehe Seite 124

Rope Light Extension to QuickFix™

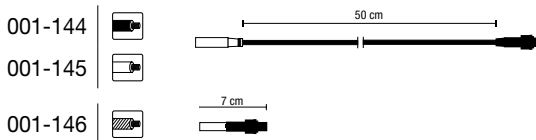

Adapter: Rope Light an QuickFix™
mit Endkappe, Lösungsmittelkleber, Einspeisepin und 2 Schrumpfschläuchen
max. Belastbarkeit: 740 W



siehe Seite 124

LED Main Connection Set



- 001-021
- 001-023
- 001-025

Anschluss-Set für LED Lichtschlauch

inkl. AC/DC-Wandler, mit Endkappe, Lösungsmittelkleber, Einspeisepin und 2 Schrumpfschläuchen
max. Belastbarkeit: 480 W



ROPE LIGHT 36 V

QuickFix™ Rope Light 36V Adapter

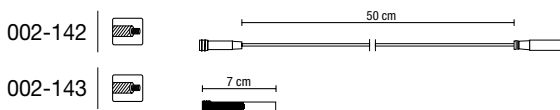

Adapter: QuickFix™ an Rope Light 36V
mit Endkappe, Lösungsmittelkleber, Einspeisepin und 2 Schrumpfschläuchen



siehe Seite 132

Rope Light 36V Extension to QuickFix™

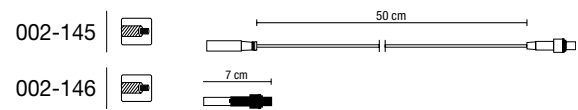

Adapter: Rope Light 36V an QuickFix™
mit Endkappe, Lösungsmittelkleber, Einspeisepin und 2 Schrumpfschläuchen



siehe Seite 132

Rope Light Track Alu

244-253
Befestigungsschiene aus ALU mit vorgebohrten Löchern
Länge: 1.5 m



Rope Light Track PET

244-259
Befestigungsschiene aus PET
Länge: 1.5 m



Transparent

Endcaps

244-218
10 Endkappen, 10 Schrumpfschläuche



Feeding Elements

244-219
Verbindet Main Connector mit Ropelight
Verpackungsinhalt: 10



Endcap Set

244-023
1 Kunststoffkleber,
3 Schrumpfschläuche, 3 Endkappen



Splice Connect

244-217
Verbindet Ropelight mit Ropelight
Verpackungsinhalt:10



Connector Set

244-002
2 Verbindungskupplungen,
2 Verbindungspins,
1 Kunststoffkleber,
4 Schrumpfschläuche



T-Connector Set

244-003
1 T-Verbinder, 3 Einspeisepins,
2 Endkappen,
1 Kunststoffkleber,
5 Schrumpfschläuche



Glue

244-006
1 Kunststoffkleber



Mounting Clip

244-014
Verpackungsinhalt:100

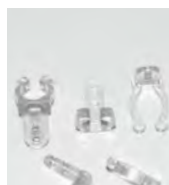

Crocodile Clip

244-005
Verpackungsinhalt:25



MK ILLUMINATION
PRODUCTS

ANIMATED LIGHT



Metropolis, Moscow – Russia



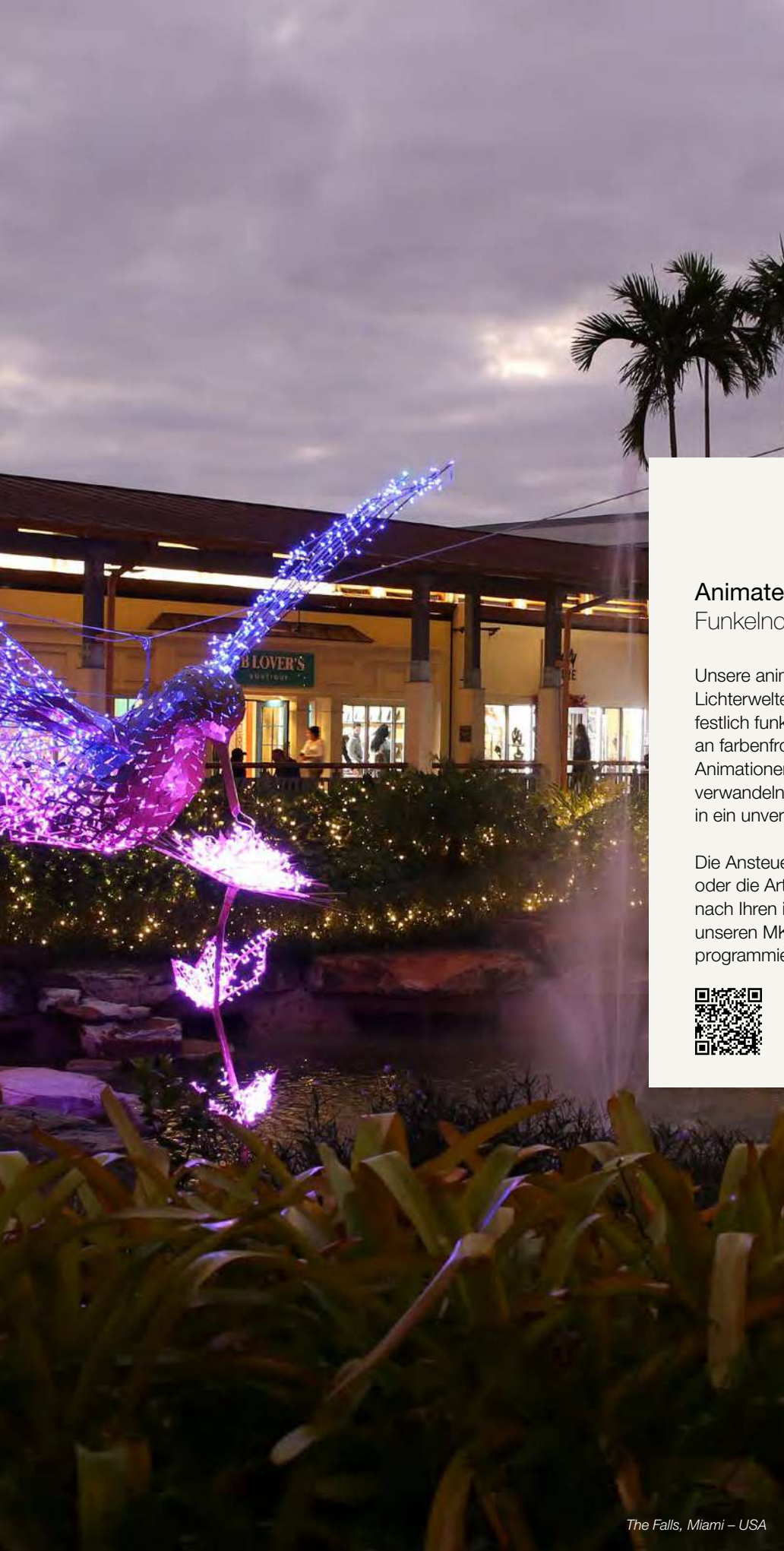

Animated Light

Funkelnd. Lebendig. Freudvoll.

Unsere animierten Lichtprodukte hauchen Licherwelten Leben ein und sorgen für ein festlich funkelndes Ambiente. Eine Vielzahl an farbenfrohen Lichtpunkten, individuellen Animationen und lebendigen Effekten verwandeln jeden Ort, ob groß oder klein, in ein unverwechselbares Licherlebnis.

Die Ansteuerung der Lichtpunkte (Pixel), oder die Art des Farbenspiels, kann ganz nach Ihren individuellen Wünschen von unseren MK Technik-Experten programmiert werden.



ANIMATED LIGHT

i-String Lite



i-String Lite®

Die logische Evolution der
String Lite® Lichterketten

Herzstücke der koppelbaren Lichterkette sind die intelligenten LED Lichtpunkte in warmweiß, brillantweiß und für bunte Farbeffekte auch in RGB- (Rot, Grün, Blau). Optisch nur durch eine kleine Steuerplatine an der LED unterscheidbar, lassen sich alle Lichterketten individuell anstecken und alle Lichtpunkte dann einzeln und individuell ansprechen. Die einzelnen i-String Lite® Lichterketten können einfach zu einem Netzwerk zusammengesteckt werden. So entstehen besonders lebendige und optisch wirksame Animationen und Effekte bzw. interaktive Muster sowie Lauftexte. Separate Datenleitungen gibt es nicht, die Kommunikation erfolgt über das zweipolige QuickFix™ Kabel mittels MK Power Line Communication (MK PLC).

Alle LEDs der i-String Lite® werden in Echtzeit angesteuert. Ideal um beispielsweise interaktive und zielgruppengerechte Werbebotschaften einzublenden. Durch die individuelle Ansteuerung der einzelnen LEDs funktioniert die i-String Lite® Lichterkette auch bei 3D-Motiven hervorragend.

MK ILLUMINATION
PRODUCTS

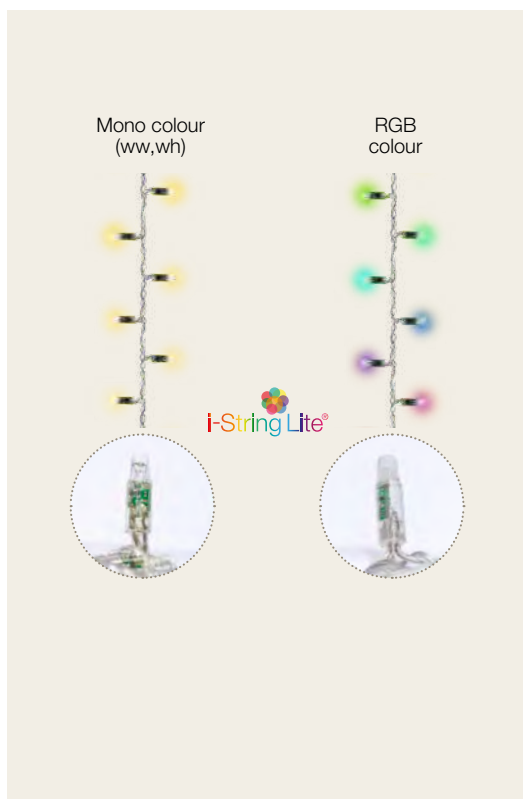

Das i-String Lite® System baut auf die bestehende QuickFix™ Low Voltage+ Familie (36V) auf und ist dadurch auch mit den anderen 36V Lichtprodukten kompatibel. Maximale Flexibilität ist damit garantiert.

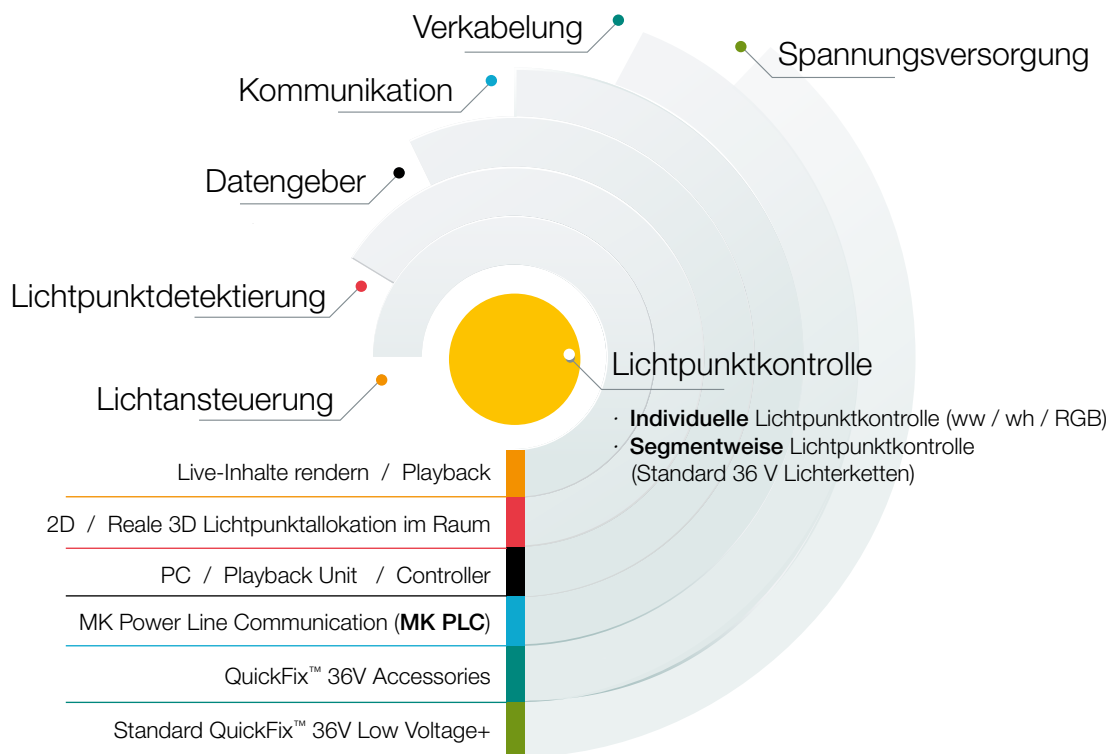

Möglichkeiten der Lichtpunktkontrolle

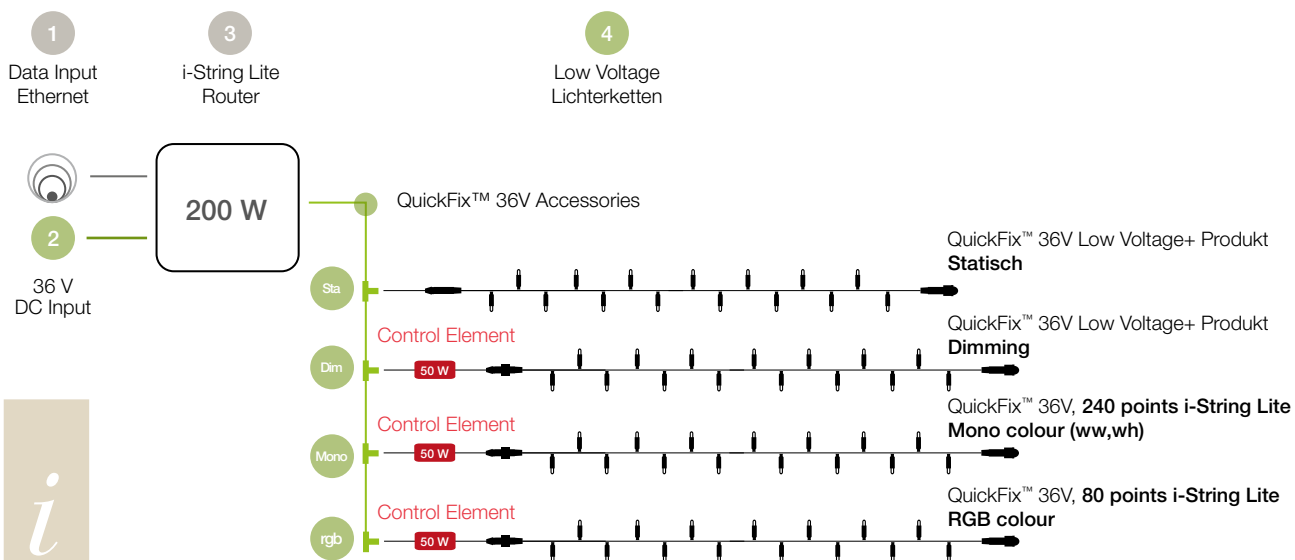

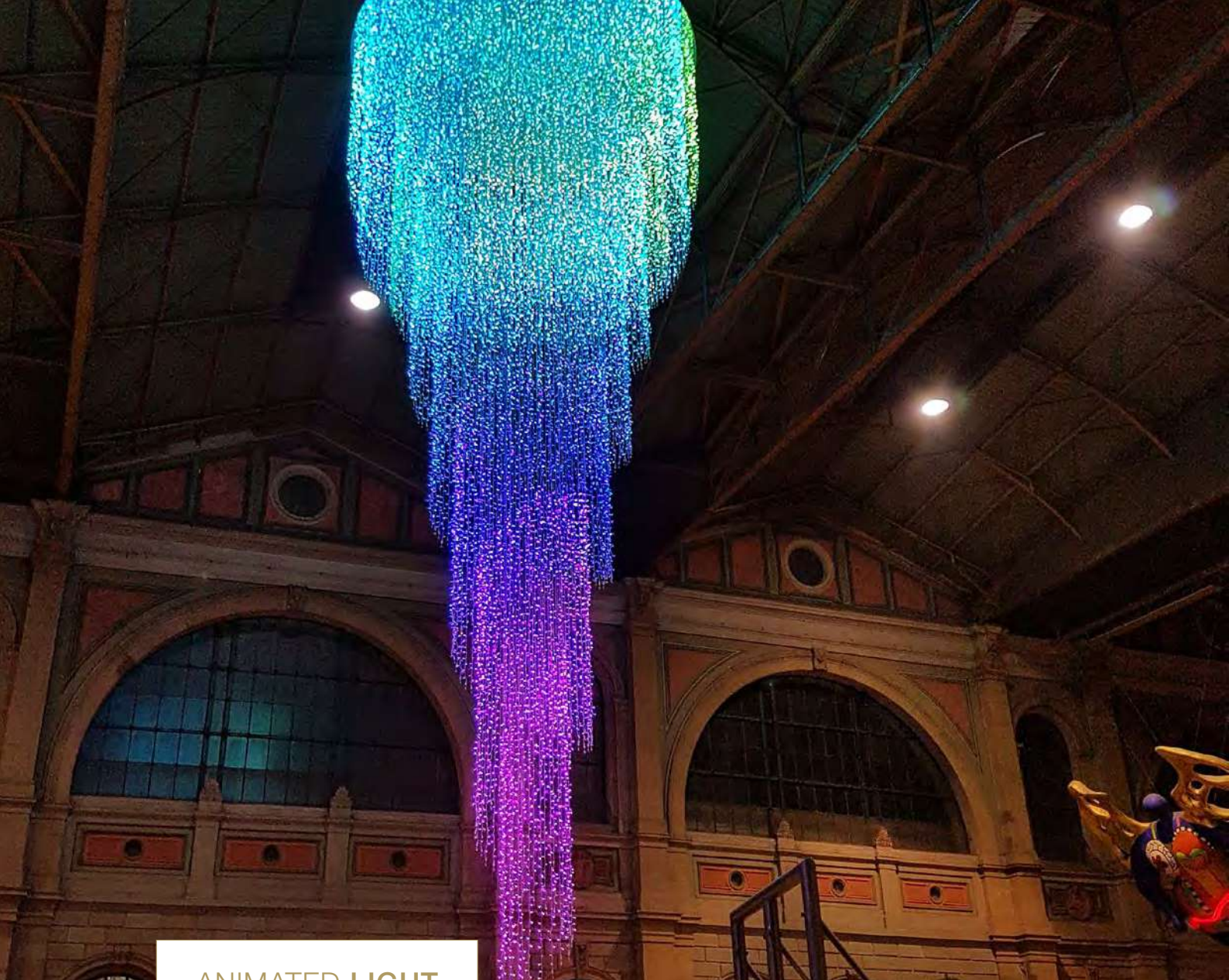

ANIMATED LIGHT

Zurich, Mainstation – Switzerland

i-String Lite®

40 – 4 m

Länge: 4 m
Anzahl der Segmente: 1
Lampen pro Segment: 40
Länge pro Segment: 4.00 m
36 V, LED: 40

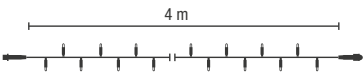

i-String Lite®

80 – 4 m

Länge: 4 m
Anzahl der Segmente: 1
Lampen pro Segment: 80
Länge pro Segment: 4.00 m
36 V, LED: 80

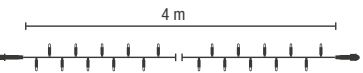



QuickFix™ Low Voltage+
PVC & Rubber 36 V

36V LED i-String Lite® 40

Auf Anfrage!

Auf Anfrage!

Auf Anfrage!

NEW! Auf Anfrage!



QuickFix™ Low Voltage+
PVC & Rubber 36 V

36V LED i-String Lite® 80

Auf Anfrage!

Auf Anfrage!

Auf Anfrage!

NEW! Auf Anfrage!

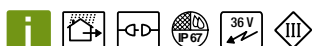

- // individuelle Lichtpunktsteuerung
- // i-String Lite® Steuerung erforderlich
- // MK Power Line Communication
- // Power Supply erforderlich
- // transparentes PVC Kabel
- // koppel- und erweiterbar
- // schwarzes Gummikabel
- // Segmente austauschbar

ACCESSORIES



QuickFix™ Low Voltage+
Power Supply

▶ siehe Seite 135





ANIMATED LIGHT

Metropolis, Moscow – Russia



Pre-Programmed ANIMATED LIGHT

Pre-Programmed ermöglicht eine Veränderung vorgefertigter Animationen wie beispielsweise den Farbwechsel bei der Edison RGB, oder die Geschwindigkeit einer Animation beim IceDrop. Benutzerfreundliche und einfache Konfigurationen. Die Effekte bleiben auch im stromlosen Zustand am Controller gespeichert. Der passende vorprogrammierte Controller ist in manchen Produkten bereits verbaut.

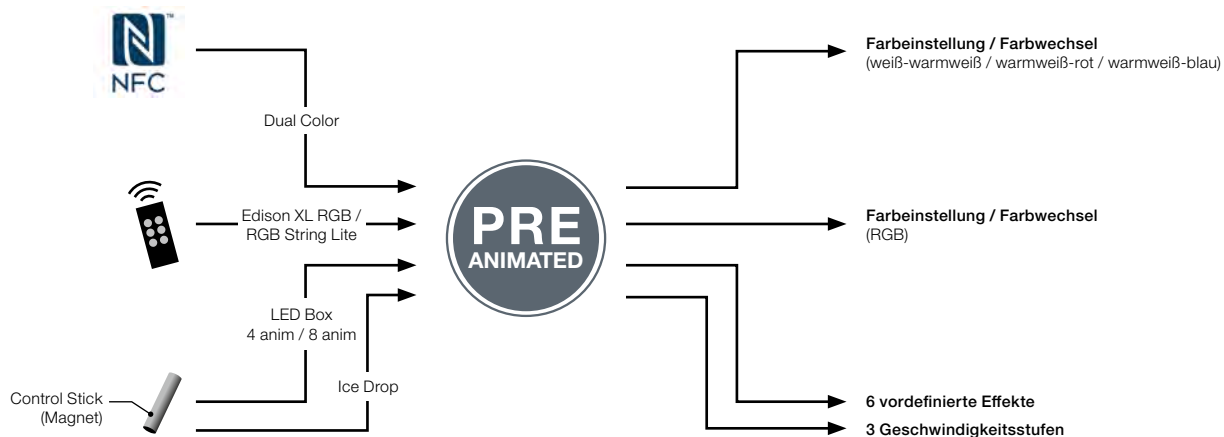



DMX

ANIMATED LIGHT

DMX ist ein Steuerungssignal, durch welches man 512 einzelne Kanäle ansteuern kann. Jede Lichtquelle benötigt eine gewisse Anzahl an Kanälen, um die Helligkeit und / oder Lichtfarbe einzustellen. Die Lichtquellen werden in Reihe hintereinander mit dem DMX-Kabel verbunden, wobei der Ein- und Ausgang jeweils nacheinander folgt.

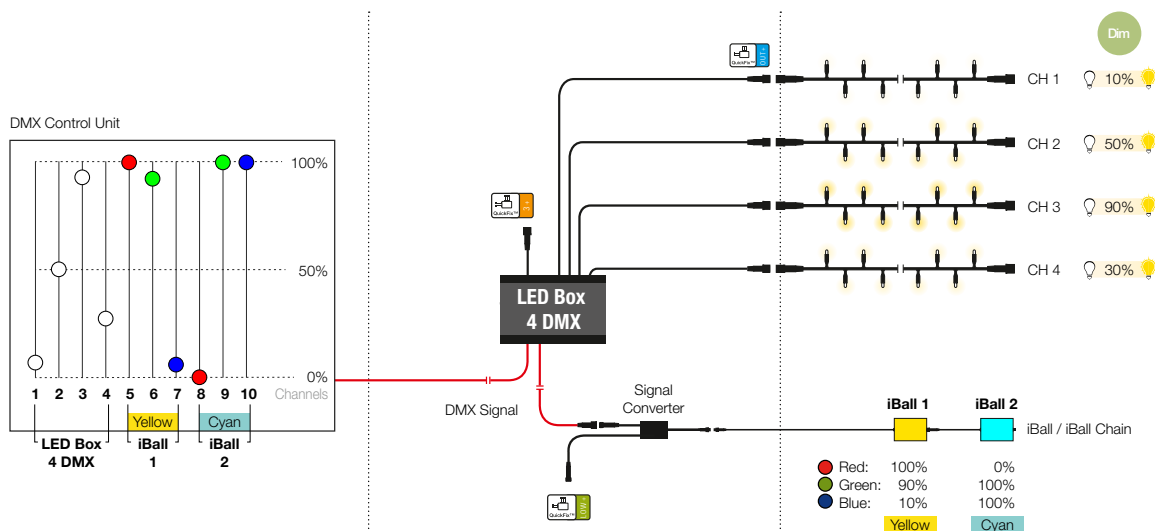

Die **DMX Control Unit** (Zentrale Steuereinheit) ist der Taktgeber und das Gehirn jeder Animation.

Wie in unserer Grafik dargestellt, kann man durch sie die zeitabhängige Veränderung der einzelnen Regler die Helligkeit und/ oder Farbe des Lichtprodukts individuell variieren.

Der „MK-Showtime“ verfügt über eine DMX Hardware und Software. Über die Software lassen sich einfache Animationen erstellen und im Anschluss auf der Hardware speichern.

Die Animation passiert, durch die Veränderung der Regler innerhalb eines gewissen Zeitraums. Die entsprechende Steuereinheit ist mittels eines fünfpoligen DMX Kabels mit den Controllern verbunden.

Der Controller ist notwendig, um ein DMX-Signal auf ein für ein MK-Lichtprodukt verständliches Signal zu konvertieren.

Für jedes animierte Lichtprodukt gibt es entsprechende Controller, die immer mit DMX gekennzeichnet sind.

Bei den Controllern lässt sich die Startadresse entweder individuell einstellen, so beispielsweise bei unser DualColor, der Animationsbox sowie der Edison RGB, oder sie wird verkabelungsabhängig vergeben wie bei unseren i-Balls.

Das **Lichtprodukt** gibt die aktuellen Regler-Einstellungen der zentralen Steuereinheit wieder.

Eine Animationsbox 4DMX besitzt jeweils vier Ausgänge, an welchen unsere QuickFix™ Outdoor+ Produkte angeschlossen werden. Jeder Ausgang am Lichtprodukt kann separat und individuell gedimmt werden. (z.B. Regler 1 am Ausgang 1, Regler 2 am Ausgang 2)

Bei RGB Produkten benötigt man drei Regler pro Lichtpunkt. Jeder Regler dimmt eine der drei Primär-Farben rot, grün und blau. Mittels eines diffusen Lichtkörpers entsteht aus der Mischung der drei Primärfarben eine Mischfarbe, wie z.B. gelb oder cyan.



ANIMATED LIGHT

Haldenzauber Hückelhoven – Germany



DMX ANIMATED LIGHT



Mit der QuickFix™ LED-Box 4dmx oder QuickFix™ LED-Box 8dmx können die normalerweise statisch leuchtenden StringLite Lichterketten (QuickFix™ Outdoor+) pulsieren, gedimmt werden oder sogar in eine musikalische "Sound to Light" Animation verwandelt werden.

Diese Effekte generiert man durch eine Standard DMX Steuerung, wie zum Beispiel unserer "MK-Showtime Pro" oder "MK-Showtime Easy". Jeder Ausgang ist hier über das DMX512-A Protokoll einzeln ansteuerbar.

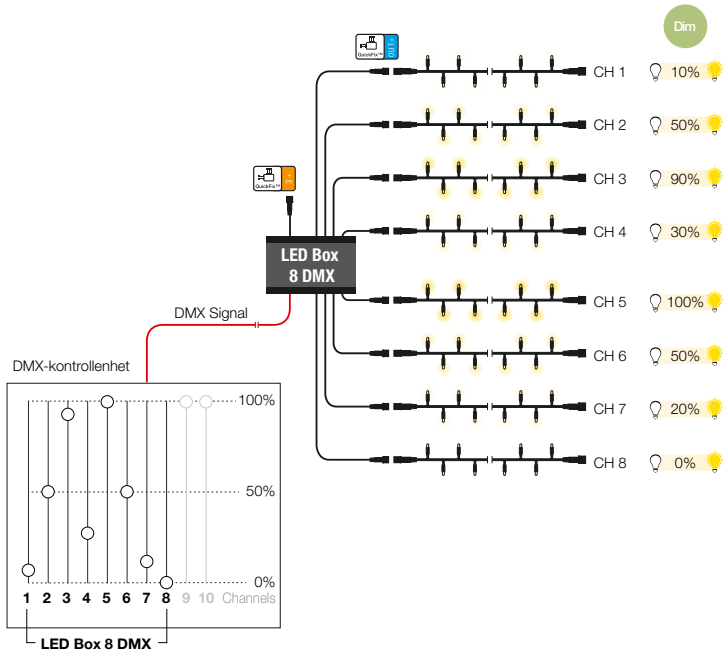

MK Showtime Pro 1 **205-001**

512 Channel DMX Interface
2 DMX Ausgänge
Netzwerkanschluss: 1 x RJ45
Trigger: Uhr/Kalender, physisch
Smartphone/Tablet Steuerung
90 x 40 x 75 mm, 0.12 kg

// nur für den Innengebrauch!



MK Showtime Easy 1 **205-002**

512 Channel DMX Interface
1 DMX Ausgang
Trigger: physisch
90 x 40 x 75 mm, 0.12 kg

// nur für den Innengebrauch!



MK Showtime Power Supply 1 **206-001**

Eingang: 100-240V 50/60 Hz
Ausgang: 5V DC 1A
0.14 kg

// nur für den Innengebrauch!

DMX ANIMATED LIGHT

QuickFix™ LED Box 4dmx

4-Kanal DMX Steuerbox zum Anschliessen von QuickFix™ LED Produkten
 IP 65 mit eingebauter Überlastsicherung und aktiver PFC (PF 0,95)
 Zuleitung: QuickFix™ 3+, 220-240 V AC
 Zuleitungslänge: 0,5m
 Summe aller Ausgänge darf 800W (360C) nicht überschreiten
 max. Belastbarkeit pro Ausgang: 200W (90C)
 4 QuickFix™ Outdoor Ausgänge
 Überlast- und Kurzschlusschutz

Adressierung über Dipschalter, kompatibel mit USITT DMX512-A Protokoll
 33 x 22 x 9 cm, 3,50 kg, T6,3A/250V

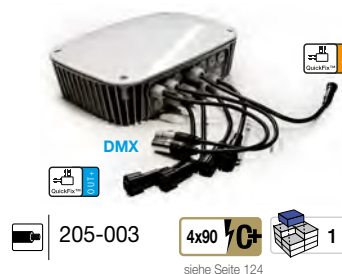

QuickFix™ LED Box 8dmx

8-Kanal DMX Steuerbox zum Anschliessen von QuickFix™ LED Produkten
 IP 65 mit eingebauter Überlastsicherung und aktiver PFC (PF 0,95)
 Zuleitung: QuickFix™ 3+, 220-240 V AC
 Zuleitungslänge: 0,5m
 Summe aller Ausgänge darf 800W (360C) nicht überschreiten
 max. Belastbarkeit pro Ausgang: 100W (45C)
 8 QuickFix™ Outdoor Ausgänge
 Überlast- und Kurzschlusschutz

Adressierung über Dipschalter, kompatibel mit USITT DMX512-A Protokoll
 33 x 22 x 9 cm, 3,50 kg, T6,3A/250V



ACCESSORIES



QuickFix™ Main Connector

	EU	UK	CH	AU
	003-001	003-003	003-005	003-007
	003-002	003-004	003-006	003-008

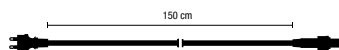

Anschluss: Zuleitung an QuickFix™
 max. Belastbarkeit: 1800 W (820C)

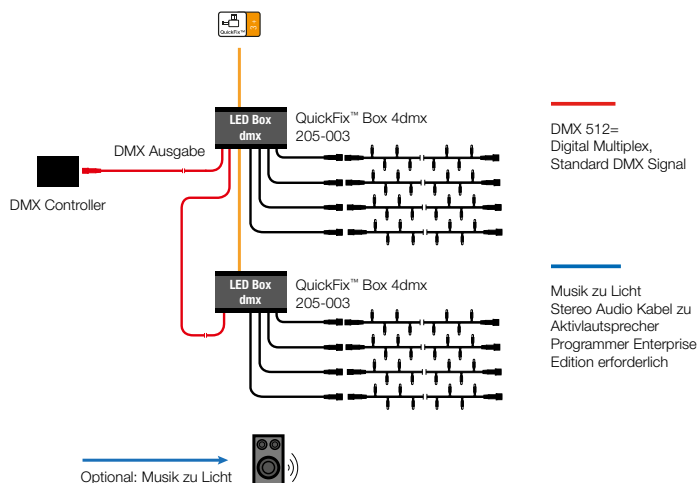



Pre-Programmed ANIMATED LIGHT



QuickFix™ LED-Box 4anim Preprogrammed

Vorprogrammierte Steuerbox zum Anschließen von QuickFix™ LED Produkten
 IP 65 mit eingebauter Überlastsicherung und aktiver PFC (PF 0,95)
 Zuleitung: QuickFix™ 3+, 220-240 V AC
 Zuleitungslänge: 0,5m
 Summe aller Ausgänge darf 800W (360C) nicht überschreiten
 max. Belastbarkeit pro Ausgang: 200W (90C)
 4 QuickFix™ Outdoor Ausgänge
 Überlast- und Kurzschlusschutz

33 x 22 x 9 cm, 3.50 kg, T6,3A/250V

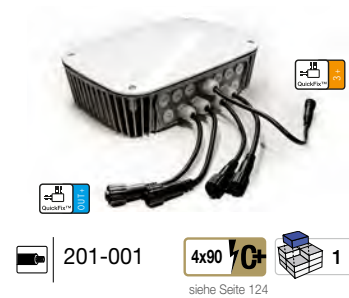

QuickFix™ LED-Box 8anim Preprogrammed

Vorprogrammierte Steuerbox zum Anschließen von QuickFix™ LED Produkten
 IP 65 mit eingebauter Überlastsicherung und aktiver PFC (PF 0,95)
 Zuleitung: QuickFix™ 3+, 220-240 V AC
 Zuleitungslänge: 0,5m
 Summe aller Ausgänge darf 800W (360C) nicht überschreiten
 max. Belastbarkeit pro Ausgang: 100W (45C)
 8 QuickFix™ Outdoor Ausgänge
 Überlast- und Kurzschlusschutz

33 x 22 x 9 cm, 3.50 kg, T6,3A/250V



ACCESSORIES



QuickFix™ Main Connector

	EU	UK	CH	AU
	003-001	003-003	003-005	003-007
	003-002	003-004	003-006	003-008

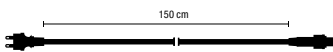

Anschluss: Zuleitung an QuickFix™
 max. Belastbarkeit: 1800 W (820C)



Control Stick (Magnet)
 Ändern Sie den Animationsmodus bzw. die Geschwindigkeit Ihrer Animation, indem Sie mit dem Control Stick die Bedienelemente der Animationsboxen berühren.

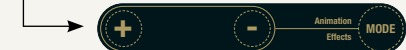



Pre-Programmed ANIMATED LIGHT



Animationsbox Pre-Programmed:

Unsere QuickFix™ LED-Box 4anim Pre-Programmed und die QuickFix™ LED-Box 8anim Pre-Programmed ermöglichen einfache vorprogrammierte Animationen von QuickFix™ Outdoor+ Produkten. Es sind jeweils sechs vorprogrammierte Effekte hinterlegt, die man mit Hilfe des Control Sticks (Magneten) individuell einstellbar sind. Der Animationsmodus, ebenso wie die Abspielgeschwindigkeit können so beliebig verändert werden.

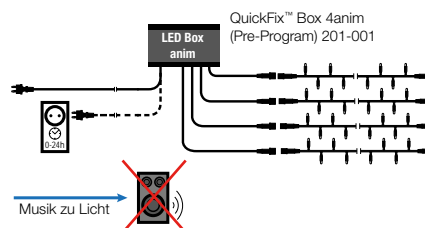

Pre-Programmed Animation Effects

Channels **1** **2** **3** **4**

Blinken

- Alle Kanäle blinken periodisch
- Geschwindigkeit in Stufen regelbar



Dimmen

- Alle Kanäle blenden wiederholt in der gleichen Art von 0% bis 100% Helligkeit ein und aus.
- Geschwindigkeit in Stufen regelbar

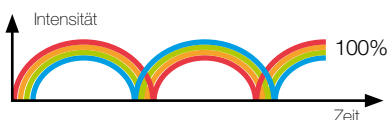

Wellen

- Eine Welle wird durch alle Kanäle durchgeschaltet
- Ein Kanal wird von 0% auf 100% gedimmt, im Übergang überlappen sich die Kanäle, die Kanäle werden chronologisch zeitversetzt einzeln durchgeschaltet
- Geschwindigkeit in Stufen regelbar

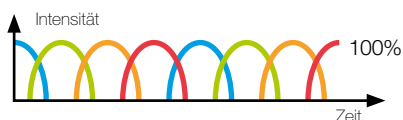

Dauerlicht

- Alle Kanäle werden mit der gleichen Helligkeit angesteuert
- Helligkeit ist einstellbar 0% bis 100%
- Kann so als Dimmer verwendet werden

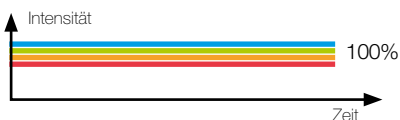

Aufbauend 1

- Alle Kanäle werden chronologisch zeitversetzt eingeschaltet, wobei die eingeschalteten Kanäle an bleiben
- Alle Kanäle werden dann zusammen ausgeschaltet
- Geschwindigkeit in Stufen regelbar

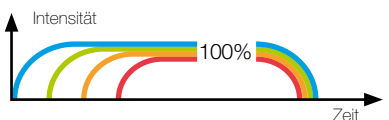

Aufbauend 2

- Alle Kanäle werden chronologisch zeitversetzt eingeschaltet, wobei die eingeschalteten Kanäle an bleiben
- Alle Kanäle werden dann invers chronologisch einzeln zeitversetzt wieder ausgeschaltet
- Geschwindigkeit in Stufen regelbar

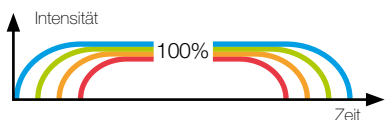



ANIMATED LIGHT



Bremerhaven – Germany

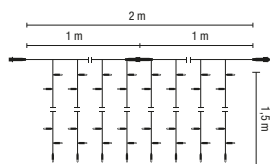
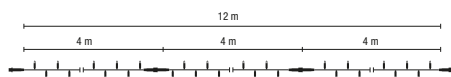

Dual Color

- // Kanalweise Lichtsteuerung
- // Power Supply erforderlich
- // transparentes PVC Kabel
- // koppel- und erweiterbar
- // schwarzes Gummikabel
- // Segmente austauschbar
- // Controller erforderlich



QuickFix™ Low Voltage+ PVC & Rubber 36 V | 4.3 W

36V LED Dual String Lite® 120

	029-660
	029-661
	029-662
	029-663
	029-664

NEW!

Länge: 12 m
Anzahl der Segmente: 3
Lampen pro Segment: 40
Länge pro Segment: 4.00 m
LED: 120



siehe Seite 132

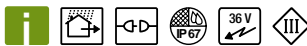

NEW!



QuickFix™ Low Voltage+ PVC 36 V | 7.2 W

36V LED Dual Drape Lite® 200

	029-665
--	---------

Dimension: 2 m x 1.5 m
Anzahl der Stränge: 20
Lampen pro Strang: 10
Länge pro Strang: 1.50 m
LED: 200



siehe Seite 132

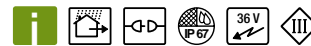

NEW!



QuickFix™ Low Voltage+ PVC 36 V | 30 W

36V LED Dual Rope Light 20 m

	245-039
	245-040

Ø 13 mm
max. Länge: 60 m - 3 Rollen
Lampen pro Segment: 10
Länge pro Segment: 0.33 m **1.1 U**
Watt/Segment: 0.5 W **0.6 kWh**
LED: 600



siehe Seite 132

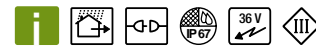

ACCESSORIES

DualColor Polarity Adapter

202-207

max. Belastbarkeit: 200 W (220C), 0.04 kg



siehe Seite 132

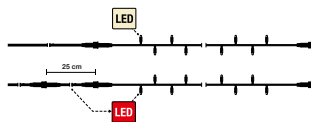

DualColor Polarity Adapter

Der Polarity Adapter ermöglicht es, die Lichtfarbe der Dual String Lite Kette statisch zu wechseln. Der Polarity Adapter ist nur für Dual String Lite Installationen gedacht und ist nicht zwingend notwendig.

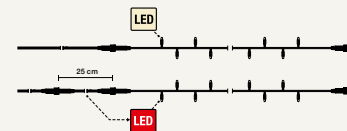

DualColor Polarity Switch

202-206

Farbwechsel durch mechanische Umschaltung
max. Belastbarkeit: 200 W (220C)
65 x 40 x 60 mm, 0.2 kg



siehe Seite 132

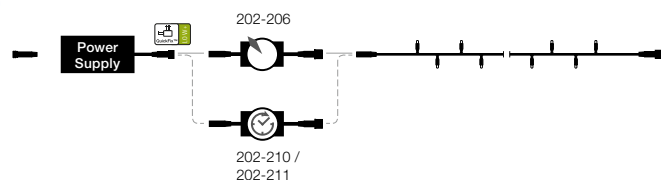
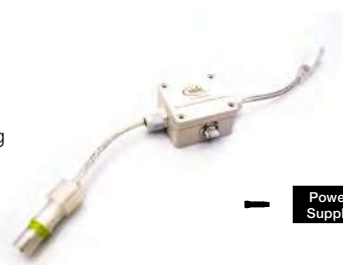
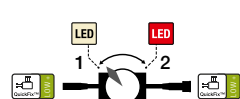



ANIMATED LIGHT



Stuttgart – Germany

NEW

QuickFix™ Low Voltage Controller

Steuerungen der QuickFix™ Low Voltage Controller Serie können Produkte der QuickFix™ Low Voltage Serie und der QuickFix™ Low Voltage Dual Colour Serie regulieren.

Im Falle der statischen Produkte ist es möglich, diese gedimmt oder pulsierend anzusteuern. Bei unseren Dual Colour Produkten kann man diese Effekte auf zwei Farben zuteilen.



ACCESSORIES

QuickFix™ Low Voltage Controller
Pre-Programmed RTC

	202-210
	202-211

max. Belastbarkeit: 200 W (220C)
70 x 28 x 40 mm, 0.18 kg



siehe Seite 132

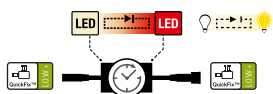

QuickFix™ Low Voltage Controller Pre-Programmed:

Der QuickFix™ Low Voltage Pre-Programmed Controller bietet eine Vielzahl an modifizierbaren, vorprogrammierten Effekten. Diese kann man mit Hilfe eines NFC fähigen Smartphones beliebig anpassen und bei Bedarf für ein bestimmtes Datum und Uhrzeit programmieren, an denen diese Effekte als besonderes Highlight abgespielt werden sollen. Die Echtzeituhr (RTC) wird umweltfreundlich ohne Batterie gespeichert, die stromlose Pufferung reicht für 21 Tage.

Der QuickFix™ Low Voltage Controller ist mit folgenden Power Supplies kompatibel: 35W, 70W, 90W, 120W oder 200W



ACCESSORIES

QuickFix™ Low Voltage Controller
1dmx

202-209
max. Belastbarkeit: 200 W (220C)
70 x 30 x 60 mm, 0.28 kg



siehe Seite 132

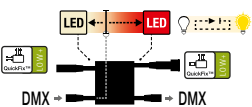

QuickFix™ Low Voltage Controller (1dmx/4dmx)

Mit dem QuickFix™ Low Voltage Controller (1dmx/4dmx) können die normalerweise statisch leuchtenden String Lite oder Dual String Lite Lichterketten (QuickFix™ Low Voltage+) pulsieren, gedimmt, oder sogar in eine klingende "Sound to Light" Animation verwandelt werden.

Diese Effekte sind ganz einfach mit einer Standard DMX Steuerung, wie beispielsweise unserer MK-Showtime Pro oder Easy zu erzielen. Jeder Ausgang ist hier über das DMX512-A Protokoll einzeln ansteuerbar.

Der QuickFix™ Low Voltage Controller ist mit folgenden Power Supplies kompatibel: 35W, 70W, 90W, 120W oder 200W



QuickFix™ Low Voltage Controller
4dmx 200 W

202-205
max. Belastbarkeit: 200 W (220C)
160 x 55 x 80 mm, 1 kg



siehe Seite 132

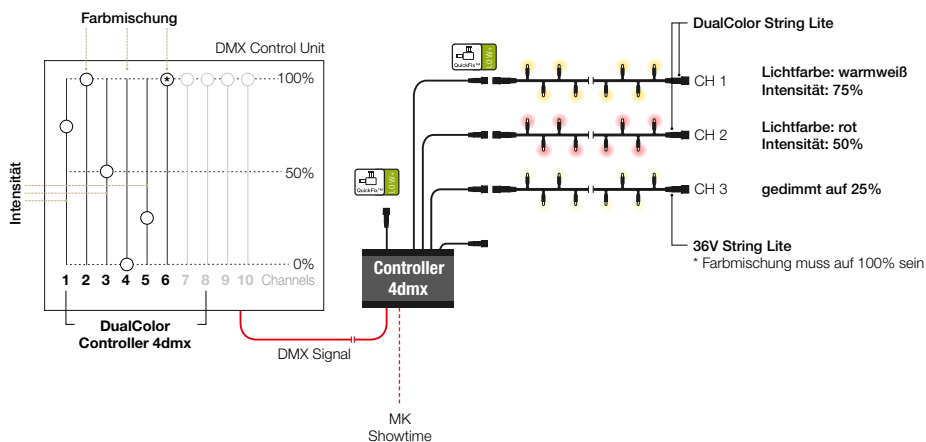
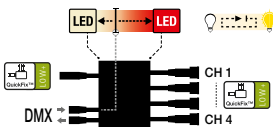



ANIMATED LIGHT

PRE
ANIMATED

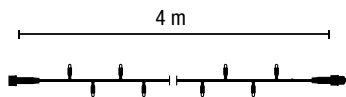

NEW

RGB

String Lite® / Rope Light

- // individuelle Lichtpunktsteuerung
- // Power Supply erforderlich
- // transparentes PVC Kabel
- // koppel- und erweiterbar
- // nicht DMX kompatibel
- // Controller erforderlich

Die neue RGB preprogrammed Serie bietet für kleine und mittelgroße Dekorationen eine einfache Möglichkeit für bunte Animationen.

Vorprogrammierte Effekte im Controller können nur mit Hilfe einer Fernbedienung eingestellt werden. Es besteht die Möglichkeit, mehrere Controller parallel zu kombinieren.



QuickFix™ Low Voltage+
PVC & Rubber 36 V | 2 W

36V LED RGB String Lite® 40

	029-680
	029-682

Länge: 4 m
Anzahl der Segmente: 1
Lampen pro Segment: 40
Länge pro Segment: 1.00 m
LED: 40

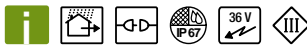

// max. 10 Ketten koppelbar



QuickFix™ Low Voltage+
PVC 36 V | 4 W

36V LED RGB String Lite® 80

	029-681
--	---------

Länge: 4 m
Anzahl der Segmente: 1
Lampen pro Segment: 80
Länge pro Segment: 1.00 m
LED: 80

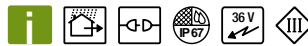

// max. 5 Ketten koppelbar



QuickFix™ Low Voltage+
PVC 36 V | 22.5 W

36V LED RGB Rope Light 15 m

	245-038
--	---------

Ø 13 mm
max. Länge: 15 m
Lampen pro Segment: 10
Länge pro Segment: 0.33 m 4.2 U
Watt/Segment: 0.5 W 1 C
LED: 450

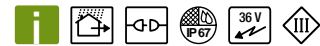

ACCESSORIES



RGB Controller

202-009
max. Belastbarkeit: 60 W (66C)
111 x 51 x 30 mm, 0.2 kg



RGB Remote Control

202-010
inkl. CR2032
106 x 50 x 15 mm, 0.06 kg



QuickFix™ Low Voltage+
Power Supply

► Siehe Seite 135

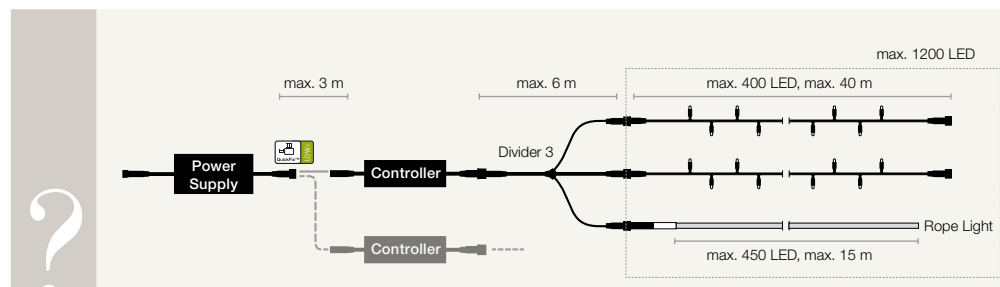

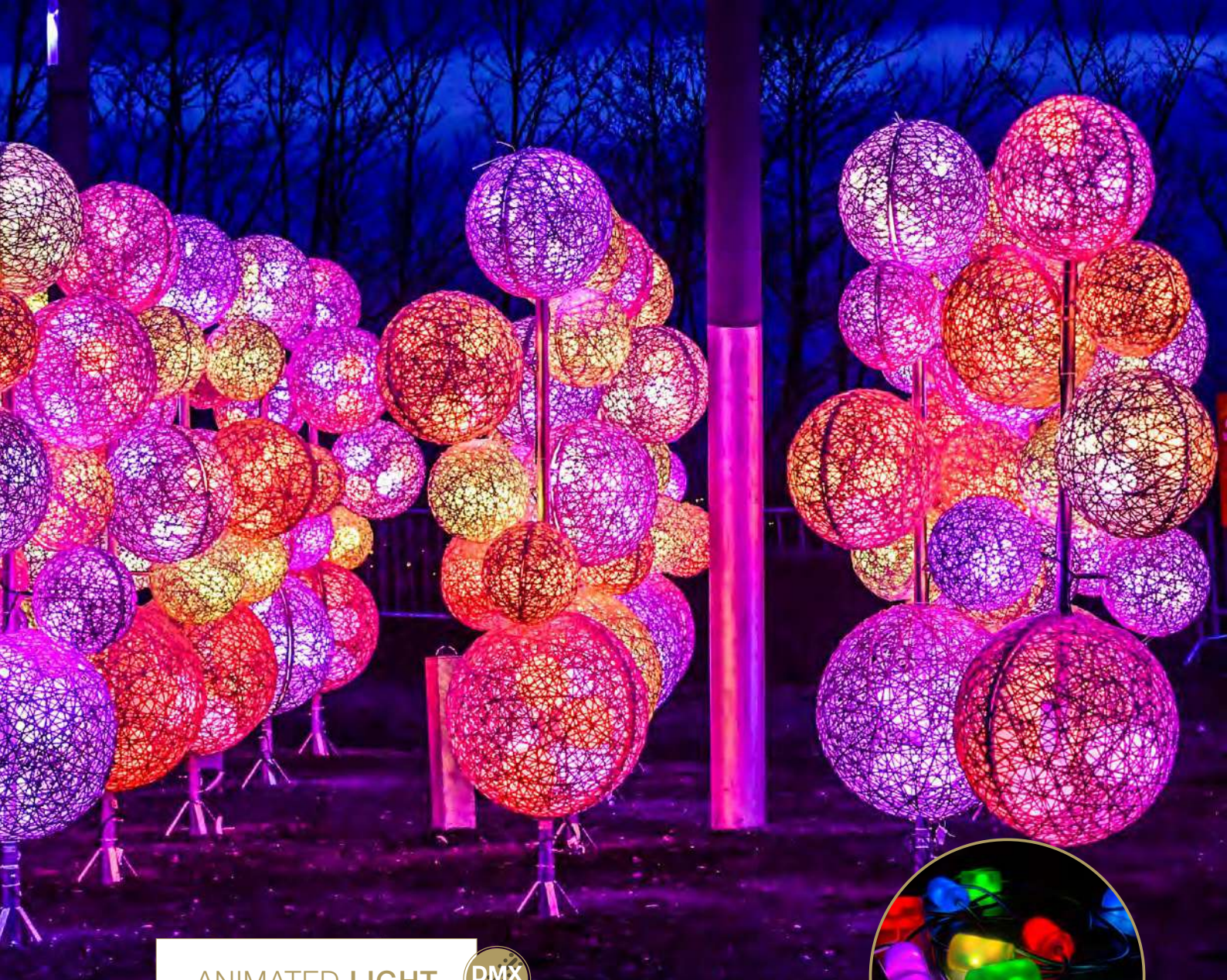

ANIMATED LIGHT

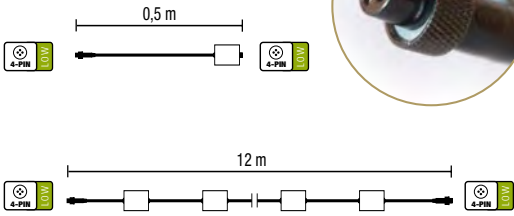

i-Ball

- // individuelle Lichtpunktsteuerung
- // Power Supply erforderlich
- // schwarzes PVC Kabel
- // koppel- und erweiterbar
- // 4-PIN Signalkabel – nicht QuickFix™ kompatibel
- // Controller erforderlich

Das i-Ball System besteht aus einer zylinderförmigen RGB Lichtquelle. Die Lichtpunkte adressieren sich selber, wobei jede per DMX individuell angesteuert werden kann. Die Lichtpunkte können am besten in Organic Objekten, Orbitals, oder auch in den halbdurchlässigen i-Ball Globe-Covers verbaut werden.



i-Ball Low Voltage
PVC 36 V

36V LED i-Ball® 1



011-144

Dimension: Ø 38 cm x 0.5 m
Anzahl der Segmente: 1
Lampen pro Segment: 1
36 V, 2.5 W, LED: 1



i-Ball Low Voltage
PVC 36 V

36V LED i-Ball® 10



011-145

Dimension: Ø 38 cm x 12 m
Anzahl der Segmente: 1
Lampen pro Segment: 10
36 V, 25 W, LED: 10

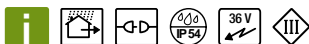
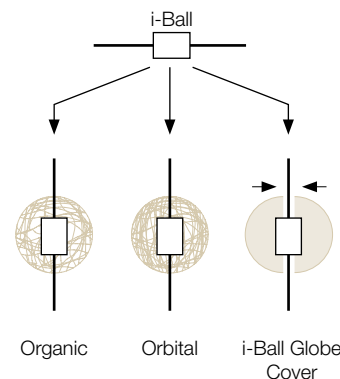

DMX ANIMATED ACCESSORIES

i-Ball Extension 0.5

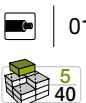

i-Ball Extension 1

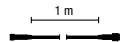
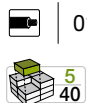

i-Ball Globe Cover 140

011-152
Ø 140 mm



i-Ball Extension 3

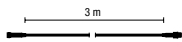

i-Ball Extension 5

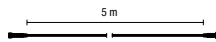
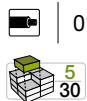

i-Ball Globe Cover 200

011-153
Ø 200 mm



i-Ball Extension 10

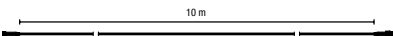
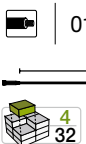

i-Ball T-Divider

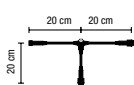

i-Ball Signal Converter

202-008
max. Belastbarkeit:
125 W (137.5C)
53 x 36 x 23 mm, 0.14 kg

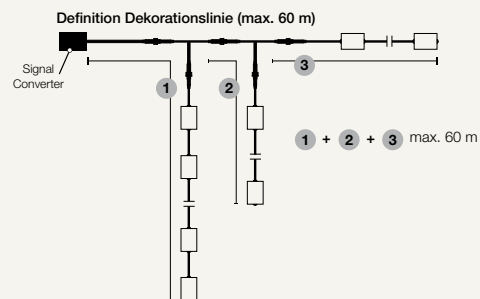
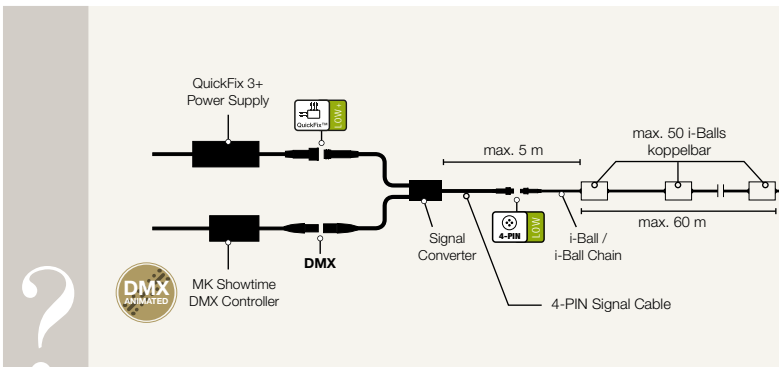
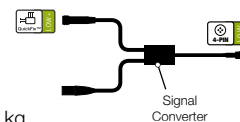



ANIMATED LIGHT



Designer Outlet, London – UK



Edison XL

RGB

// Power Supply erforderlich

// koppel- und erweiterbar

// Controller erforderlich



QuickFix™ Low Voltage+
PVC 36 V | 10,8 W

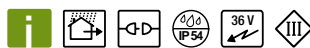

36V LED Edison XL RGB



029-156

Dimension: 0.28 m x 0.28 m x 0.5 m
36 V, 10.8 W, 1.50 kg



siehe Seite 132

ACCESSORIES



QuickFix™ Low Voltage+
Power Supply

► Siehe Seite 135



ACCESSORIES

Controller



202-005

inkl. Fernbedienung, inkl. CR2025
150 x 65 x 40 mm, 0,20 kg

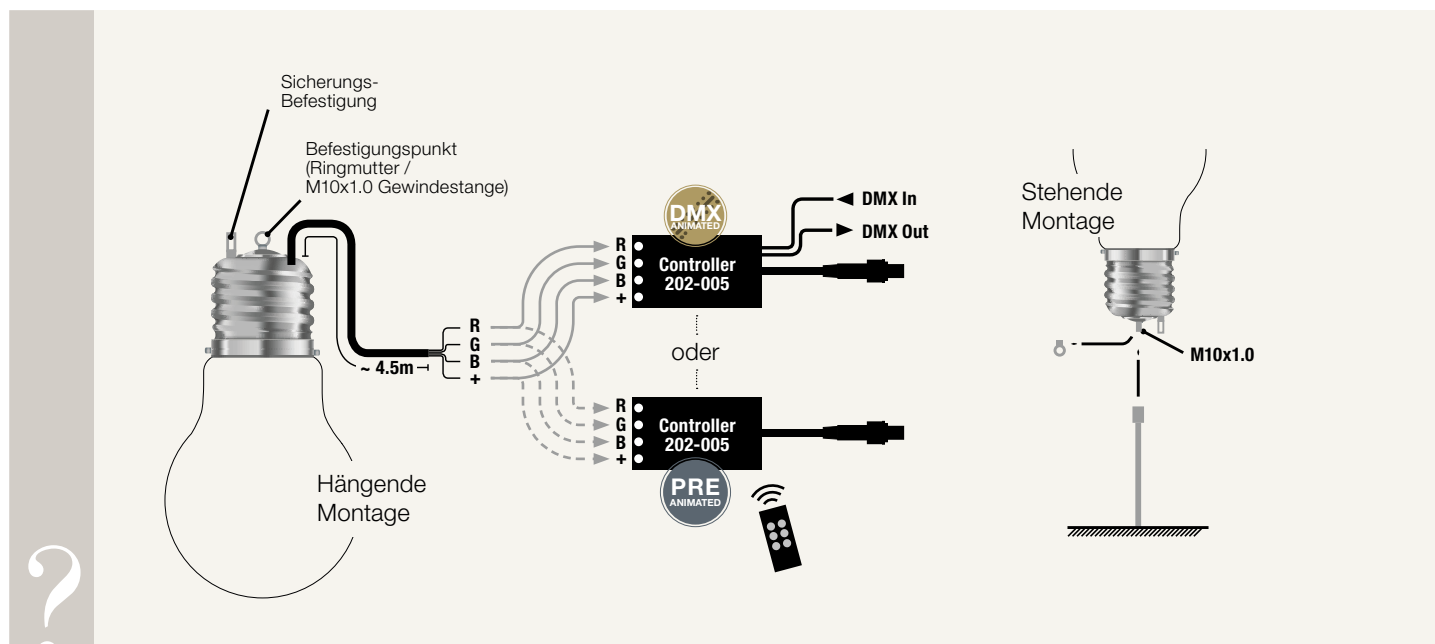



ANIMATED LIGHT

PRE
ANIMATED

Lohja – Finland

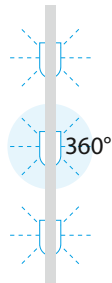
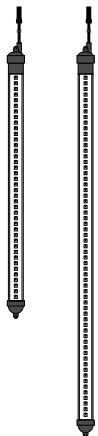

360°
Lichtabstrahlwinkel

Ice Drop[®]

Ohne Netzstecker

// kein Power Supply notwendig

// hohe Leuchtkraft

// koppel- und erweiterbar

// 360° Effekt

// max. 50 koppelbar



QuickFix™ Outdoor+ 220-230 V | 3.5 W



019-274

Dimension: Ø 5 x 89 cm
LED: 64



QuickFix™ Outdoor+ 220-230 V | 3.5 W



019-278

Dimension: Ø 5 x 126 cm
LED: 96

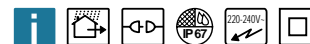

ACCESSORIES



QuickFix™ Main Connector

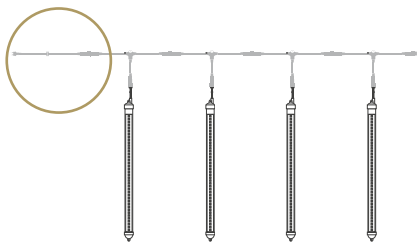

	EU	UK	CH	AU
	001-001	001-003	001-005	001-007
	001-002	001-004	001-006	001-008

Anschluss: Zuleitung an QuickFix™
max. Belastbarkeit: 1800 W (820C)



LED QuickFix™ Main Connector

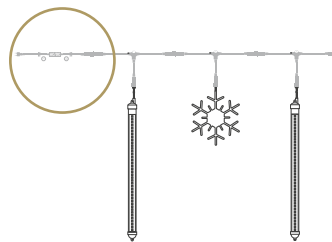

	EU	UK	CH	AU
	001-011	001-013	001-015	001-017
	001-012	001-014	001-016	001-018

Anschluss: Zuleitung an LED QuickFix™
mit Gleichrichter, max. Belastbarkeit: 480 W (220C)



QuickFix™ Divider 2



001-121



001-122

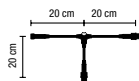

T-Verbinder, Verteilerkabel
mit 2 Ausgängen



QR Code

- 1 ... Langsam
- 2 ... Mittel (Standard)
- 3 ... Schnell

Ice Drop®

Empfänger für Geschwindigkeitsregelung

Control Stick (Magnet)

Snowfall® Tube



ANIMATED LIGHT

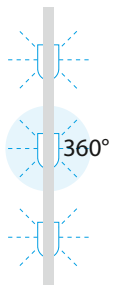
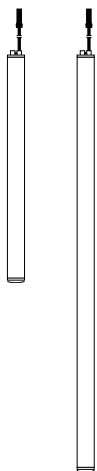

360°

360°
Lichtabstrahlwinkel

Snowfall[®]

Tubes / Bulbs

Ohne Netzstecker

// Power Supply erforderlich

// hohe Leuchtkraft

// koppel- und erweiterbar

// 360° Effekt



QuickFix™ Low Voltage+
PVC 36 V | 5 W

36V Snowfall Tube 50

		029-178
		029-179
		029-180
		029-182

Dimension: Ø 4 x 51 cm
LED: 120

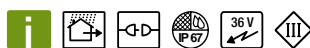

// max. 40 koppelbar



QuickFix™ Low Voltage+
PVC 36 V | 3.5 W

36V Edison L

		029-197
		029-198

Dimension: Ø 15 x 25 cm
LED: 100

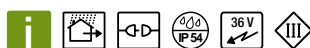

// max. 55 koppelbar



QuickFix™ Low Voltage+
PVC 36 V | 5 W

36V Snowfall Tube 100

		029-173
		029-174
		029-175
		029-177

Dimension: Ø 4 x 100 cm
LED: 240

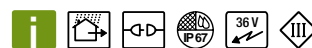

// max. 40 koppelbar



QuickFix™ Low Voltage+
PVC 36 V | 3.5 W

36V Edison XL

		029-195
		029-196

Dimension: Ø 28 x 50 cm
LED: 140

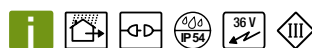

// max. 55 koppelbar

ACCESSORIES



QuickFix™ Low Voltage+
Power Supply

► Siehe Seite 135

36V Snowfall Neverdim 50

		029-210
		029-212

Dimension: Ø 4 x 67 cm
LED: 120



36V Snowfall Neverdim 100

		029-211
		029-213

Dimension: Ø 4 x 117 cm
LED: 240

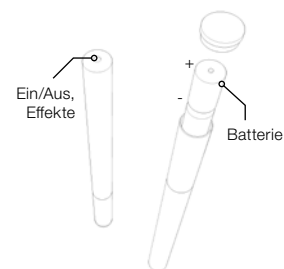

Snowfall Neverdim
Batteriebetrieb ohne
Helligkeitsverlust

Mit der neuen Neverdim-Technology ist ein Batteriebetrieb auch bei professioneller Beleuchtung möglich. Nur 2 D-Zellen Batterien betreiben so den Neverdim Snowfall mit einer Laufzeit von ungefähr 40 Tagen (Timer 6h pro Tag / Snowfall Effekt)

Modi:

- Dauer-Ein
- Timer mit 6h Betrieb pro Tag
- Timer mit 12h Betrieb pro Tag

Animationseffekte:

- Alle LED's an
- Zufälliges Blinken einzelner LED's
- Snowfall Effekt



Infinity Star



Echo Star 30



Echo Star 60



ANIMATED LIGHT

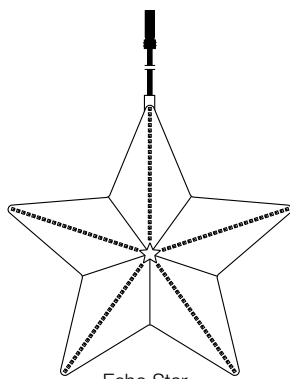

Echo Star

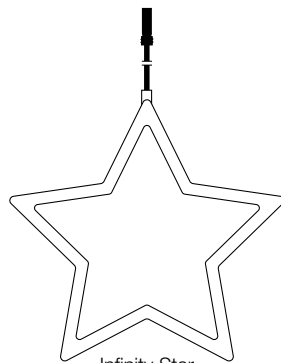

Infinity Star

Snowfall® Fading

- // Power Supply erforderlich
- // transparentes PVC Kabel
- // koppel- und erweiterbar
- // gute Tagwirkung



QuickFix™ Low Voltage+
PVC | 4.5 W

36V Echo Star 30

		029-188
		029-192

Dimension: Ø 0.3 m
36 V, LED: 100, 0.3 kg

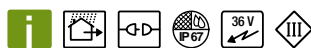

QuickFix™ Low Voltage+
PVC 36 V | 4.5 W

36V Echo Star 60

		029-183
		029-187

Dimension: Ø 0.6 m
36 V, LED: 140, 1.2 kg

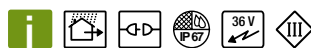

QuickFix™ Low Voltage+
PVC 36 V

36V Infinity Star 60

	029-193
--	---------

Dimension: Ø 0.6 m
36 V, 8.6 W, LED: 194, 0.5 kg



36V Infinity Star 30

	029-194
--	---------

Dimension: Ø 0.3 m
36 V, 0.25 W, LED: 66, 0.3 kg

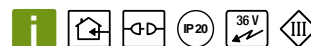

// nur für den Innengebrauch!



QuickFix™ Low Voltage+
PVC 36 V | 3.6 W

36V Star Fading

	029-158
--	---------

Dimension: Ø 50 cm
36 V, 1.7 kg

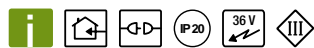

// nur für den Innengebrauch!



QuickFix™ Low Voltage+
PVC 36 V | 3.6 W

36V Flake Fading

	029-160
--	---------

Dimension: Ø 50 cm
36 V, 1.9 kg

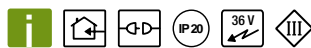

// nur für den Innengebrauch!

ACCESSORIES



QuickFix™ Low Voltage+
Power Supply

▶ Siehe Seite 135



Doppelseitiger
Lichteffekt

QuickFix™
SYSTEM

Mit jedem Lighting-
Produkt von
MK Illumination
dürfen Sie ein
Qualitätsversprechen
verbinden.



QuickFix™
OUTOOR+



Robust, wetterbeständig
und montagefreundlich.

QuickFix™ Outdoor 230V Gummilichterketten
eignen sich wunderbar für das Schmücken von
Bäumen, Fassaden oder ganzen Gebäuden.
Sie werden nach Schutzart IP67 gebaut und
sind ausschließlich untereinander koppel- und
erweiterbar.

Das Epoxydharz, mit dem die LEDs in die
Polycarbonatkappen eingegossen und versiegelt
sind, garantiert einen sicheren Kontakt und
optimalen Schutz vor Feuchtigkeit.

- // kein Power Supply notwendig
- // koppel- und erweiterbar
- // Segmente austauschbar
- // Schutzart IP67
- // **ohne Netzstecker**
- // inklusive Endkappe

Schutzart
IP67





QuickFix™ INDOOR



Elegant und transparent – die sichersten Indoor-Lichterketten am Markt.

Alle QuickFix™ Indoor 230V PVC Lichterketten sind ausschließlich untereinander koppel- sowie erweiterbar. Diese Produkte sind MKs Highlights auf Christbäumen, Girlanden und Kränzen. Das Epoxydharz, mit dem die LEDs in die Polycarbonatkappen eingegossen und versiegelt sind, schafft einen dauerhaften, sicheren Kontakt.

- // kein Power Supply notwendig
- // koppel- und erweiterbar
- // transparentes Kabel
- // Segmente austauschbar
- // Schutzart IP20
- // **ohne Netzstecker**
- // inklusive Endkappe

Schutzart
IP20



QuickFix™ LOW VOLTAGE+



Für innen und außen – die professionellste Niedervolt Lichterkette am Markt.

Mit dem MK Low Voltage+ System können im Vergleich zu anderen Niedervoltssystemen, Systemlängen bis zu 80 Meter realisiert werden. Das Epoxydharz, mit dem die LEDs in die Polycarbonatkappen eingegossen und versiegelt sind, garantiert einen sicheren Kontakt und gibt Schutz vor Feuchtigkeit. Die montagefreundlichen QuickFix™ Low Voltage+ 36V Lichterketten sind ausschließlich untereinander koppel- sowie erweiterbar. Durch die Schutzkleinspannung (SELV) eignen sie sich besonders gut für Dekorationen im Handbereich sowie wenn Niedervolt vorgeschrieben wird.

- // **Power Supply erforderlich**
- // koppel- und erweiterbar
- // schwarzes Gummikabel
- // transparentes und grünes PVC Kabel
- // Segmente austauschbar
- // Schutzart IP67
- // inklusive Endkappe

Schutzart
IP67



QuickFix™ OUTDOOR+ / QuickFix™ INDOOR

Point System

Decoration Planning

Bisher waren die Angaben zur maximalen Koppelbarkeit auf ein Produkt innerhalb einer Dekorationslinie bezogen. Somit gab es keine klaren Angaben beim Zusammenschluss von unterschiedlichen Produkten und bei mehreren Dekorationslinien.

Dieses neue QuickFix™ Point System berücksichtigt nun alle QuickFix™ koppelbare Produkte in unserem Sortiment, egal ob 230V oder Low Voltage. Durch die klare Definition der Dekorationslinien, dem einheitlichen Punkt der Kalkulation und dem einfachen Addieren der C und U Werte, lassen sich nun schnell und einfach auch komplexe Dekorationen mit unterschiedlichsten QuickFix™ Produkten planen.

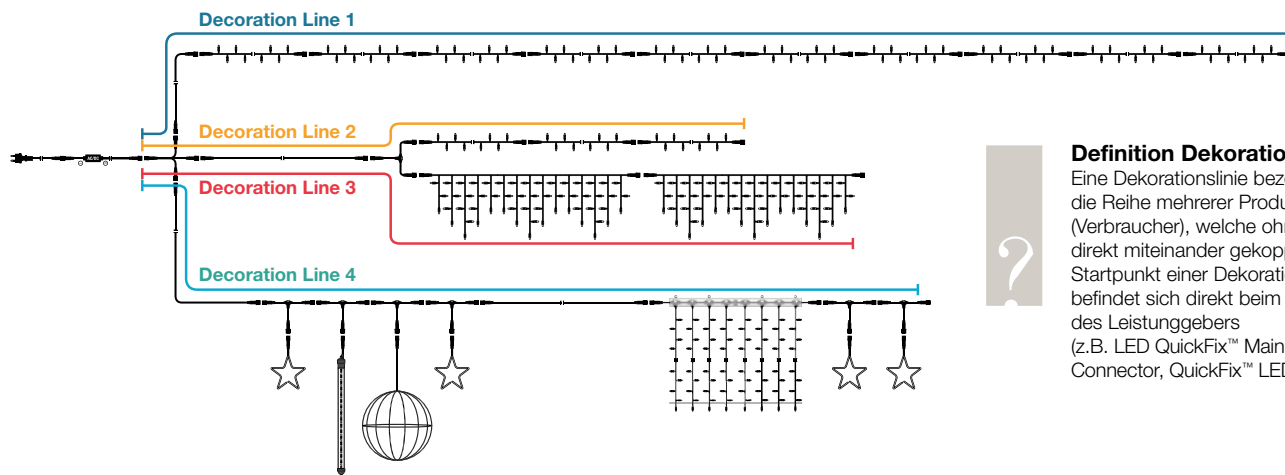

Definition Dekorationslinie:

Eine Dekorationslinie bezeichnet die Reihe mehrerer Produkte (Verbraucher), welche ohne Verteiler direkt miteinander gekoppelt sind. Startpunkt einer Dekorationslinie befindet sich direkt beim Ausgang des Leistunggebers (z.B. LED QuickFix™ Main Connector, QuickFix™ LED Box etc.).

I QuickFix™ Units U

U definiert die maximale Länge einer Dekorationslinie, welche mit maximal 200 U belastet werden darf.

12 U

Beispiel: LED String Lite® 120 - 12m

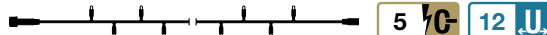

Beispiel: QuickFix™ Extension 3



II QuickFix™ Capacity C

Energieverbrauch der gesamten Dekoration mit allen Dekorationslinien. Produkte können Energie geben (C+) oder nehmen (C-). Der Gesamtwert den ein C+ Leistungsgeber bietet, darf von den C- Leistungsnehmern aller angeschlossenen Dekorationslinien in Summe nicht überschritten werden.

220 **C+**

C+ Leistungsgeber:

QuickFix™ Main Connector, QuickFix™ LED Box etc.

Beispiel: LED QuickFix™ Main Connector

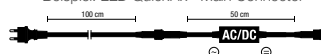

220 **C+**

5 **C-**

C- Leistungsnehmer:

LED String Lite®, LED Drape Lite® etc.

Beispiel: LED String Lite® 120 – 12 m

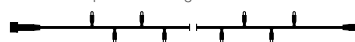

5 **C-**

12 **U.**

I

max.
200 U
pro Dekorationslinie

QuickFix™ Divider 3	QuickFix™ Extension 3	LED String Lite® 120 – 20 m	QuickFix™ Extension 10	LED String Lite® 120 – 20 m
0.5 U.	3 U.	20 U. x 5	10 U.	20 U. x 4

$$0.5 \text{ U.} + 3 \text{ U.} + 20 \text{ U.} \times 5 + 10 \text{ U.} + 20 \text{ U.} \times 4 = 193.5 \text{ U.}$$

Diese Dekorationslinie könnte noch zusätzlich 6.5U aufnehmen bis das Maximum von 200U erreicht ist.

Decoration

Decoration Line 1

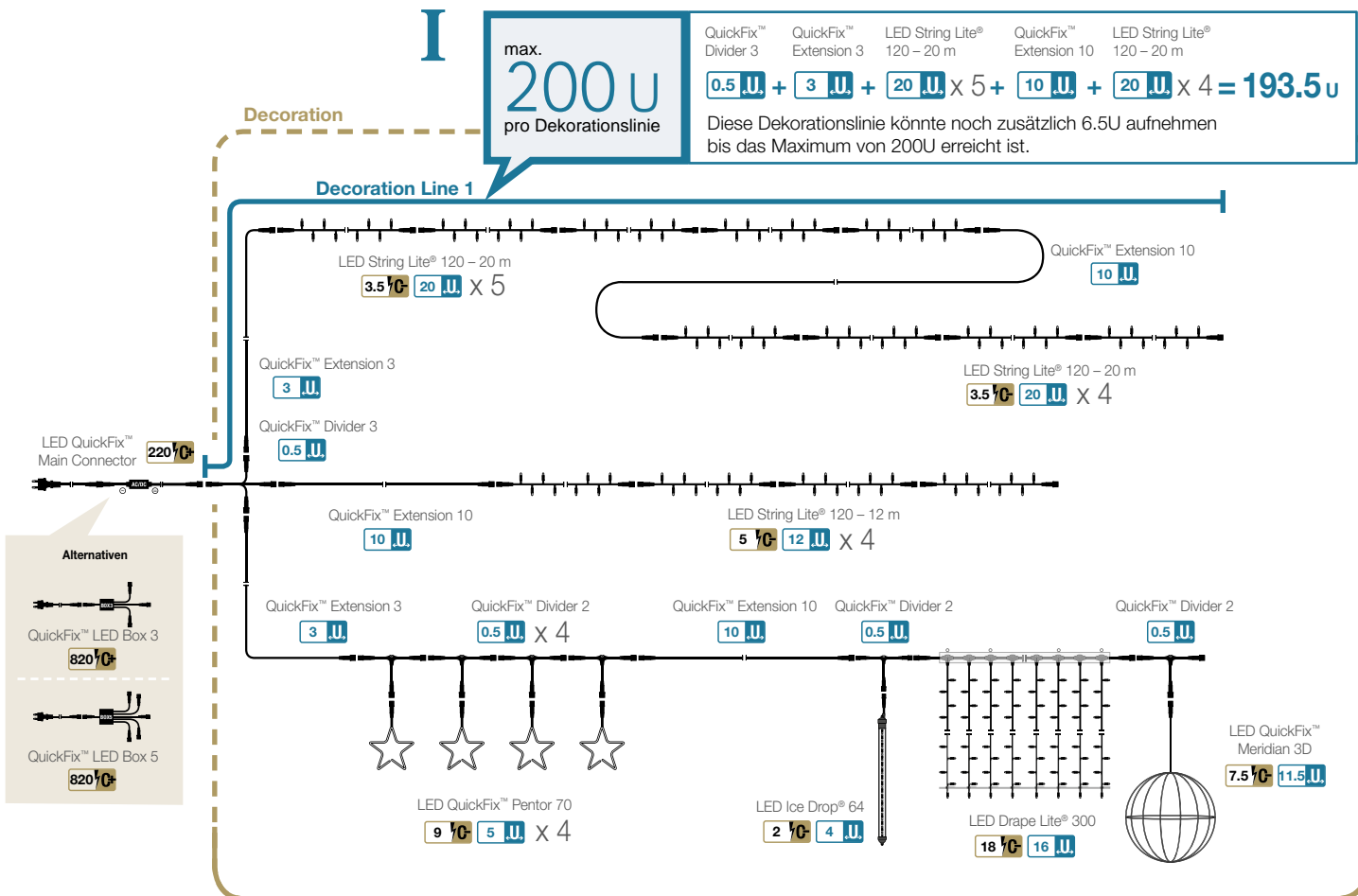

Alternativen



QuickFix™ LED Box 3
820 **C+**

QuickFix™ LED Box 5
820 **C+**

II

max.
220 C
der gesamten
Dekoration

LED String Lite® 120 – 20 m	LED String Lite® 120 – 12 m	LED QuickFix™ Pentor	LED Ice Drop® 64	LED Drape Lite® 300	LED QuickFix™ Meridian
3.5 C x 9	5 C x 4	9 C x 4	2 C	18 C	7.5 C

$$= 115 \text{ C}$$

Bei dieser Dekoration könnten noch zusätzlich Produkte mit insgesamt 105C verbaut werden bevor das Limit des LED QuickFix™ Main Connectors erreicht ist.

QuickFix™ OUTDOOR+ *Accessories*

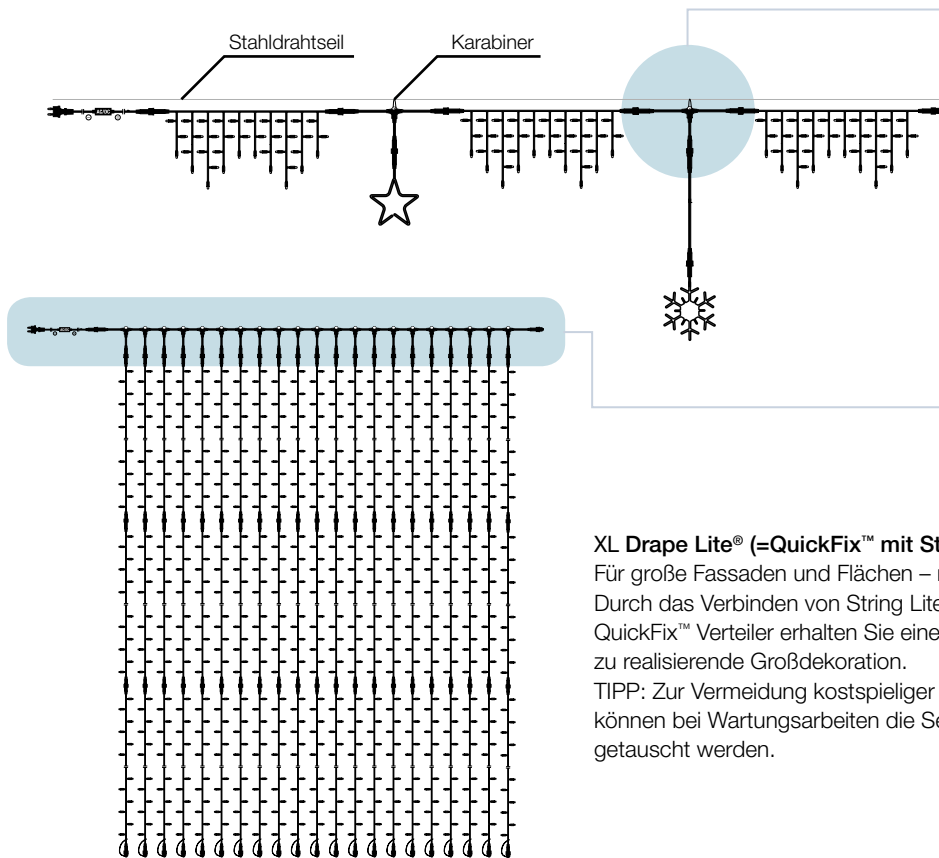

XL Drape Lite® (=QuickFix™ mit String Lite®)

Für große Fassaden und Flächen – mit 8 m und mehr!

Durch das Verbinden von String Lite® mit einem QuickFix™ Verteiler erhalten Sie eine einfach und schnell zu realisierende Großdekoration.

TIPP: Zur Vermeidung kostspieliger Neumontagen, können bei Wartungsarbeiten die Segmente einzeln getauscht werden.

QuickFix™ LED-Box 3

001-033

Verteilerdose zum Anschließen von QuickFix™ LED Produkten, IP67, mit eingebauter Überlastsicherung
 Summe aller Ausgänge darf 1800W nicht überschreiten
 max. Belastbarkeit pro Ausgang: 1800W
 Zuleitung: QuickFix™ (10-16A) IP67, 3x1,5mm², Sicherung: T8,0A/250V
 90 x 60 x 40 mm
 0.35 kg
ohne Netzstecker

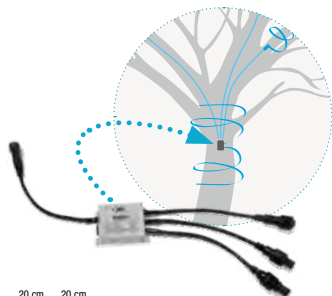

QuickFix™ Divider 2

001-121
 001-122

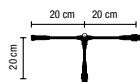

T-Verbinder, Verteilerkabel mit 2 Ausgängen



QuickFix™ Divider 6

001-127
 001-128

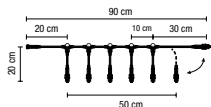

Verteilerkabel mit 6 Ausgängen



QuickFix™ Divider 21

001-131
 001-132

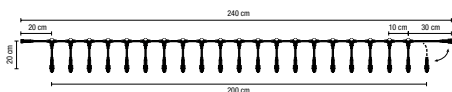

Verteilerkabel mit 21 Ausgängen



Universal Mounting Track

014-855
 Länge: 2.08 m
 Produkt für Drape Lite® (Outdoor, Indoor),
 Divider und E14 String Lite®

- ① Alu-Schiene
- ② Fixierungsstange mit Kabelbinder
- ③ Kunststoffbolzen

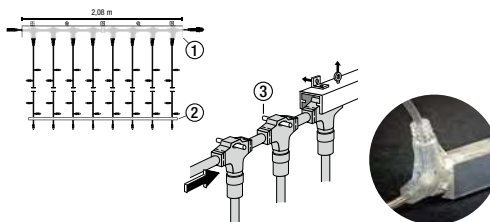

Spare-Pin for Mounting Track

015-367
 Inhalt: 20



QuickFix™ LED-Box 5

001-034

Verteilerdose zum Anschließen von QuickFix™ LED Produkten, IP67, mit eingebauter Überlastsicherung
 Summe aller Ausgänge darf 1800W nicht überschreiten
 max. Belastbarkeit pro Ausgang: 1800W
 Zuleitung: QuickFix™ (10-16A) IP67, 3x1,5mm²,
 Sicherung: T8,0A/250V, 90 x 60 x 40 mm
 0.60 kg
ohne Netzstecker



QuickFix™ Divider 3

001-125
 001-126

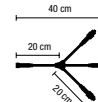

Verteilerkabel mit 3 Ausgängen



QuickFix™ Divider 11

001-129
 001-130

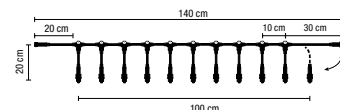

Verteilerkabel mit 11 Ausgängen



i

- verbindet gekennzeichnete 230V Outdoor Produkte
- einzeln qualitätsgeprüft
- Schutzart IP67

Max. Belastbarkeit des Hauptkabels: 1800W (820C).
 Pro Ausgang das Maximum der zu koppelnden Gummiprodukte nicht überschreiten!

QuickFix™ OUTDOOR+ *Accessories*

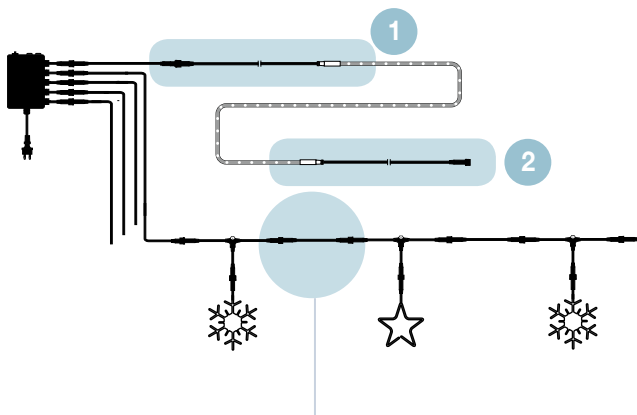

QuickFix™ Extension 1



001-103
001-104

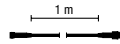

Verlängerungskabel 1m
max. Belastbarkeit: 1800 W (820C)



siehe Seite 124

QuickFix™ Extension 10



001-109
001-110



Verlängerungskabel 10m
teilbar in 2 Segmente á 5m
max. Belastbarkeit: 1800 W (820C)



siehe Seite 124

QuickFix™ Extension 0.5



001-101
001-102



Verlängerungskabel 0.5m
max. Belastbarkeit: 1800 W (820C)



siehe Seite 124

QuickFix™ Extension 3



001-105
001-106

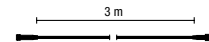

Verlängerungskabel 3m
max. Belastbarkeit: 1800 W (820C)



siehe Seite 124

QuickFix™ Extension 20



001-111

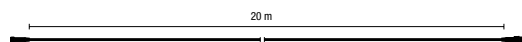

Verlängerungskabel 20m
max. Belastbarkeit: 1800 W (820C)



siehe Seite 124

QuickFix™ Main Connector

	EU	UK	CH	AU
	001-001	001-003	001-005	001-007
	001-002	001-004	001-006	001-008

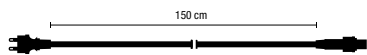

Anschluss: Zuleitung an QuickFix™
max. Belastbarkeit: 1800 W (820C)



LED QuickFix™ Main Connector

	EU	UK	CH	AU
	001-011	001-013	001-015	001-017
	001-012	001-014	001-016	001-018



Anschluss: Zuleitung an LED QuickFix™
mit Gleichrichter, max. Belastbarkeit: 480 W (220C)



LED QuickFix™ Outdoor Adapter

	001-031	
	001-032	

Adapter: LED Gummiprodukte an QuickFix™
max. Belastbarkeit: 480 W (220C)



LED Main Connection Set

001-021		
001-023		
001-025		

Anschluss-Set für LED Lichtschlauch, inkl. AC/DC-Wandler,
mit Endkappe, Lösungsmittelkleber, Einspeisepin und
2 Schrumpfschläuchen, max. Belastbarkeit: 480 W

1 QuickFix™ Ropelight Adapter

	001-141	
	001-142	
	001-143	

Adapter: QuickFix™ an ROPE LIGHT
mit Endkappe, Lösungsmittelkleber,
Einspeisepin und 2 Schrumpfschläuchen
max. Belastbarkeit: 740 W (330C)



2 Ropelight Extension to QuickFix™

	001-144	
	001-145	
	001-146	

Adapter: ROPE LIGHT an QuickFix™
mit Endkappe, Lösungsmittelkleber,
Einspeisepin und 2 Schrumpfschläuchen
max. Belastbarkeit: 740 W (330C)



QuickFix™ Adapter Set

max. Belastbarkeit: 1800 W (820C)

001-799

Adapter: QuickFix™ Outdoor to QuickFix™ Outdoor+
(1x Type A, 1x Type B)

NEW! 001-795
(5x Type A)



NEW! 001-796
(5x Type B)



QuickFix™ Accessories

001-704

3 Muttern,
3 Endkappen,
3 Farbkodierte Dichtringsets*
3 Schrumpfschläuche

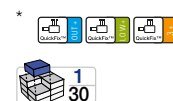

QuickFix™ Click Nut

001-701
 001-702



Verpackungsinhalt: 10

QuickFix™ INDOOR *Accessories*

QuickFix™ Divider 3

 | 007-126

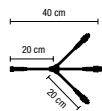

Verteilerkabel mit 3 Ausgängen
220-240 V, max. Belastbarkeit: 1500 W (680C)



QuickFix™ Divider 11

 | 007-130

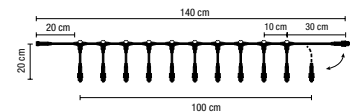

Verteilerkabel mit 11 Ausgängen
220-240 V, max. Belastbarkeit: 1500 W (680C)



QuickFix™ LED-Box 3 Indoor

 | 007-033

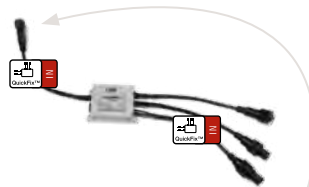

Verteilerdose zum Anschließen von QuickFix™ LED Produkten, IP20, mit eingebauter Überlastsicherung
Summe aller Ausgänge darf 1500W nicht überschreiten
max. Belastbarkeit pro Ausgang: 1500W
Zuleitung: QuickFix™ Indoor Stecker
220-240 V, 90 x 60 x 40 mm, 0,4 kg, T8,0A/250V



QuickFix™ Main Connector Indoor 007-001
+
QuickFix™ LED-Box 3 Indoor 007-033

QuickFix™ Accessories

 | 015-032

3 Endkappen,
3 Schrumpfschläuche



Drape Lite® Endcap-set

 | 015-361

2x transparente Verschlusskappe für Drape Lite® Strang Indoor/Outdoor
2x Schrumpfschlauch transparent, weiß und schwarz
2x Dichtring



LED QuickFix™ Main Connector Indoor

	EU	UK	CH	AU
	007-012	007-014	007-016	007-018
	007-011			

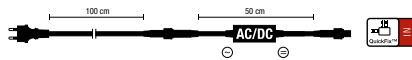

220-240 V
max. Belastbarkeit: 480 W (220C)



QuickFix™ Main Connector Indoor

	007-001
	007-002

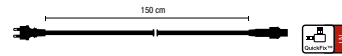

220-240 V
max. Belastbarkeit: 1500 W (680C)



QuickFix™ Extension Indoor, 1m

	007-104	
	007-103	

Verlängerungskabel 1m
220-240 V, max. Belastbarkeit: 1500 W (680C)



QuickFix™ Extension Indoor, 3 m

	007-106	
--	---------	--

Verlängerungskabel 3m
220-240 V, max. Belastbarkeit: 1500 W (680C)



QuickFix™ Extension Indoor, 10 m

	007-110	
--	---------	--

Verlängerungskabel 10m
teilbar in 2 Segmente á 5m
220-240 V, max. Belastbarkeit: 1500 W (680C)



QuickFix™ Divider 2 Indoor

	007-122
	007-121

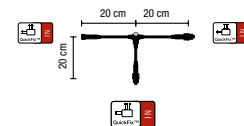

T-Verbinder, Verbinderkabel mit 2 Ausgängen
220-240 V, max. Belastbarkeit: 1500 W (680C)



QuickFix™ T-Motiv Adapter

	007-166
	007-165

T-Verbinder, Verbinderkabel mit 2 Ausgängen
220-240 V, max. Belastbarkeit: 1500 W (680C)

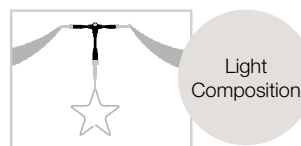
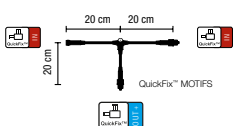

QuickFix™ LOW VOLTAGE+ Point System

Verbindungsmethodik

Ein speziell entwickeltes Verbindungssystem für die neue professionelle Niedervolt Produktserie von MK Illumination. Die hier angewandten Parameter „einfach“, „schnell“ und „sicher“ wurden auch beim neuen QuickFix™ Low Voltage+ System perfekt umgesetzt.

Achtung: Das QuickFix™ 36V System ist nicht koppelbar mit QuickFix™ 230V!

Definition Dekorationslinie:
siehe Seite 106



Vorteile

Der neue QuickFix™ + Stecker:
Ergonomisch und optisch verbessert
für das leichtere Verbinden

Das erste IP67 zertifizierte Profi-
Lichterkettensystem

Die unterschiedlichen Farb-Codes
erleichtern die Unterscheidbarkeit der
QuickFix™ + Systeme

Deutlich weniger CO₂ Emissionen durch
energiesparende LED's und einen um
80 Prozent reduzierten Stromverbrauch

Alle Produkte haben transparente
Polycarbonatkappen und Sockelhüllen für
einen brillanten 360 Grad Effekt

Die mit Epoxydharz versiegelten
Polycarbonatkappen garantierten IP44
und schützen vor Schäden durch
Zugbelastungen

Erhöhter UV Schutz durch
Polycarbonatkappen, dadurch höhere
Lebensdauer der LED

QuickFix™ Trafo Anschlüsse verschiedener
Leistungen, IP67 – Made in Germany

I QuickFix™ Units U

U definiert die maximale Länge einer Dekorationslinie, welche mit maximal 200 U belastet werden darf. (200U entsprechen 80m)

Beispiel: QuickFix™ Extension 5

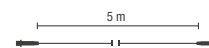

II QuickFix™ Capacity C

Energieverbrauch der gesamten Dekoration mit allen Dekorationslinien.
Produkte können Energie geben (C+) oder nehmen (C-).
Der Gesamtwert den ein C+ Leistungsgeber bietet, darf von den C-
Leistungsnehmern aller angeschlossenen Dekorationslinien in Summe
nicht überschritten werden. (220C+ entsprechen 5.500 LEDs)



C+ Leistungsgeber:
36V LED Power Supply

Beispiel:
36V LED Power Supply 400W

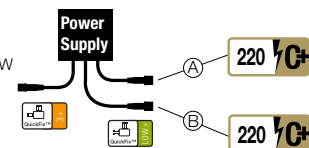

C- Leistungsnehmer:
LED StringLite®, LED DrapelLite® etc.

Beispiel: 36V LED StringLite® 120 – 12 m

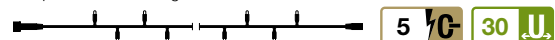

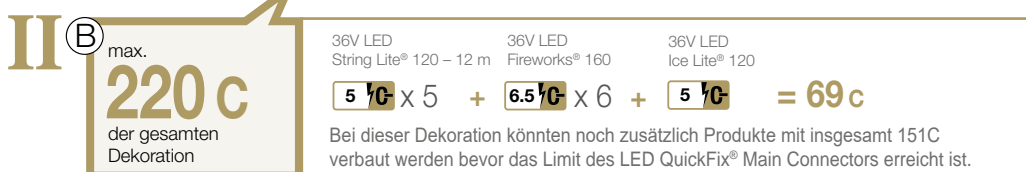
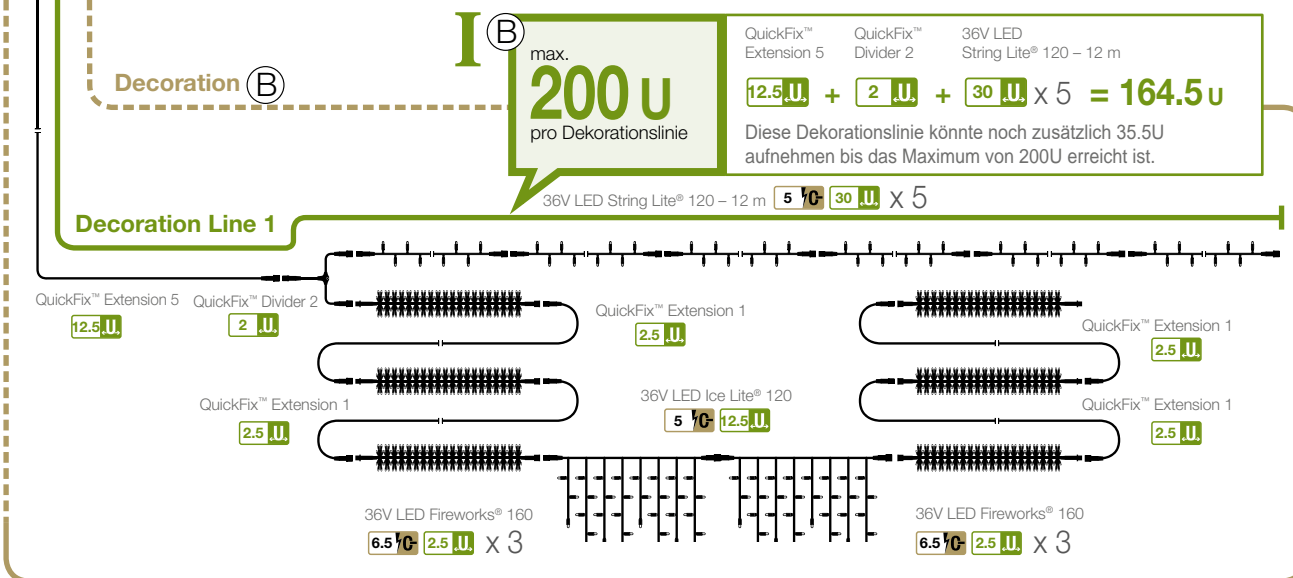
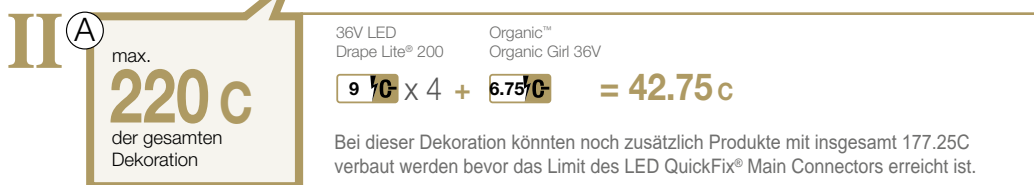
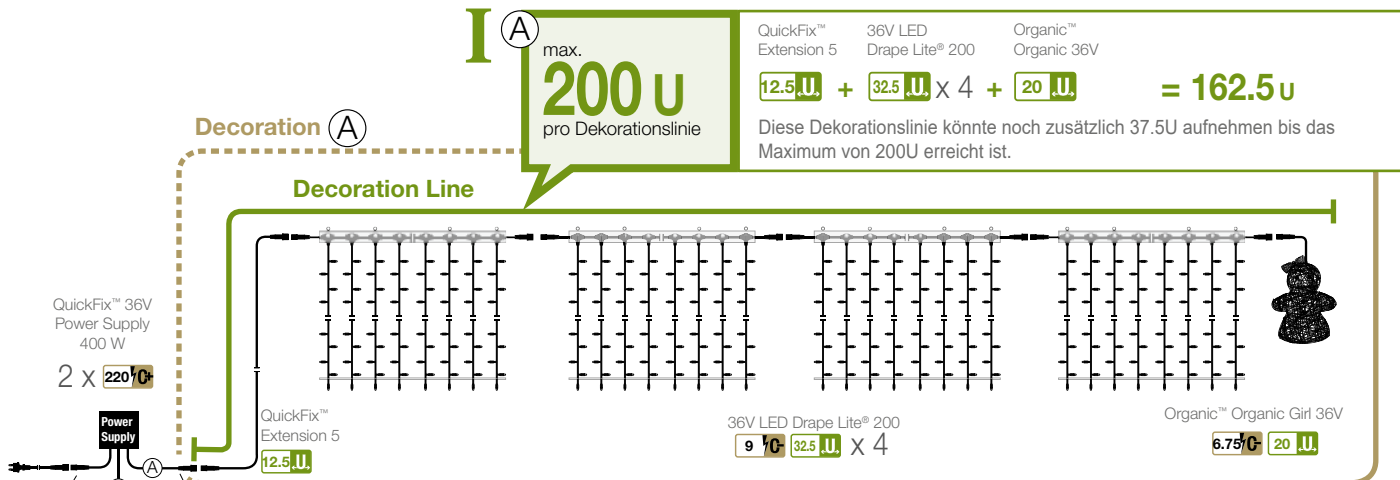

QuickFix™ LOW VOLTAGE+

QuickFix™ 3+, Power Supplies & Accessories

1

QuickFix™ 3+
Main Connector

2

QuickFix™ 36V Power Supply
100-240V AC

3

QuickFix™ Low Voltage+
Accessories & Products

1

QuickFix™ Main Connector

	EU	UK	CH	AU
	003-001	003-003	003-005	003-007
	003-002	003-004	003-006	003-008

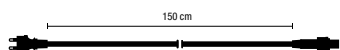

Anschluss: Zuleitung an QuickFix™
max. Belastbarkeit: 1800 W (820C)



QuickFix™ Divider 2

	003-121
	003-122

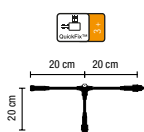

T-Verbinder, Verteilerkabel mit 2 Ausgängen
max. Belastbarkeit: 1800 W (820C)



NEW! QuickFix™ Divider 3

	003-125
	003-126

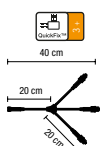

Verteilerkabel mit 3 Ausgängen
max. Belastbarkeit: 1800 W (820C)



QuickFix™ Adapter

	003-161
	003-162



Adapter: LED Gummiprodukte an QuickFix™
max. Belastbarkeit: 1800 W (820C)



QuickFix™ Extension 1

	003-103
	003-104

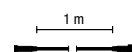

Verlängerungskabel 1m
max. Belastbarkeit: 1800 W (820C)



QuickFix™ Extension 3

	003-105
	003-106

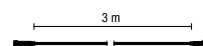

Verlängerungskabel 3m
max. Belastbarkeit: 1800 W (820C)



QuickFix™ Extension 10

	003-109
	003-110

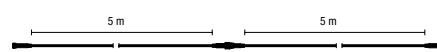

Verlängerungskabel 10m
teilbar in 2 Segmente á 5m
max. Belastbarkeit: 1800 W (820C)



QuickFix™ Extension 20

	003-111
--	---------

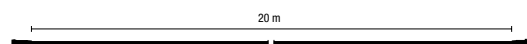

Verlängerungskabel 20m
max. Belastbarkeit: 1800 W (820C)



QuickFix™ 36V Power Supply, 7.2 W
(max. 200 LED, min. 40 LED)

002-008

DC Netzteil 7.2W, 1 Eingang, 1 Ausgang
PRI: 90-250V AC
SEC: 36V DC (0.2A)
80 x 35 x 23 mm
0.15 kg

7.9 **30**
siehe Seite 132

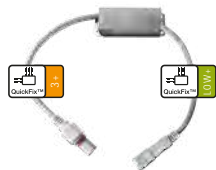

QuickFix™ 36V Power Supply, 18 W
(max. 500 LED, min. 100 LED)

002-009

DC Netzteil 18W, 1 Eingang, 1 Ausgang
PRI: 90-250V AC
SEC: 36V DC (0.5A)
162 x 35 x 23 mm
0.30 kg

19.8 **30**
siehe Seite 132

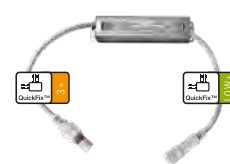

QuickFix™ 36V Power Supply, 35 W
(max. 975 LED, min. 195 LED)

002-010

DC Netzteil 35W, 1 Eingang, 1 Ausgang
PRI: 90-250V AC
SEC: 36V DC (0.97A)
172 x 42.5 x 34 mm, 0.48 kg

38.5 **30**
siehe Seite 132

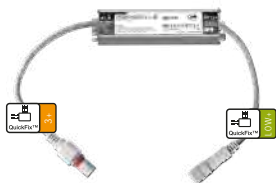

QuickFix™ 36V Power Supply, 70 W
(max. 1975 LED, min. 390 LED)

002-011

DC Netzteil 70W, 1 Eingang, 1 Ausgang
PRI: 90-250V AC
SEC: 36V DC (1.94A)
150 x 67.5 x 36.5 mm, 0.75 kg

77 **30**
siehe Seite 132

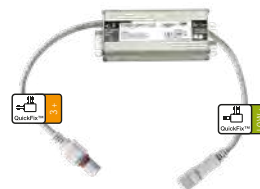

NEW! **QuickFix™ 36V Power Supply, 90 W**
(max. 2500 LED, min. 500 LED)

002-018

DC Netzteil 90W, 1 Eingang, 1 Ausgang
PRI: 90-250V AC
SEC: 36V DC (2.5A)
174 x 67.5 x 36.5 mm, 0.95 kg

99 **30**
siehe Seite 132

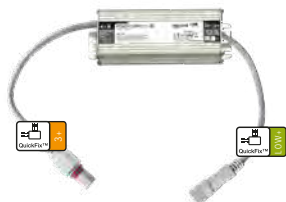

QuickFix™ 36V Power Supply, 120 W
(max. 3300 LED min. 660 LED)

002-012

DC Netzteil 120W, 1 Eingang, 1 Ausgang
PRI: 90-250V AC
SEC: 36V DC (3.33A)
199 x 67.5 x 39.5 mm, 1 kg

132 **5**
siehe Seite 132



QuickFix™ 36V Power Supply, 200 W
(max. 5500 LED min. 1100 LED)

002-013

DC Netzteil 200W, 1 Eingang, 1 Ausgang
PRI: 90-250V AC
SEC: 36V DC (5.56A)
199 x 67.5 x 39.5 mm, 1 kg

220 **5**
siehe Seite 132



i

LED Mindestbelastung

Die Netzteile 7.2, 18, 35, 70, 90, 120, 200, 400 und 800 W benötigen für den korrekten Betrieb eine Mindestbelastung wie angegeben. Wird diese Mindestbelastung unterschritten, kann die angeschlossene Lichterkette flackern.

ACHTUNG: Die Angabe der LED's für die min./max. LED-Anzahl gelten nicht für die Produktserien Decro und Strip Lite.



QuickFix™ LOW VOLTAGE+
QuickFix™ 3+, Power Supplies & Accessories

1

**QuickFix™ 3+
 Main Connector**

2

**QuickFix™ 36V Power Supply
 220-240V AC**

3



**QuickFix™ Low Voltage+
 Accessories & Products**

2

QuickFix™ 36V Power Supply, 200 W
 (max. 5500 LED min. 1600 LED)

 | 002-014

DC Transformator 200W, 1 Eingang, 1 Ausgang
 PRI: 230V AC (1,3A), T1,6A/250V
 SEC: 36V DC (5.56A)
 172 x 90 x 110 mm, 4,7 kg

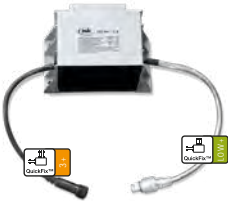

   **1**
siehe Seite 132



QuickFix™ 36V Power Supply, 800 W
 (max. 22000 LED min. 1600 LED)

 | 002-016

DC Transformator 800W, 1 Eingang, 4 Ausgänge
 PRI: 230V AC (5,1A), T6,3A/250V
 SEC: 36V DC (4 x 5.56A)
 240 x 153 x 188 mm, 21,8 kg



   **1**
siehe Seite 132



QuickFix™ 36V Power Supply, 400 W
 (max. 11000 LED min. 1600 LED)

 | 002-015

DC Transformator 400W, 1 Eingang, 2 Ausgänge
 PRI: 230V AC (2,5A), T3,15A/250V
 SEC: 36V DC (2 x 5.56A)
 172 x 90 x 159 mm, 6,9 kg

   **1**
siehe Seite 132

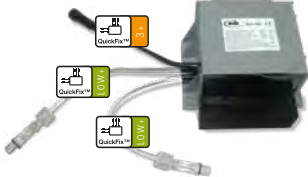

LED Mindestbelastung
 Die Netzteile 7.2, 18, 35, 70, 90, 120, 200, 400 und 800 W benötigen für den korrekten Betrieb eine Mindestbelastung wie angegeben. Wird diese Mindestbelastung unterschritten, kann die angeschlossene Lichterkette flackern.

ACHTUNG: Die Angabe der LED's für die min./max. LED-Anzahl gelten nicht für die Produktserien Decro und Strip Lite.

QuickFix™ Rope Light 36V Adapter

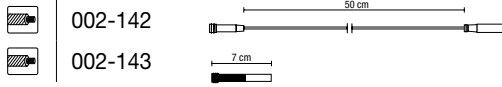

Adapter: QuickFix™ an Rope Light 36V
mit Endkappe, Lösungsmittelkleber,
Einspeisepin und 2 Schrumpfschläuchen



QuickFix™ Dimmer

202-001



QuickFix™ Low Voltage kompatibel
max. Belastbarkeit: 200 W (220C)



QuickFix™ Divider 2

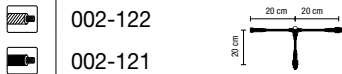

T-Verbinder, Verteilerkabel mit 2 Ausgängen
max. Belastbarkeit: 200 W (220C)



QuickFix™ Divider 3

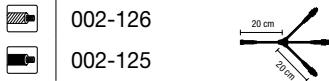

Verteilerkabel mit 3 Ausgängen
max. Belastbarkeit: 200 W (220C)



QuickFix™ Divider 11

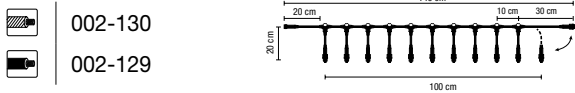

Verteilerkabel mit 11 Ausgängen
max. Belastbarkeit: 200 W (220C)



QuickFix™ Adapter Set

max. Belastbarkeit: 200 W (220C)

002-799

Adapter: QuickFix™ Low Voltage zu QuickFix™ Low Voltage+
(1x Type A, 1x Type B)

NEW! 002-795
(5x Type A)



NEW! 002-796
(5x Type B)



Rope Light 36V Extension to QuickFix™

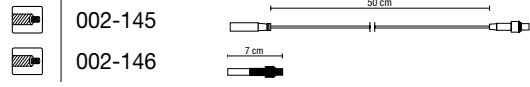

Adapter: Rope Light 36V an QuickFix™
mit Endkappe, Lösungsmittelkleber,
Einspeisepin und 2 Schrumpfschläuchen



QuickFix™ Extension 0.5

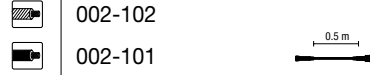

Verlängerungskabel 0.5m
max. Belastbarkeit: 200 W (220C)



QuickFix™ Extension 1



Verlängerungskabel 1m
max. Belastbarkeit: 200 W (220C)



QuickFix™ Extension 3



Verlängerungskabel 3m
max. Belastbarkeit: 200 W (220C)



QuickFix™ Extension 10



Verlängerungskabel 10m
teilbar in 2 Segmente á 5m
max. Belastbarkeit: 200 W (220C)



QuickFix™ Accessories

001-704

3 Muttern,
3 Endkappen,
3 Farbkodierte Dichtringsets*
3 Schrumpfschläuche

*



QuickFix™ Click Nut

001-703

001-701



Verpackungsinhalt: 10



MK ILLUMINATION
PRODUCTS

CANDLE LIGHT





Candle Light

Klassisch. Traditionell. Festlich.

Unsere Traditionslichterketten, in der Branche vormals bekannt als Rotpfeil® Produkte, sind altbewährte Klassiker für festliche Dekorationen.

Sie sorgen für eine stimmungsvolle und heimelige Atmosphäre im Innen- und Außenbereich. Je nach Anforderung sind die Traditionslichterketten in Flammen- oder Lampenform, mit warmweißem Licht und mit mattem oder geriffeltem Leuchtkörper erhältlich. Flexibel können die Toplampen, die Schaftlampen, die Dichtungen oder sonstiges Zubehör getauscht werden.

i

- // mit Überbrückungssicherung – nur eine Lampe fällt aus
- // Klemme für einfache Montage
- // Austauschbare Leuchtmittel
- // Leuchtmittel mit unterschiedlichem Erscheinungsbild
- // Viele Produkte auch mit Überlänge erhältlich

CANDLE LIGHT



- // Klemme für einfache Montage
- // Leuchtmittel nicht austauschbar
- // inkl. Fernbedienung
- // 72h durchgehende Leuchtdauer



Wireless

Candle Light



9681044000



10 Stück kabellose Kerzen
weißer Tropfenschaft
klare Toplampen mit Streufunktion
mit Infrarot Fernbedienung ansteuerbar (steuert mehrere Sets)

Lichteinstellungen:

7 dimmbare Helligkeitsstufen
2 einstellbare Flackerstufen

Energieversorgung: (nicht im Lieferumfang enthalten)

Lichterkette / Kerze: AA Batterie

Fernbedienung: CR 2025



QuickFix™ Candle

Type 977



QuickFix™ Outdoor+
230 V

LED	Länge	Art. Nr.
15	13.5 m	019-316 Mehrfach-LED 9771530011

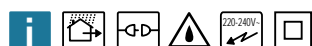

- // integrierter Dichtring
- // Lieferung ohne Netzstecker
- // max. 7 Ketten koppelbar

Lampenabstand: ca. 0.9 m
Zuleitung: ca. 0.45 m

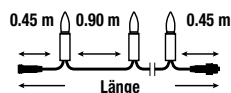

Mehrfach-LED –
Durch den Einsatz von 3 LED in der Spitze und 1 LED im Körper zaubern sie noch mehr stimmungsvolles Licht.

ACCESSORIES



QuickFix™ Main Connector

	EU	UK	CH	AU
	001-001	001-003	001-005	001-007

Anschluss: Zuleitung an QuickFix™
max. Belastbarkeit: 1800 W (820C)



~ 11,8 cm

Candle Lights

Indoor | 230 V | E10



Type 969 | E10

LED | klar & geriffelt



LED	Länge	Art. Nr.	
LED 15	10 m	2.8 W	9691505600 10
LED 20	12.5 m	2.5 W	9692005600 10
LED 30	17.5 m	2 W	9693005600 5

LED | matt & geriffelt

LED 30		9693005500	5
--------	--	------------	---

Type 969 | E10

klar & geriffelt

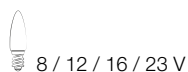

Lampen	Länge	Art. Nr.	
LED 10	7.5 m	23 V, 30 W	9691005000 10
LED 15	10 m	16 V, 45 W	9691505000 10
LED 15	23 m*	16 V, 45 W	9691505010 10
LED 20	12.5 m	12 V, 60 W	9692005000 10
LED 30	17.5 m	8 V, 90 W	9693005000 5

* Überlänge

Lampenabstand: ca. 0.5 m
Zuleitung: ca. 1.5 m
teilbarer Stecker

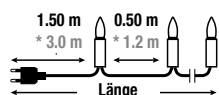

i Überlänge –
Lampenabstand: ca. 1,2 m
Zuleitung: ca. 3,0 m

~ 8,1 cm

Type 963 | E10

LED | klar & glatt



LED	Länge	Art. Nr.	
LED 15	10 m	2.8 W	9631535800 5

Type 963 | E10

klar & glatt



Lampen	Länge	Art. Nr.	
LED 15	10 m	16 V, 45 W	9631530000 5
LED 30	17.5 m	8 V, 90 W	9633030000 5

Lampenabstand: ca. 0.5 m
Zuleitung: ca. 1.5 m
teilbarer Stecker

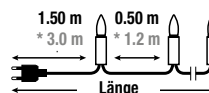

~ 11,4 cm

Candle Lights

Outdoor | 230 V



// integrierter Dichtring

Type 975 | E10

LED | klar & geriffelt



	LED	Länge		Art. Nr.	
	LED 15	15.6 m	2.8 W	9751505600	5
	LED 30	29 m	2 W	9753005600	5

LED | matt & geriffelt

	LED 15	15.6 m	2.8 W	9751505500	5
	LED 30	29 m	2 W	9753005500	5

Type 975 | E10

klar & geriffelt



	Lampen	Länge		Art. Nr.	
	15	15.6 m	16 V, 45 W	9751503000	5
	30	29 m	8 V, 90 W	9753003000	5

Lampenabstand: ca. 0.9 m
Zuleitung: ca. 1.5 m
teilbarer Stecker

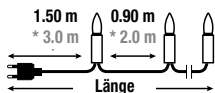

~ 9,8 cm

Type 977 | E14

LED | klar & glatt



	LED	Länge		Art. Nr.	
	LED 15	17 m	2.8 W	9771535900	5
	LED 15	34 m*	2.8 W	9771535910	5
	LED 15**	17 m	7 W	9771535901	5
	LED 15**	34 m*	7 W	9771535911	5
	LED 30	32 m	2 W	9773035900	5
	LED 30	64 m*	2 W	9773035910	5
	LED 30**	32 m	2 W	9773035901	5
	LED 30**	64 m*	2 W	9773035911	5

** Mehrfach-LED * Überlänge

Type 977 | E14

klar & glatt



	Lampen	Länge		Art. Nr.	
	15	17 m	16 V, 60 W	9771530000	5
	15	34 m*	16 V, 60 W	9771531000	5
	30	32 m	8 V, 120 W	9773030000	5

* Überlänge

Lampenabstand: ca. 1.0 m
Zuleitung: ca. 1.5 m
teilbarer Stecker

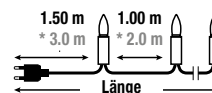

i **Mehrfach-LED –**
Durch den Einsatz von 3 LED in der Spitze und 1 LED im Körper zaubern sie noch mehr stimmungsvolles Licht.



~ 12,6 cm

CANDLE LIGHT *accessories*

Ersatzlampen

Type 963 | 974



LED Schaftlampe

Blisterkarte mit 3 Ersatzlampen
E10, 8-34V, klar & glatt

8710835890 0.4 W



Schaftlampe

Blisterkarte mit 3 Ersatzlampen
E10, klar & glatt

8601630000 16 V, 3 W

8601230000 12 V, 3 W

8600830000 8 V, 3 W



Type 969 | 970 | 974



LED Toplampe

Blisterkarte mit 3 Ersatzlampen
E10, 8-34V, klar & glatt

8710835790 0.3 W



LED Toplampe

Blisterkarte mit 3 Ersatzlampen
E10, 8-34V, matt & geriffelt

8710835590 0.3 W



LED Toplampe

Blisterkarte mit 3 Ersatzlampen
E10, 8-34V, klar & geriffelt

8710835690 0.3 W



Type 977



LED Schaftlampe

Blisterkarte mit 2 Ersatzlampen
E14, 8-34V, klar & glatt

8710835990 0.4 W

8710835992 0.6 W**

** Mehrfach-LED



Schaftlampe

Blisterkarte mit 2 Ersatzlampen
E14, klar & glatt

8611620400 16 V, 4 W

8610820400 8 V, 4 W



Toplampe

Blisterkarte mit 3 Ersatzlampen
E10, klar & glatt

8721630000 16 V, 3 W

8720830000 8 V, 3 W



Toplampe

Blisterkarte mit 3 Ersatzlampen
E10, klar & geriffelt

8702330000 23 V, 3 W

8701630000 16 V, 3 W

8701230000 12 V, 3 W

8700830000 8 V, 3 W



Zubehör



Blisterkarte mit 3 Ersatzklammern
für Außenlichterkette Type 974, 975, 977
für Innenlichterkette Type 963

8208830090 6



Blisterkarte mit 5 Ersatzdichtungen
für Außenlichterkette Type 975

8159750590 10



Blisterkarte mit 5 Ersatzklammern
für Innenlichterkette Type 969, 970

8208750090 10



Blisterkarte mit 5 Ersatzdichtungen
für Außenlichterkette Type 977

8159770590 10

Anwendungshinweis

Bei Produkten der Candle Light Series dürfen LED und normale Glühlampen nicht gemeinsam verwendet werden.

Teilbarer Stecker – Ringleitung (Loop)

Lichterketten der Candle Light Series sind mit einem teilbaren Stecker (trennbare Steckvorrichtung) ausgestattet, der das Schmücken eines Baumes sehr vereinfacht.

Man beginnt mit der mittleren Brennstelle einer Lichterkette im oberen Bereich des zu schmückenden Baumes und arbeitet sich nach unten weiter, abschließend fügt man den teilbaren Stecker zusammen und verbindet diesen mit dem Stromnetz.

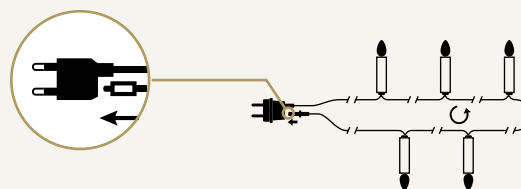

austauschbare
Toplampen



austauschbare
Schaftlampen

MK ILLUMINATION
PRODUCTS

LIGHT GREENERY



Brookfield Place – Canada





Light Greenery

Die Light Greenery Familie beinhaltet naturgetreue Grünbäume, Grüngirlanden und Kränze mit der dazugehörigen Dekoration sowie unsere klassischen weihnachtlichen Elemente. Die Produkte können auf unterschiedliche Art und Weise geschmückt werden, von der Lichtbestückung bis hin zu winterlich weißer Beflockung und individuell konzeptionierter Dekoration. Innovative Folienschnitte und Stanzformen lassen außerdem farbliche und optische Gestaltungsmöglichkeiten von Bäumen, Girlanden und Kränzen zu.



- // Schutzart IP67 / Indoor IP20
- // ideal für kreative Ideen
- // einfache Handhabung
- // Tagwirkung
- // SELV (Schutzkleinspannung)
für Handbereich



EXCLUSIVE TREE
NATURAL BRANCH

Wählen Sie das
Material Ihres Baumes:



Natural Branch

- // natürliche Form
- // 3 Folien-Farben
- // Outdoor
- // Indoor



Stamping Foil

- // verschiedene Shapes
- // verschiedene Farben
- // matt-glänzend
- // Indoor
- // Outdoor: auf Anfrage!



Fibre Branch

- // natürlich, borstig
- // hellere Spitzen
- // Outdoor
- // Indoor



Flocked Branch

- // Beflockung variabel
- // leicht – ganz beflockt
- // Indoor

Wählen Sie Ihre passende Dekorationsvariante:



Basic



Standard



Premium



Dekorationen und Weihnachtskugeln sind auf Anfrage möglich.
Dekorierte Bäume bzw. Girlanden mit Weihnachtskugeln sind nur für den Innenbereich geeignet.



Deco Baubles

QuickFix™ Tree

- Tinsel Tipps
 - Inkl. stabilen Standbein, optional: Golden Pot
 - sehr geringe bis keine Bodenfreiheit
 - Äste mit der "hinged on" Technik befestigt
 - koppelbar
 - Tree Wraps für die Lagerung
-
- B1 geprüfte Qualität
 - Hohe Anzahl an Tipps – sehr dichte Verarbeitung
 - Jede einzelne Lampe ist immer an einem Tipp befestigt
 - Kabel im Inneren des Produktes verarbeitet
 - Natürliche Farbe der Tipps, daher ein sehr natürliches Aussehen
 - Variable Lichtbestückung
 - optimale Transportverpackung
 - kostengünstige Lagerung



OVERVIEW

Christmas Tree



- // koppelbar
- // inkl. grünem Plastik Standfuß
- // inkl. Netzteil SELV
- // ohne Netzstecker



Exclusive

Ø:	1.45 m	1.55 m	1.65 m
Höhe:	1.80 m	2.10 m	2.40 m
LED:	600	720	960



- // natürliche Form
- // sehr dichte Verarbeitung
- // opulentes Erscheinungsbild
- // unregelmäßige Kontur



Classic

Ø:	1.16 m	1.26 m	1.46 m
Höhe:	1.80 m	2.10 m	2.40 m
LED:	800	1200	1600



- // konzentrierte Lichtwirkung
- // hohe Anzahl an Tipps
- // schlankes Erscheinungsbild



Modern

Ø:	1.02 m	1.18 m	1.46 m
Höhe:	1.80 m	2.10 m	2.40 m
LED:	680	1000	1280



- // weniger Tipps als Classic
- // spitze und gerade Form
- // konzentrierte Lichtwirkung
- // schlankes Erscheinungsbild



Slim Line

Ø:	1.10 m	1.20 m	1.40 m
Höhe:	1.80 m	2.10 m	2.40 m
LED:	680	1000	1280



- // graziöses Erscheinungsbild
- // natürliche Form
- // platzsparend



Slim Line Silhouette

Ø:	0.70 m	0.80 m	0.90 m
Höhe:	1.80 m	2.10 m	2.40 m
LED:	320	360	480



- // auch für Dekovasen in 1.10 m erhältlich
- // spitze und gerade Form
- // platzsparend





LIGHT GREENERY

Allee Center Leipzig – Germany

Christmas Tree Exclusive

1.8 m / 2.1 m / 2.4 m



QuickFix™ Low Voltage+
36 V | 21.5 W

Exklusiv 1.8 m



290-092



Dimension: Ø 1.45 m x 1.8 m
Tipps: 1136, inkl. 029-088
inkl. 1 x 002-010
LED: 600

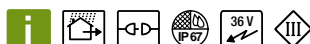

QuickFix™ Low Voltage+
36 V | 25.8 W

Exklusiv 2.1 m



290-093



Dimension: Ø 1.55 m x 2.1 m
Tipps: 1682, inkl. 029-088
inkl. 1 x 002-010
LED: 720

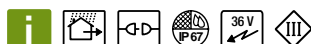

QuickFix™ Low Voltage+
36 V | 34.4 W

Exklusiv 2.4 m



290-094



Dimension: Ø 1.65 m x 2.4 m
Tipps: 2036, inkl. 029-088
inkl. 1 x 002-010
LED: 960

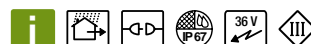

Christmas Tree Classic

1.8 m / 2.1 m / 2.4 m



QuickFix™ Low Voltage+
36 V | 28.7 W

Classic 1.8 m



290-942



Dimension: Ø 1.16 m x 1.8 m
Tipps: 1186, inkl. 029-088
inkl. 1 x 002-010
LED: 800



QuickFix™ Low Voltage+
36 V | 43 W

Classic 2.1 m



290-943



Dimension: Ø 1.26 m x 2.1 m
Tipps: 1600, inkl. 029-088
inkl. 1 x 002-018
LED: 1200



QuickFix™ Low Voltage+
36 V | 57.4 W

Classic 2.4 m



290-944



Dimension: Ø 1.46 m x 2.4 m
Tipps: 1918, inkl. 029-088
inkl. 1 x 002-018
LED: 1600



Christmas Tree Modern

1.8 m / 2.1 m / 2.4 m



QuickFix™ Low Voltage+
36 V | 24.5 W

Modern 1.8 m



290-946



Dimension: Ø 1.02 m x 1.8 m
Tipps: 821, inkl. 029-088
inkl. 1 x 002-010
LED: 680

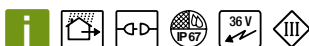

QuickFix™ Low Voltage+
36 V | 35.8 W

Modern 2.1 m



290-947



Dimension: Ø 1.18 m x 2.1 m
Tipps: 1219, inkl. 029-088
inkl. 1 x 002-018
LED: 1000

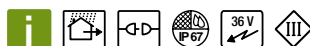

QuickFix™ Low Voltage+
36 V | 45.8 W

Modern 2.4 m



290-948



Dimension: Ø 1.29 m x 2.4 m
Tipps: 1555, inkl. 029-088
inkl. 1 x 002-018
LED: 1280

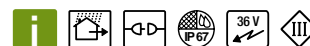

Christmas Tree Slim Line

1.8 m / 2.1 m / 2.4 m



QuickFix™ Low Voltage+
36 V | 24.4 W

Slim Line 1.8 m



290-955



Dimension: Ø 1.1 m x 1.8 m
Tipps: 855, inkl. 029-088
inkl. 1 x 002-010
LED: 680



QuickFix™ Low Voltage+
36 V | 35.8 W

Slim Line 2.1 m



290-956



Dimension: Ø 1.2 m x 2.1 m
Tipps: 1323, inkl. 029-088
inkl. 1 x 002-018
LED: 1000

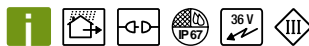

QuickFix™ Low Voltage+
36 V | 45.8 W

Slim Line 2.4 m



290-957



Dimension: Ø 1.4 m x 2.4 m
Tipps: 1875, inkl. 029-088
inkl. 1 x 002-018
LED: 1280

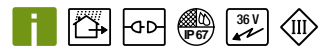

Christmas Tree Slim Line Silhouette

1.8 m / 2.1 m / 2.4 m



QuickFix™ Low Voltage+
36 V | 11.5 W

Slim Line Silhouette 1.8 m



290-638



— siehe Seite 132 —

Dimension: Ø 0.7 m x 1.8 m
Tipps: 439, inkl. 029-088
inkl. 1 x 002-009
LED: 320

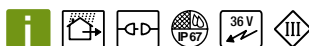

QuickFix™ Low Voltage+
36 V | 12.9 W

Slim Line Silhouette 2.1 m



290-639



— siehe Seite 132 —

Dimension: Ø 0.8 m x 2.1 m
Tipps: 643, inkl. 029-088
inkl. 1 x 002-009
LED: 360

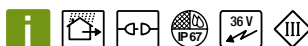

QuickFix™ Low Voltage+
36 V | 17.2 W

Slim Line Silhouette 2.4 m



290-640



— siehe Seite 132 —

Dimension: Ø 0.9 m x 2.4 m
Tipps: 883, inkl. 029-088
inkl. 1 x 002-009
LED: 480

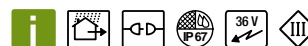



LIGHT GREENERY

Schultheiss Quartier, Berlin – Germany

Giant Christmas



mit Lichterkette für den Innen- und Aussenbereich mit Netzteil SELV

- Lieferung mit Netzstecker (EU)
- Abweichende Höhen auf Anfrage
- Beschwerungsgewichte bzw. Abspannungsmaterial optional erhältlich

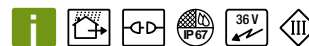

- // variable Bestückung (Farben / Indoor / Outdoor)
- // Höhenverstellbar bzw. erweiterbar
- // sehr dichte Verarbeitung
- // professionelle Lichteinarbeitung
- // schneller, einfacher Auf- und Abbau
- // Stahlkonstruktion
- // B1 geprüfte Qualität

i Weitere Infos unter: www.mk-illumination.com



QuickFix™ Low Voltage+
36 V

Giant Christmas 4 m | 60.5 W

LED 290-811

Dimension: Ø 1.6 m x 4 m
LED: 1.680, 74 kg
Tipps: 638, inkl. 029-019
inkl. 1 x 002-018

Giant Christmas 6 m | 140 W

LED 290-812

Dimension: Ø 2.4 m x 6 m
LED: 3.900, 206 kg
Tipps: 732, inkl. 029-019
inkl. 1 x 002-013

Giant Christmas 7 m | 196 W

LED 290-813

Dimension: Ø 2.8 m x 7 m
LED: 5.460, 278 kg
Tipps: 779, inkl. 029-019
inkl. 2 x 002-012

Giant Christmas 9 m | 342 W

LED 290-814

Dimension: Ø 3.6 m x 9 m
LED: 9.540, 495 kg
Tipps: 873, inkl. 029-019
inkl. 2 x 002-012, 1 x 002-013

Giant Christmas 11 m | 525 W

LED 290-815

Dimension: Ø 4.4 m x 11 m
LED: 14.640, 767 kg
Tipps: 967, inkl. 029-019
inkl. 2 x 002-012, 2 x 002-013



Woonmall Alexandrium, Rotterdam – Netherlands



Marstall Center, Ludwigsburg – Germany



Emsgalerie, Rheine – Germany



LIGHT GREENERY

Noventa di Piave, Venice – Italia

Giant Skyline



- Abweichende Höhen auf Anfrage
- Beschwerungsgewichte bzw. Abspannungsmaterial optional erhältlich

- // variable Bestückung
- // Höhenverstellbar bzw. erweiterbar
- // sehr dichte Verarbeitung
- // professionelle Lichteinarbeitung
- // schneller, einfacher Auf- und Abbau
- // Stahlkonstruktion
- // B1 geprüfte Qualität
- // optimierte Konstruktion für Transport und Lagerung

 Weitere Infos unter: www.mk-illumination.com



QuickFix™ Outdoor+
Rubber 230 V

Giant Skyline – 15 m | 1680 W



190-807

Dimension: Ø 5.8 m x 15 m
LED: 28.500, 1.560 kg
Tipps: 81.259, inkl. 019-310
inkl. Trenntrafo

Giant Skyline – 17 m | 2200 W



190-808

Dimension: Ø 6.6 m x 17 m
LED: 37.200, 2.093 kg
Tipps: 106.199, inkl. 019-310
inkl. Trenntrafo

Giant Skyline – 31 m | 7600 W



190-811

Dimension: Ø 12.2 m x 31 m
LED: 129.240, 8.176 kg
Tipps: 370.219, inkl. 019-310
inkl. Trenntrafo





LIGHT GREENERY

Akropolis, Kaunas –Lithuania



mit Lichterkette für den Innen- und Aussenbereich mit Netzteil SELV

- Lieferung mit Netzstecker (EU)
- Abweichende Höhen auf Anfrage
- Beschwerungsgewichte bzw. Abspannungsmaterial optional erhältlich

Giant Natural

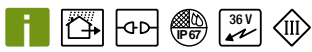

- // variable Bestückung (Farben / Indoor / Outdoor)
- // Höhenverstellbar bzw. erweiterbar
- // sehr dichte Verarbeitung
- // professionelle Lichteinarbeitung
- // schneller, einfacher Auf- und Abbau
- // Stahlkonstruktion
- // B1 geprüfte Qualität
- // natürliche Form

i Weitere Infos unter: www.mk-illumination.com



QuickFix™ Low Voltage+
36 V

Giant Natural – 5.8 m | 126 W

LED 290-132

Dimension: Ø 2.9 m x 5.8 m
LED: 3.480, 612 kg
Tipps: 1.897, inkl. 029-088
inkl. 1 x 002-018, 1 x 002-012

Giant Natural – 7.8 m | 247 W

LED 290-133

Dimension: Ø 3.7 m x 7.8 m
LED: 6.840, 720 kg
Tipps: 3.661, inkl. 029-088
inkl. 3 x 002-018, 1 x 002-012

Giant Natural – 9.8 m | 414 W

LED 290-134

Dimension: Ø 4.4 m x 9.8 m
LED: 11.480, 850 kg
Tipps: 6.097, inkl. 029-088
inkl. 3 x 002-018, 3 x 002-012

Giant Natural – 10.8 m | 515 W

LED 290-114

Dimension: Ø 4.9 m x 10.8 m
LED: 14.280, 1.000 kg
Tipps: 7.567, inkl. 029-088
inkl. 3 x 002-018, 3 x 002-012

Giant Natural – 11.8 m | 627 W

LED 290-115

Dimension: Ø 5.3 m x 11.8 m
LED: 17.400, 1.241 kg
Tipps: 9.205, inkl. 029-088
inkl. 3 x 002-018, 4 x 002-012

Giant Natural – 12.8 m | 751 W

LED 290-116

Dimension: Ø 5.7 m x 12.8 m
LED: 20.840, 1.446 kg
Tipps: 11.011, inkl. 029-088
inkl. 3 x 002-018, 5 x 002-012, 1 x 002-013



Akropolis, Kaunas – Lithuania



Swarowski, Wattens – Austria



McArthurGlen Athens – Greece

Wählen Sie das
Material Ihrer Girlande:



SIMPLE GARLAND
NATURAL BRANCH



SWAG GARLAND
NATURAL BRANCH



Natural Branch

// natürliche Form
// 3 Folien-Farben
// Outdoor
// Indoor



Stamping Foil

// verschiedene Shapes
// verschiedene Farben
// matt-glänzend
// Indoor
// Outdoor: auf Anfrage!



Fibre Branch

// natürlich, borstig
// hellere Spitzen
// Outdoor
// Indoor



Flocked Branch

// Beflockung variabel
// leicht – ganz beflockt
// Indoor

Wählen Sie Ihre passende
Ausführung:

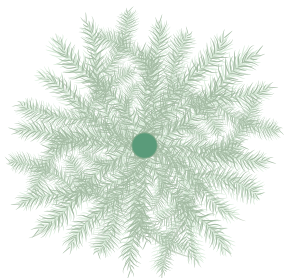

Complete Garland

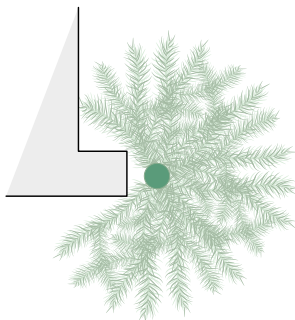

3/4 Garland

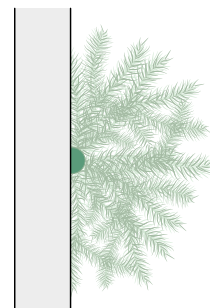

1/2 Garland



Dekorationen und Weihnachtskugeln sind auf Anfrage möglich.
Dekorierte Bäume bzw. Girlanden mit Weihnachtskugeln sind nur für den Innenbereich geeignet.

QuickFix™ Simple Garland / Swag Garland

- Variabel auf verstärktem Stahldraht oder auf pulverbeschichteter Metallstange gebunden
- direkt aus dem Karton aufhängen – ohne großen Aufwand
- Verpackung: Kartons haben Palettenmaße. 4-5 Kartons stapelbar / Palette
- koppel- und erweiterbar

- B1 geprüfte Qualität
- Hohe Anzahl an Tipps – sehr dichte Verarbeitung
- Jede einzelne Lampe ist immer an einem Tipp befestigt
- Kabel im Inneren des Produktes verarbeitet
- Natürliche Farbe der Tipps, daher ein sehr natürliches Aussehen
- Variable Lichtbestückung
- optimale Transportverpackung
- kostengünstige Lagerung





LIGHT GREENERY

Stockholm – Sweden

Simple Garland

- // variable Bestückung (Farben / 36V / Indoor / Outdoor)
- // sehr dichte Verarbeitung
- // professionelle Lichteinrichtung
- // schneller, einfacher Auf- und Abbau
- // B1 geprüfte Qualität



 Weitere Infos unter: www.mk-illumination.com



QuickFix™ Outdoor+ 230 V

Simple Garland

LED 190-485



Dimension: Ø 0.3 m x 2 m
LED: 240
220-240 V, 14 W, 6.2 kg
Tipps: 266, inkl. 019-310

LED 190-486



Dimension: Ø 0.4 m x 2 m
LED: 360
220-240 V, 21 W, 9.1 kg
Tipps: 400, inkl. 019-310



QuickFix™ Indoor 230 V

Simple Garland

LED 170-046



Dimension: Ø 0.3 m x 2 m
LED: 240
220-240 V, 14 W, 7.1 kg
Tipps: 266, inkl. 017-043

LED 170-047



Dimension: Ø 0.4 m x 2 m
LED: 360
220-240 V, 21 W, 9.4 kg
Tipps: 400, inkl. 017-043



QuickFix™ Low Voltage+ 36 V

Simple Garland

LED 290-174



Dimension: Ø 0.3 m x 2 m
LED: 240
36 V, 8.6 W, 7.2 kg
Tipps: 266, inkl. 029-169

LED 290-175



Dimension: Ø 0.4 m x 2 m
LED: 360
36 V, 12.9 W, 8 kg
Tipps: 400, inkl. 029-169

3/4 Simple Garland

LED 290-176



Dimension: Ø 0.3 m x 2 m
LED: 180
36 V, 6.5 W, 6.8 kg
Tipps: 200, inkl. 029-169



integrierter
Stahldraht mit
Kabelkautschu



integrierte
Metallstange +
QuickFix™ Anschluss



gesicherte
Steckverbindung

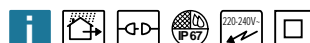

- // koppelbar
- // auf verstärktem Stahldraht gebunden
- // optimale Transportverpackung
- // ohne Netzstecker

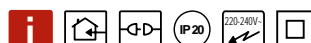

- // koppelbar
- // integrierte Metallstange
- // optimale Transportverpackung
- // ohne Netzstecker

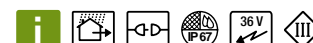

- // koppelbar
- // integrierte Metallstange
- // optimale Transportverpackung
- // integriertes Verlängerungskabel
- // ohne Netzteil (SELV)

Swag Garland



QuickFix™ Outdoor+
230 V

Swag Garland – 2.7 m

LED 190-490



Dimension: Ø 0.14-0.45 m x 2.7 m
LED: 360
220-240 V, 21 W, 9.75 kg
Tipps: 618, inkl. 019-310

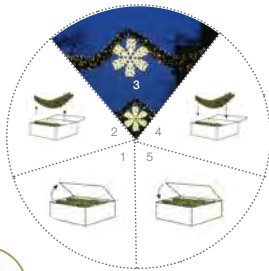

- // koppelbar
- // auf verstärktem Stahldraht gebunden
- // optimale Transportverpackung
- // ohne Netzstecker



Beverhof – Netherlands



QuickFix™ Indoor
230 V

Swag Garland - 2.7 m

LED 170-489



Dimension: Ø 0.14-0.45 m x 2.7 m
LED: 360
220-240 V, 21 W, 8.6 kg
Tipps: 618, inkl. 017-043

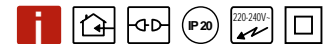

- // koppelbar
- // auf verstärktem Stahldraht gebunden
- // optimale Transportverpackung
- // ohne Netzstecker



Jönköping – Sweden

Wreath & Balls



QuickFix™ Indoor
230 V

Wreath



170-344



siehe Seite 124

Dimension: Ø 75cm

LED: 200
220-240 V, 17.5 W, 3.25 kg
Tipps: 396, inkl. 017-041



170-345



siehe Seite 124

Dimension: Ø 100cm

LED: 320
220-240 V, 28 W, 5.5 kg
Tipps: 528, inkl. 017-041

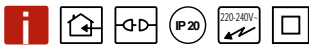

// ohne Netzstecker



170-346



siehe Seite 124

Dimension: Ø 150cm

LED: 720
220-240 V, 63 W, 21 kg
Tipps: 1572, inkl. 017-041



170-181



siehe Seite 124

Dimension: Ø 200cm

LED: 2880
220-240 V, 252 W, 84 kg
Tipps: 6480, inkl. 017-041
3D Stahlkonstruktion



QuickFix™ Indoor
230 V

Ball



170-348



siehe Seite 124

Dimension: Ø 50cm

LED: 240
220-240 V, 21 W, 4.75 kg
inkl. 017-041



170-349



siehe Seite 124

Dimension: Ø 80cm

LED: 480
220-240 V, 42 W, 13.5 kg
inkl. 017-041



Stadt-Galerie Plauen – Germany



Ingelsta shopping, Norrköping – Sweden

Weitere Infos unter: www.mk-illumination.com

LIGHT GREENERY *accessories*



LED QuickFix™ Main Connector

	EU	UK	CH	AU
	001-011	001-013	001-015	001-017



Anschluss: Zuleitung an LED QuickFix™ mit Gleichrichter, max. Belastbarkeit: 480 W (220C)



siehe Seite 124



QuickFix™ 3+ Main Connector

	EU	UK	CH	AU
	003-001	003-003	003-005	003-007

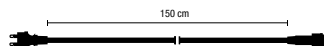

Anschluss: Zuleitung an QuickFix™ max. Belastbarkeit: 1800 W (820C)



siehe Seite 134



LED QuickFix™ Main Connector

	EU	UK	CH	AU
	007-012	007-014	007-016	007-018
	007-011			

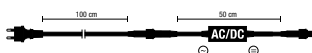

Anschluss: Zuleitung an LED QuickFix™ mit Gleichrichter, max. Belastbarkeit: 480 W (220C)



siehe Seite 124



QuickFix™ Low Voltage+ Power Supply

► siehe Seite 135



Golden Pot 50

015-142
 Ø 50 cm, Höhe: 16 cm
 für Bäume: 2.10 - 2.40 m



Golden Pot 40

015-143
 Ø 40 cm, Höhe: 16 cm
 für Bäume: 1,8 m



035-327 mit Rollen

Ø 50 cm, Höhe: 20 cm
 für Bäume: 2.10 - 2.40 m



Tree Wrap

015-146
 Transport- und
 Lagerhülle
 für Bäume bis 2.5 m
 mit Reißverschluss



MK ILLUMINATION
PRODUCTS

LIGHT MOTIFS



Bremerhaven – Germany



Kitzbühel – Austria



Lighting Motifs

Unsere beliebten Standard-Lichtmotive lassen sich ganz individuell und flexibel miteinander kombinieren. Sie eignen sich besonders gut für festliche Inszenierungen von Bäumen, Fassaden und ganzen Gebäuden. Ihre Montage ist durch unser MK eigenes QuickFix™ System – das alle Produkte leicht miteinander koppelbar macht – besonders einfach zu bewerkstelligen.

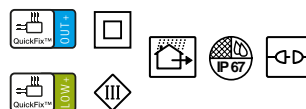

i

- // QuickFix™ kompatibel
- // Schutzart IP67
- // ohne Netzstecker
- // Schutzklasse 2 (QF Outdoor+)
- // Schutzklasse 3 (QF Low Voltage+)
- // ohne AC/DC (QF Outdoor+)
- // Power Supply erforderlich (QF Low Voltage+)
- // Controller erforderlich (RGB-Motive)



Lingen – Germany

LIGHT MOTIFS

Organic 3D

Traditional



① Organic Bell

② Organic Tree

③ Organic Nut

NEW

- ① Organic Bell
- 150-005 / ~ 66 x 88 x 26 cm / ~ 4 kg / ~ 7 W / 230 V /  LED / ☆ T-1  / 2 parts / **3.75** € **8** .U.
 - 150-505 / ~ 66 x 88 x 26 cm / ~ 4 kg / ~ 3 W / 36 V /  LED / ☆ T-1  / 2 parts / **3.5** € **20** .U.
 - 150-006 / ~ 90 x 115 x 28 cm / ~ 5.5 kg / ~ 11 W / 230 V /  LED / ☆ T-1  / 2 parts / **5.5** € **12** .U.
 - 150-506 / ~ 90 x 115 x 28 cm / ~ 5.5 kg / ~ 4.5 W / 36 V /  LED / ☆ T-1  / 2 parts / **5** € **30** .U.
- ② Organic Tree
- 150-007 / ~ 64 x 78 x 36 cm / ~ 4 kg / ~ 7 W / 230 V /  LED / ☆ T-1  / 2 parts / **3.5** € **8** .U.
 - 150-507 / ~ 64 x 78 x 36 cm / ~ 4 kg / ~ 3 W / 36 V /  LED / ☆ T-1  / 2 parts / **3.5** € **20** .U.
 - 150-008 / ~ 78 x 102 x 38 cm / ~ 6 kg / ~ 14 W / 230 V /  LED / ☆ T-1  / 2 parts / **7.5** € **16** .U.
 - 150-508 / ~ 78 x 102 x 38 cm / ~ 6 kg / ~ 6 W / 36 V /  LED / ☆ T-1  / 2 parts / **6.75** € **40** .U.
- ③ Organic Nut
- 150-159 / ~ 44 x 75 x 44 cm / ~ 3,9 kg / ~ 3,9 W / 230 V /  LED / ☆ T-1  / 2 parts / **3.75** € **8** .U.
 - 150-759 / ~ 44 x 75 x 44 cm / ~ 3,9 kg / ~ 1,8 W / 36 V /  LED / ☆ T-1  / 2 parts / **3.5** € **20** .U.
 - 150-160 / ~ 55 x 96 x 55 cm / ~ 5,2 kg / ~ 14 W / 230 V /  LED / ☆ T-1  / 2 parts / **7.5** € **16** .U.
 - 150-760 / ~ 55 x 96 x 55 cm / ~ 5,2 kg / ~ 6 W / 36 V /  LED / ☆ T-1  / 2 parts / **6.75** € **40** .U.



















LIGHT MOTIFS

Organic 3D Stars



① Organic Star

① Organic Star

- 150-001 / ~ 60 x 60 x 20 cm / ~ 3 kg / ~ 7 W / 230 V /  LED / ☆ T-1 3D / 2 parts / **3.75** C- **8** .U.
- 150-501 / ~ 60 x 60 x 20 cm / ~ 3 kg / ~ 3 W / 36 V /  LED / ☆ T-1 3D / 2 parts / **3.5** C- **20** .U.
- 150-002 / ~ 102 x 102 x 36 cm / ~ 4 kg / ~ 14 W / 230 V /  LED / ☆ T-1 3D / 2 parts / **7.5** C- **16** .U.
- 150-502 / ~ 102 x 102 x 36 cm / ~ 4 kg / ~ 6 W / 36 V /  LED / ☆ T-1 3D / 2 parts / **6.75** C- **40** .U.
- 150-003 / ~ 130 x 130 x 46 cm / ~ 6.4 kg / ~ 21 W / 230 V /  LED / ☆ T-1 3D / 2 parts / **7.5** C- **16** .U.
- 150-503 / ~ 130 x 130 x 46 cm / ~ 5.6 kg / ~ 9 W / 36 V /  LED / ☆ T-1 3D / 2 parts / **6.75** C- **40** .U.
- 150-004 / ~ 150 x 150 x 53 cm / ~ 9 kg / ~ 28 W / 230 V /  LED / ☆ T-1 3D / 2 parts / **7.5** C- **16** .U.
- 150-504 / ~ 150 x 150 x 53 cm / ~ 7.8 kg / ~ 7.5 W / 36 V /  LED / ☆ T-1 3D / 2 parts / **6.75** C- **40** .U.
- 150-154 / ~ 60 x 60 x 20 cm / ~ 3 kg / ~ 7 W / 230 V /  LED / ☆ T-1 3D / 2 parts / **3.75** C- **8** .U.
- 150-754 / ~ 60 x 60 x 20 cm / ~ 3 kg / ~ 3 W / 36 V /  LED / ☆ T-1 3D / 2 parts / **3.5** C- **20** .U.
- 150-155 / ~ 102 x 102 x 36 cm / ~ 4 kg / ~ 14 W / 230 V /  LED / ☆ T-1 3D / 2 parts / **7.5** C- **16** .U.
- 150-755 / ~ 102 x 102 x 36 cm / ~ 4 kg / ~ 6 W / 36 V /  LED / ☆ T-1 3D / 2 parts / **6.75** C- **40** .U.
- 150-156 / ~ 130 x 130 x 46 cm / ~ 6.4 kg / ~ 21 W / 230 V /  LED / ☆ T-1 3D / 2 parts / **7.5** C- **16** .U.
- 150-756 / ~ 130 x 130 x 46 cm / ~ 5.6 kg / ~ 9 W / 36 V /  LED / ☆ T-1 3D / 2 parts / **6.75** C- **40** .U.
- 150-157 / ~ 150 x 150 x 53 cm / ~ 9 kg / ~ 28 W / 230 V /  LED / ☆ T-1 3D / 2 parts / **7.5** C- **16** .U.
- 150-757 / ~ 150 x 150 x 53 cm / ~ 7.8 kg / ~ 7.5 W / 36 V /  LED / ☆ T-1 3D / 2 parts / **6.75** C- **40** .U.



① Organic Starlet

② Organic Shooting Star

① Organic Starlet

- 150-039 / ~ Ø 38 cm / ~ 0.7 kg / ~ 7 W / 230 V / LED / ☆ T-1 / 3.5 G 4 .U.
- 150-539 / ~ Ø 38 cm / ~ 0.7 kg / ~ 3 W / 36 V / LED / ☆ T-1 / 3.25 G 10 .U.
- 150-040 / ~ Ø 67 cm / ~ 1.8 kg / ~ 14 W / 230 V / LED / ☆ T-1 / 7 G 8 .U.
- 150-540 / ~ Ø 67 cm / ~ 1.8 kg / ~ 6 W / 36 V / LED / ☆ T-1 / 6.5 G 20 .U.
- 150-041 / ~ Ø 95 cm / ~ 2.5 kg / ~ 14 W / 230 V / LED / ☆ T-1 / 7 G 8 .U.
- 150-541 / ~ Ø 95 cm / ~ 2.5 kg / ~ 6 W / 36 V / LED / ☆ T-1 / 6.5 G 20 .U.
- 150-043 / ~ Ø 38 cm / ~ 0.7 kg / ~ 7 W / 230 V / LED / ☆ T-1 / 3.5 G 4 .U.
- 150-543 / ~ Ø 38 cm / ~ 0.7 kg / ~ 3 W / 36 V / LED / ☆ T-1 / 3.25 G 10 .U.
- 150-044 / ~ Ø 67 cm / ~ 1.8 kg / ~ 14 W / 230 V / LED / ☆ T-1 / 7 G 8 .U.
- 150-544 / ~ Ø 67 cm / ~ 1.8 kg / ~ 6 W / 36 V / LED / ☆ T-1 / 6.5 G 20 .U.
- 150-045 / ~ Ø 95 cm / ~ 2.5 kg / ~ 14 W / 230 V / LED / ☆ T-1 / 7 G 8 .U.
- 150-545 / ~ Ø 95 cm / ~ 2.5 kg / ~ 6 W / 36 V / LED / ☆ T-1 / 6.5 G 20 .U.

② Organic Shooting Star

- 150-042 / ~ 91 x 46 cm / ~ 2.2 kg / ~ 14 W / 230 V / LED / ☆ T-1 / 7 G 8 .U.
- 150-542 / ~ 91 x 46 cm / ~ 2.2 kg / ~ 6 W / 36 V / LED / ☆ T-1 / 6.5 G 20 .U.
- 150-046 / ~ 91 x 46 cm / ~ 2.2 kg / ~ 14 W / 230 V / LED / ☆ T-1 / 7 G 8 .U.
- 150-546 / ~ 91 x 46 cm / ~ 2.2 kg / ~ 6 W / 36 V / LED / ☆ T-1 / 6.5 G 20 .U.

Organic 2D
Stars



③ Organic Star Eclipse



④ Organic Star Dust

- ① Organic Star Eclipse 150-035 / ~ Ø 91 cm / ~ 2.4 kg / ~ 14 W / 230 V /  LED / ☆ T-1 /  7 W  8 U
 150-535 / ~ Ø 91 cm / ~ 2.4 kg / ~ 6 W / 36 V /  LED / ☆ T-1 /  6.5 W  20 U
 150-036 / ~ Ø 91 cm / ~ 2.4 kg / ~ 14 W / 230 V /  LED / ☆ T-1 /  7 W  8 U
 150-536 / ~ Ø 91 cm / ~ 2.4 kg / ~ 6 W / 36 V /  LED / ☆ T-1 /  6.5 W  20 U
- ② Organic Star Dust 150-037 / ~ Ø 69 cm / ~ 2.1 kg / ~ 7 W / 230 V /  LED / ☆ T-1 /  3.5 W  4 U
 150-537 / ~ Ø 69 cm / ~ 2.1 kg / ~ 3 W / 36 V /  LED / ☆ T-1 /  3.25 W  10 U
 150-038 / ~ Ø 69 cm / ~ 2.1 kg / ~ 7 W / 230 V /  LED / ☆ T-1 /  3.5 W  4 U
 150-538 / ~ Ø 69 cm / ~ 2.1 kg / ~ 3 W / 36 V /  LED / ☆ T-1 /  3.25 W  10 U







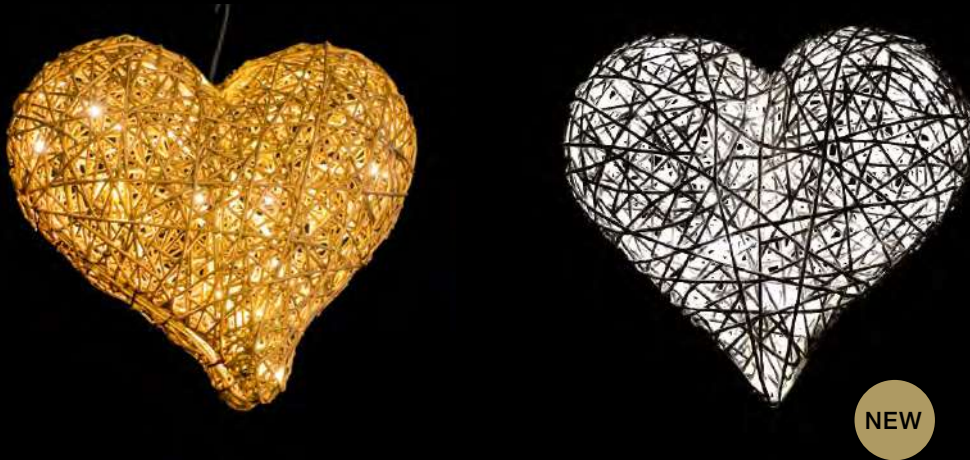











Helsinki - Finland

Organic 3D
Hearts



① Organic Heart

① Organic Heart

- 150-021 / ~ 62 x 60 x 33 cm / ~ 3 kg / ~ 7 W / 230 V /  LED / ☆ T-1  / 2 parts / **3.75** € **8** .U.
- 150-521 / ~ 62 x 60 x 33 cm / ~ 3 kg / ~ 3 W / 36 V /  LED / ☆ T-1  / 2 parts / **3.5** € **20** .U.
- 150-022 / ~ 82 x 78 x 33 cm / ~ 4.5 kg / ~ 14 W / 230 V /  LED / ☆ T-1  / 2 parts / **5.5** € **12** .U.
- 150-522 / ~ 82 x 78 x 33 cm / ~ 4.5 kg / ~ 4.5 W / 36 V /  LED / ☆ T-1  / 2 parts / **5** € **30** .U.
- 150-023 / ~ 62 x 60 x 33 cm / ~ 3 kg / ~ 7 W / 230 V /  LED / ☆ T-1  / 1 part / **7** € **8** .U.
- 150-523 / ~ 62 x 60 x 33 cm / ~ 3 kg / ~ 3 W / 36 V /  LED / ☆ T-1  / 1 part / **6.75** € **40** .U.
- 150-024 / ~ 82 x 78 x 33 cm / ~ 4.5 kg / ~ 14 W / 230 V /  LED / ☆ T-1  / 2 parts / **5.5** € **12** .U.
- 150-524 / ~ 82 x 78 x 33 cm / ~ 4.5 kg / ~ 4.5 W / 36 V /  LED / ☆ T-1  / 2 parts / **5** € **30** .U.
- 150-152 / ~ 62 x 60 x 33 cm / ~ 3 kg / ~ 7 W / 230 V /  LED / ☆ T-1  / 1 part / **7** € **8** .U.
- 150-752 / ~ 62 x 60 x 33 cm / ~ 3 kg / ~ 3 W / 36 V /  LED / ☆ T-1  / 1 part / **6.75** € **40** .U.
- 150-153 / ~ 82 x 78 x 33 cm / ~ 4.5 kg / ~ 14 W / 230 V /  LED / ☆ T-1  / 2 parts / **5.5** € **12** .U.
- 150-753 / ~ 82 x 78 x 33 cm / ~ 4.5 kg / ~ 4.5 W / 36 V /  LED / ☆ T-1  / 2 parts / **5** € **30** .U.



① Organic Heart 2D

② Organic Sweet Heart 2D

① Organic Heart

- 150-027 / ~ 28 x 31 cm / ~ 0.7 kg / ~ 7 W / 230 V / ■ LED / ☆ T-1 / 3.5 C 4 .U
- 150-527 / ~ 28 x 31 cm / ~ 0.7 kg / ~ 3 W / 36 V / ■ LED / ☆ T-1 / 3.25 C 10 .U
- 150-028 / ~ 70 x 74 cm / ~ 2.3 kg / ~ 14 W / 230 V / ■ LED / ☆ T-1 / 7 C 8 .U
- 150-528 / ~ 70 x 74 cm / ~ 2.3 kg / ~ 6 W / 36 V / ■ LED / ☆ T-1 / 6.5 C 20 .U
- 150-029 / ~ 85 x 92 cm / ~ 3.5 kg / ~ 14 W / 230 V / ■ LED / ☆ T-1 / 7 C 8 .U
- 150-529 / ~ 85 x 92 cm / ~ 3.5 kg / ~ 6 W / 36 V / ■ LED / ☆ T-1 / 6.5 C 20 .U
- 150-031 / ~ 28 x 31 cm / ~ 0.7 kg / ~ 7 W / 230 V / ■ LED / ☆ T-1 / 3.5 C 4 .U
- 150-531 / ~ 28 x 31 cm / ~ 0.7 kg / ~ 3 W / 36 V / ■ LED / ☆ T-1 / 3.25 C 10 .U
- 150-032 / ~ 70 x 74 cm / ~ 2.3 kg / ~ 14 W / 230 V / ■ LED / ☆ T-1 / 7 C 8 .U
- 150-532 / ~ 70 x 74 cm / ~ 2.3 kg / ~ 6 W / 36 V / ■ LED / ☆ T-1 / 6.5 C 20 .U
- 150-033 / ~ 85 x 92 cm / ~ 3.5 kg / ~ 14 W / 230 V / ■ LED / ☆ T-1 / 7 C 8 .U
- 150-533 / ~ 85 x 92 cm / ~ 3.5 kg / ~ 6 W / 36 V / ■ LED / ☆ T-1 / 6.5 C 20 .U

② Organic Sweet Heart

- 150-030 / ~ 86 x 92 cm / ~ 2.3 kg / ~ 14 W / 230 V / ■ LED / ☆ T-1 / 7 C 8 .U
- 150-530 / ~ 86 x 92 cm / ~ 2.3 kg / ~ 6 W / 36 V / ■ LED / ☆ T-1 / 6.5 C 20 .U
- 150-034 / ~ 86 x 92 cm / ~ 2.3 kg / ~ 14 W / 230 V / ■ LED / ☆ T-1 / 7 C 8 .U
- 150-534 / ~ 86 x 92 cm / ~ 2.3 kg / ~ 6 W / 36 V / ■ LED / ☆ T-1 / 6.5 C 20 .U

















Organic 2D/3D
Hearts



② Organic Heart 2 / 3D



③ Organic Heart small / 3D

- ② Organic Heart 2 150-025 / ~ 100 x 86 x 27 cm / ~ 6 kg / ~ 14 W / 230 V /  / ☆ T-1  / 1 part /  
- 150-525 / ~ 100 x 86 x 27 cm / ~ 6 kg / ~ 6 W / 36 V /  / ☆ T-1  / 1 part /  
- ③ Organic Heart small 150-026 / ~ 37 x 35 x 26 cm / ~ 1.5 kg / ~ 3.5 W / 230 V /  / ☆ T-1  / 1 part /  
- 150-526 / ~ 37 x 35 x 26 cm / ~ 1.5 kg / ~ 3 W / 36 V /  / ☆ T-1  / 1 part /  

NEW



① Organic Gift White



② Organic Gift Gold



③ Organic Gift Red

- ① Organic Gift White 150-148 / ~ 40 x 50 x 40 cm / ~ 3 kg / ~ 7 W / 230 V / LED / ☆ T-1 / 1 part / 20 .
 150-748 / ~ 40 x 50 x 40 cm / ~ 3 kg / ~ 3 W / 36 V / LED / ☆ T-1 / 1 part / 30 .
 150-151 / ~ 60 x 70 x 60 cm / ~ 5.8 kg / ~ 11 W / 230 V / LED / ☆ T-1 / 1 part / 20 .
 150-751 / ~ 60 x 70 x 60 cm / ~ 5.8 kg / ~ 4.5 W / 36 V / LED / ☆ T-1 / 1 part / 30 .
- ② Organic Gift Gold 150-149 / ~ 40 x 50 x 40cm / ~ 3 kg / ~ 7 W / 230 V / LED / ☆ T-1 / 1 part / 20 .
 150-749 / ~ 40 x 50 x 40 cm / ~ 3 kg / ~ 3 W / 36 V / LED / ☆ T-1 / 1 part / 30 .
 150-012 / ~ 60 x 70 x 60 cm / ~ 5.8 kg / ~ 11 W / 230 V / LED / ☆ T-1 / 1 part / 20 .
 150-512 / ~ 60 x 70 x 60 cm / ~ 5.8 kg / ~ 4.5 W / 36 V / LED / ☆ T-1 / 1 part / 30 .
- ③ Organic Gift Red 150-150 / ~ 40 x 50 x 40 cm / ~ 3 kg / ~ 7 W / 230 V / LED / ☆ T-1 / 1 part / 20 .
 150-750 / ~ 40 x 50 x 40 cm / ~ 3 kg / ~ 3 W / 36 V / LED / ☆ T-1 / 1 part / 30 .
 150-013 / ~ 60 x 70 x 60 cm / ~ 5.8 kg / ~ 11 W / 230 V / LED / ☆ T-1 / 1 part / 20 .
 150-513 / ~ 60 x 70 x 60 cm / ~ 5.8 kg / ~ 4.5 W / 36 V / LED / ☆ T-1 / 1 part / 30 .

LIGHT MOTIFS

Organic 3D

Christmas



④ Organic Candle 1 ⑤ Organic Candle 2 ⑥ Organic Candle 3 ⑦ Organic Candle 4

- ④ Organic Candle 1 150-014 / ~ 43 x 78 x 43 cm / ~ 3.7 kg / ~ 10.5 W / 230 V / / ☆ T-1 / 1 part /
 150-514 / ~ 43 x 78 x 43 cm / ~ 3.7 kg / ~ 4.5 W / 36 V / / ☆ T-1 / 1 part /
- ⑤ Organic Candle 2 150-015 / ~ 40 x 90 x 40 cm / ~ 3.8 kg / ~ 10.5 W / 230 V / / ☆ T-1 / 1 part /
 150-515 / ~ 40 x 90 x 40 cm / ~ 3.8 kg / ~ 4.5 W / 36 V / / ☆ T-1 / 1 part /
- ⑥ Organic Candle 3 150-016 / ~ 35 x 105 x 35 cm / ~ 4.4 kg / ~ 10.5 W / 230 V / / ☆ T-1 / 1 part /
 150-516 / ~ 35 x 105 x 35 cm / ~ 4.4 kg / ~ 4.5 W / 36 V / / ☆ T-1 / 1 part /
- ⑦ Organic Candle 4 150-158 / ~ 60 x 175 x 60 cm / ~ 18 kg / ~ 21 W / 230 V / / ☆ T-1 / 1 part /
 150-758 / ~ 60 x 175 x 60 cm / ~ 18 kg / ~ 9 W / 36 V / / ☆ T-1 / 1 part /



① Organic Bauble

① Organic Bauble

- 150-142 / ~ 30 x 38 cm / ~ 0.8 kg / ~ 7 W / 230 V / ■ ■ LED / ☆ T-1 / 7 1/2 C 8 .U.
- 150-742 / ~ 30 x 38 cm / ~ 0.8 kg / ~ 3 W / 36 V / ■ ■ LED / ☆ T-1 / 6.5 1/2 C 20 .U.
- 150-145 / ~ 43 x 55 cm / ~ 1.5 kg / ~ 7 W / 230 V / ■ ■ LED / ☆ T-1 / 7 1/2 C 8 .U.
- 150-745 / ~ 43 x 55 cm / ~ 1.5 kg / ~ 3 W / 36 V / ■ ■ LED / ☆ T-1 / 6.5 1/2 C 20 .U.
- 150-050 / ~ 73 x 95 cm / ~ 3 kg / ~ 14 W / 230 V / ■ ■ LED / ☆ T-1 / 7 1/2 C 8 .U.
- 150-550 / ~ 73 x 95 cm / ~ 3 kg / ~ 6 W / 36 V / ■ ■ LED / ☆ T-1 / 6.5 1/2 C 20 .U.
- 150-143 / ~ 30 x 38 cm / ~ 0.8 kg / ~ 7 W / 230 V / ■ LED / ☆ T-1 / 7 1/2 C 8 .U.
- 150-743 / ~ 30 x 38 cm / ~ 0.8 kg / ~ 3 W / 36 V / ■ LED / ☆ T-1 / 6.5 1/2 C 20 .U.
- 150-146 / ~ 43 x 55 cm / ~ 1.5 kg / ~ 7 W / 230 V / ■ LED / ☆ T-1 / 7 1/2 C 8 .U.
- 150-746 / ~ 43 x 55 cm / ~ 1.5 kg / ~ 3 W / 36 V / ■ LED / ☆ T-1 / 6.5 1/2 C 20 .U.
- 150-051 / ~ 73 x 95 cm / ~ 3 kg / ~ 14 W / 230 V / ■ LED / ☆ T-1 / 7 1/2 C 8 .U.
- 150-551 / ~ 73 x 95 cm / ~ 3 kg / ~ 6 W / 36 V / ■ LED / ☆ T-1 / 6.5 1/2 C 20 .U.
- 150-144 / ~ 30 x 38 cm / ~ 0.8 kg / ~ 7 W / 230 V / ■ ■ LED / ☆ T-1 / 7 1/2 C 8 .U.
- 150-744 / ~ 30 x 38 cm / ~ 0.8 kg / ~ 3 W / 36 V / ■ ■ LED / ☆ T-1 / 6.5 1/2 C 20 .U.
- 150-147 / ~ 43 x 55 cm / ~ 1.5 kg / ~ 7 W / 230 V / ■ ■ LED / ☆ T-1 / 7 1/2 C 8 .U.
- 150-747 / ~ 43 x 55 cm / ~ 1.5 kg / ~ 3 W / 36 V / ■ ■ LED / ☆ T-1 / 6.5 1/2 C 20 .U.
- 150-052 / ~ 73 x 95 cm / ~ 3 kg / ~ 14 W / 230 V / ■ ■ LED / ☆ T-1 / 7 1/2 C 8 .U.
- 150-552 / ~ 73 x 95 cm / ~ 3 kg / ~ 6 W / 36 V / ■ ■ LED / ☆ T-1 / 6.5 1/2 C 20 .U.

LIGHT MOTIFS





Organic 2D



Christmas











② Organic Surprise





② Organic Surprise





150-047 / ~ 97 x 86 cm / ~ 5 kg / ~ 14 W / 230 V /   LED / ☆ T-1 /  

150-547 / ~ 97 x 86 cm / ~ 5 kg / ~ 6 W / 36 V /   LED / ☆ T-1 /  

150-048 / ~ 97 x 86 cm / ~ 5 kg / ~ 14 W / 230 V /   LED / ☆ T-1 /  

150-548 / ~ 97 x 86 cm / ~ 5 kg / ~ 6 W / 36 V /   LED / ☆ T-1 /  

150-049 / ~ 97 x 86 cm / ~ 5 kg / ~ 14 W / 230 V /   LED / ☆ T-1 /  

150-549 / ~ 97 x 86 cm / ~ 5 kg / ~ 6 W / 36 V /   LED / ☆ T-1 /  

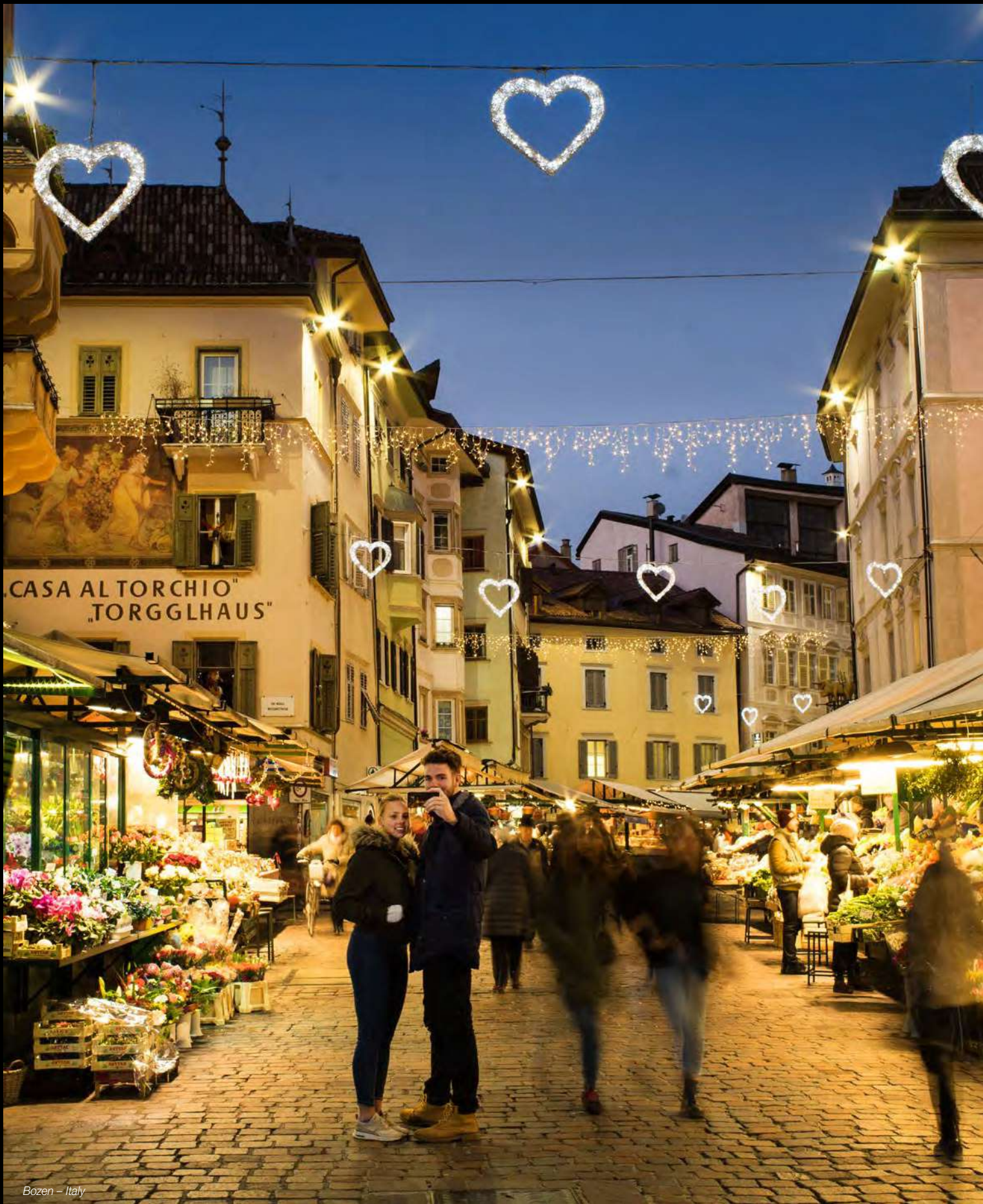

Bozen - Italy



Antwerpen – Belgium



Emsgalerie Rheine – Germany



Cape Town – South Africa



Budapest – Hungary

LIGHT MOTIFS

Organic 3D

Balls without light



	10 cm / 0,09 kg	12 cm / 0,12 kg	17 cm / 0,2 kg	22 cm / 0,4 kg	40 cm / 1,2 kg	60 cm / 3,8 kg	80 cm / 6,4 kg	108 cm / 6,4 kg
■	938-024	938-025	931-364	931-369	931-374	931-383	931-393	931-919
■	938-791	939-004	938-726	938-739	938-752	938-765	938-778	931-920
■	939-002	939-454	938-737	938-750	938-763	938-776	938-789	931-921
■	931-863	931-864	931-362	931-367	931-372	931-379	931-389	931-922
■	938-792	939-445	938-727	938-740	938-753	938-766	938-779	931-923
■	938-793	939-448	938-728	938-741	938-754	938-767	938-780	931-924
■	938-036	938-037	931-361	931-366	931-371	931-377	931-387	931-397
■	938-800	939-452	938-735	938-748	938-761	938-774	938-787	931-925
■	939-001	939-453	938-736	938-749	938-762	938-775	938-788	931-926
■	938-794	939-447	938-729	938-742	938-755	938-768	938-781	931-927
■	938-790	939-003	938-725	938-738	938-751	938-764	938-777	931-928
■	938-797	939-446	938-732	938-745	938-758	938-771	938-784	931-929
■	938-798	939-450	938-733	938-746	938-759	938-772	938-785	941-402
■	938-799	939-451	938-734	938-747	938-760	938-773	938-786	931-930
■	938-796	939-449	938-731	938-723	938-757	938-721	938-783	931-931
■	938-795	939-005	938-730	938-743	938-756	938-769	938-782	941-397
■	931-881	931-866	931-363	931-368	931-373	931-381	931-391	931-401

☆ 3D / 1 part 6

☆ 3D / 2 parts 1



Blue



Dark Blue



Pastel Blue



Green



Pine Green



Grass Green



Red



Pastel Yellow



Orange



Copper Brown



Brown



Black Brown



Grey



Pastel Pink



Violet



Brilliant Gold



White



Sint-Truiden – Belgium

	17 cm / 0,8 kg		22 cm / 0,9 kg		40 cm / 1,8 kg	
	230 V / 7 W	36 V / 3 W	230 V / 7 W	36 V / 3 W	230 V / 7 W	36 V / 3 W
LED	150-053	150-553	150-070	150-570	150-087	150-587
LED	150-054	150-554	150-071	150-571	150-088	150-588
LED	150-055	150-555	150-072	150-572	150-089	150-589
LED	150-056	150-556	150-073	150-573	150-090	150-590
LED	150-057	150-557	150-074	150-574	150-091	150-591
LED	150-058	150-558	150-075	150-575	150-092	150-592
LED	150-059	150-559	150-076	150-576	150-093	150-593
LED	150-060	150-560	150-077	150-577	150-094	150-594
LED	150-061	150-561	150-078	150-578	150-095	150-595
LED	150-062	150-562	150-079	150-579	150-096	150-596
LED	150-063	150-563	150-080	150-580	150-097	150-597
LED	150-064	150-564	150-081	150-581	150-098	150-598
LED	150-065	150-565	150-082	150-582	150-099	150-599
LED	150-066	150-566	150-083	150-583	150-100	150-600
LED	150-067	150-567	150-084	150-584	150-101	150-601
LED	150-068	150-568	150-085	150-585	150-102	150-602
LED	150-069	150-569	150-086	150-586	150-103	150-603
	★ 3D / 1 part 6				★ 3D / 2 parts 1	
	3.5°C	3.25°C	3.5°C	3.25°C	3.5°C	3.25°C
	4.U	10.U	4.U	10.U	4.U	10.U



Toronto – Canada

LIGHT MOTIFS

Organic 3D Balls

	60 cm / 4,3 kg		80 cm / 8,0 kg		108 cm / 15 kg	
	230 V / 10,5 W	36 V / 4,5 W	230 V / 10,5 W	36 V / 6 W	230 V / 21 W	36 V / 14 W
 LED	150-104	150-604	150-121	150-621	150-182	150-782
 LED	150-105	150-605	150-122	150-622	150-183	150-783
 LED	150-106	150-606	150-123	150-623	150-184	150-784
 LED	150-107	150-607	150-124	150-624	150-185	150-785
 LED	150-108	150-608	150-125	150-625	150-186	150-786
 LED	150-109	150-609	150-126	150-626	150-187	150-787
 LED	150-110	150-610	150-127	150-627	150-188	150-788
 LED	150-111	150-611	150-128	150-628	150-189	150-789
 LED	150-112	150-612	150-129	150-629	150-190	150-790
 LED	150-113	150-613	150-130	150-630	150-191	150-791
 LED	150-114	150-614	150-131	150-631	150-192	150-792
 LED	150-115	150-615	150-132	150-632	150-193	150-793
 LED	150-116	150-616	150-133	150-633	150-194	150-794
 LED	150-117	150-617	150-134	150-634	150-195	150-795
 LED	150-118	150-618	150-135	150-635	150-196	150-796
 LED	150-119	150-619	150-136	150-636	150-197	150-797
 LED	150-120	150-620	150-137	150-637	150-198	150-798

☆ 30 / 2 parts  1

5 1/2 C-
20.5 U.

5 1/2 C-
31.5 U.

8.3 1/2 C-
30.5 U.

6.66 1/2 C-
41.5 U.

15 1/2 C-
60.5 U.

15 1/2 C-
91.5 U.

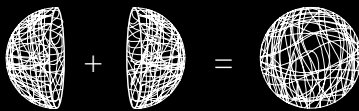

2 parts



Uppsala – Sweden



Stuttgart – Germany

LIGHT MOTIFS

Organic 3D Animated

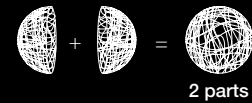

excl. Controller **96**

	17 cm / 0,8 kg	22 cm / 0,9 kg	40 cm / 1,8 kg	60 cm / 4,3 kg	80 cm / 8,0 kg					
	-	36 V / 8 W	-	36 V / 8 W	-	36 V / 16 W	-	36 V / 24 W		
	-	150-805	-	150-806	-	150-807	-	150-808	-	150-809
	☆ 3D / 1 part		☆ 3D / 2 parts							
	8.5		8.5		8.5		17		25.5	
	15		15		15		30		45	

DualColour excl. Controller **107**

	17 cm / 0,8 kg	22 cm / 0,9 kg	40 cm / 1,8 kg	60 cm / 4,3 kg	80 cm / 8,0 kg					
	-	36 V / 3 W	-	36 V / 3 W	-	36 V / 4.5 W	-	36 V / 6 W		
	-	150-705	-	150-706	-	150-707	-	150-708	-	150-709
	☆ 3D / 1 part		☆ 3D / 2 parts							
	3.25		3.25		3.25		5		6.75	
	10		10		10		30		40	

i-Balls excl. Controller **113**

	17 cm / 0,4 kg	22 cm / 0,5 kg	40 cm / 1,4 kg	60 cm / 3,9 kg	80 cm / 6,4 kg					
	-	36 V / 3 W	-	36 V / 3 W	-	36 V / 5 W	-	36 V / 10 W	-	36 V / 15 W
	-	150-775	-	150-776	-	150-777	-	150-778	-	150-779
	incl. 1 x 011-144		incl. 1 x 011-144		incl. 2 x 011-144		incl. 4 x 011-144		incl. 6 x 011-144	
	☆ 3D / 1 part		☆ 3D / 2 parts							

RGB excl. Controller **111**

	17 cm / 0,8 kg	22 cm / 0,9 kg	40 cm / 1,8 kg	60 cm / 4,3 kg	80 cm / 8,0 kg					
	-	36 V / 2 W	-	36 V / 2 W	-	36 V / 4 W	-	36 V / 6 W		
	-	150-800	-	150-801	-	150-802	-	150-803	-	150-804
	☆ 3D / 1 part		☆ 3D / 2 parts							
	4		4		4		8		12	
	16.8		16.8		16.8		33.6		50.4	



Frankfurt – Germany

LIGHT MOTIFS

Organic 3D Pole















① Organic Star Pole



② Organic Bell Pole



③ Organic Tree Pole

-
- ① Organic Star Pole 150-138 / ~ 63 x 71 x 20 cm / ~ 2.8 kg / ~ 7 W / 230 V /  LED /  P-2, 60 cm /  QuickFix™
- 150-139 / ~ 105 x 105 x 36 cm / ~ 5.4 kg / ~ 14 W / 230 V /  LED /  P-2, 80 cm /  QuickFix™
- ② Organic Bell Pole 150-140 / ~ 94 x 140 x 28 cm / ~ 7 kg / ~ 10.5 W / 230 V /  LED /  P-2, 120 cm /  QuickFix™
- ③ Organic Tree Pole 150-141 / ~ 87x 120 x 38 cm / ~ 7.6 kg / ~ 14 W / 230 V /  LED /  P-2, 100 cm /  QuickFix™



Hückelhoven – Germany

LIGHT MOTIFS

Edison



① Edison XL Decro Lite

① Edison XL Decro Lite 029-155 / ~28 x 50 x 28 cm / ~1.1 kg / 36 V / ~ 3.8 W / LED / ☆ T-1 / 3D 1 5 45 U

LIGHT MOTIFS

Edison



① Edison XL



② Edison L





-
- ① Edison XL 029-214 / ~28 x 50 x 28 cm / ~ 1.3 kg / 36 V / ~ 3.5 W /  / ☆ T-1 /     45    
- ② Edison L 029-215 / ~15 x 25 x 15 cm / ~ 0.4 kg / 36 V / ~ 2.1 W /  / ☆ T-1 /     25    

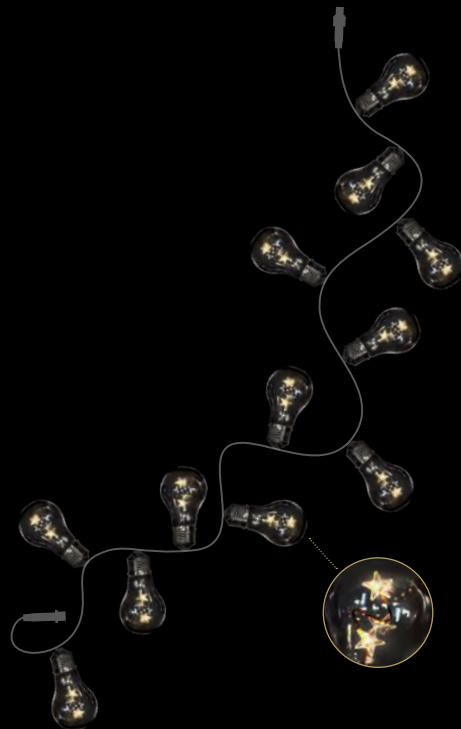







③ Edison XL RGB DMX



④ Edison String Lite

③ Edison XL RGB DMX 029-156 / ~28 x 50 x 28 cm / ~1.5 kg / 36 V / ~ 10.8 W /  / ☆ T-1 /   excl. Controller 

④ Edison String Lite 029-157 / ~4 m / ~ 0.3 kg / 12 bulbs / 36 V / ~ 0.3 W /  /      

LIGHT MOTIFS

Fading Series 36V INDOOR USE ONLY



① Star Fading

② Flake Fading

① Star Fading 029-158 / ~ Ø 50 cm / ~ 1.7 kg / 36 V / ~ 3.6 W / LED / ☆ T-1 / 3D  4  15 .U. 

② Flake Fading 029-160 / ~ Ø 50 cm / ~ 1.9 kg / 36 V / ~ 3.6 W / LED / ☆ T-1 / 3D  4  30 .U. 

LIGHT MOTIFS

Deco Series 36V INDOOR USE ONLY

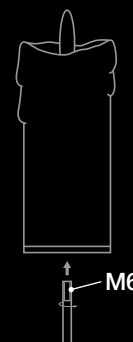

Outdoor

abraxus
by MK Illumination

① Frozen Flake

② Frozen Pentor

③ Deco Candle

① Frozen Flake	029-164 / ~ Ø 45 cm / ~ 0.9 kg / 36 V / ~ 3.6 W / LED / ☆ T-1 /  4  15  
	029-165 / ~ Ø 70 cm / ~ 1 kg / 36 V / ~ 3.6 W / LED / ☆ T-1 /  4  25  
② Frozen Pentor	029-166 / ~ Ø 35 cm / ~ 0.8 kg / 36 V / ~ 3.6 W / LED / ☆ T-1 /  4  15  
③ Deco Candle	029-163 / ~ 9 x 24 cm / ~ 0.5 kg / 36 V / ~ 2 W / LED /  3  10  



LIGHT MOTIFS

Kronux Stars







































2200K



① Sidus



② Sidus Six

- ① Sidus 008-000 / ~ Ø 112 cm / ~ 3.9 kg / ~ 16 W / LED / ☆ T-2 / ☆+f 008-200 /            
- 008-001 / ~ Ø 164 cm / ~ 4.9 kg / ~ 16 W / LED / ☆ T-2 / ☆+f 008-200 /        
- ② Sidus Six 008-010 / ~ Ø 112 cm / ~ 3.8 kg / ~ 19 W / LED / ☆ T-2 / ☆+f 008-200 /        
- 008-003 / ~ Ø 164 cm / ~ 5.8 kg / ~ 19 W / LED / ☆ T-2 / ☆+f 008-200 /        









incl. CC 500 mA Driver



① Sirius



② Nexus

- ① Sirius 008-011 / ~ Ø 112 cm / ~ 3,5 kg / ~ 32 W / LED / ☆ T-2 / ☆+⌂ 008-200 /  1   5
- 008-004 / ~ Ø 164 cm / ~ 5,5 kg / ~ 32 W / LED / ☆ T-2 / ☆+⌂ 008-200 /  1   5
- ④ Nexus 008-007 / ~125 x 200 cm / ~ 4,5 kg / ~ 24 W / LED / ⌂☆ P-2, 28,5 cm /  1   5
- incl. Mounting System & Driver

incl. CC 500 mA Driver

LIGHT MOTIFS

Kronux Stars



2200K

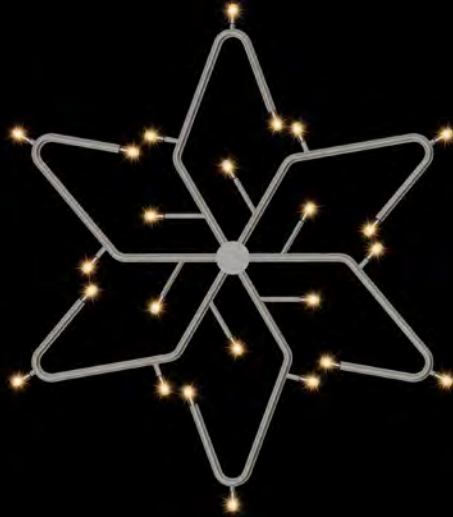

③ Stark



④ Branch

③ Stark 008-013 / ~ Ø 112 cm / ~ 4 kg / ~ 38 W / / ☆ T-2 / ☆+⌂ 008-200 /

④ Branch 008-014 / ~ 80 x 150 cm / ~ 3.9 kg / ~ 22 W / / ☆ P-2, 100 cm /

incl. CC 500 mA Driver



London – UK

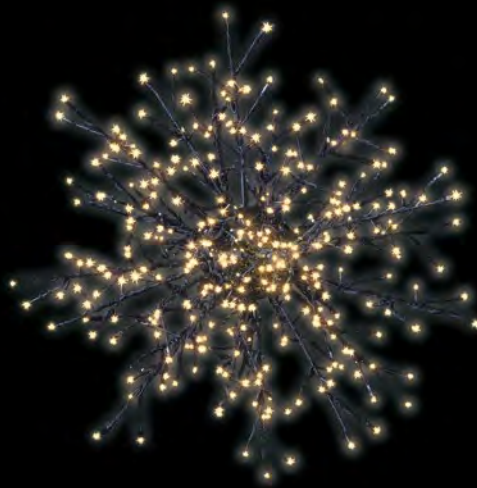

① Antares 3D

① Antares 3D

160-513 / Ø 53 cm / ~ 2 kg / 36 V / ~ 10 W / LED /  /  T-1 /  /  /  /  /  / 
160-517 / Ø 85 cm / ~ 5 kg / 36 V / ~ 15 W / LED /  /  T-1 /  /  /  /  /  / 
160-514 / Ø 53 cm / ~ 2 kg / 36 V / ~ 10 W / LED /  /  T-1 /  /  /  /  /  / 
160-518 / Ø 85 cm / ~ 5 kg / 36 V / ~ 15 W / LED /  /  T-1 /  /  /  /  /  / 
160-515 / Ø 53 cm / ~ 2 kg / 36 V / ~ 10 W / LED /  /  T-1 /  /  /  /  /  / 
160-519 / Ø 85 cm / ~ 5 kg / 36 V / ~ 15 W / LED /  /  T-1 /  /  /  /  /  / 
160-516 / Ø 53 cm / ~ 2 kg / 36 V / ~ 10 W / LED /  /  T-1 /  /  /  /  /  / 
160-520 / Ø 85 cm / ~ 5 kg / 36 V / ~ 15 W / LED /  /  T-1 /  /  /  /  /  / 

LIGHT MOTIFS

Abraxus

Ball & Star

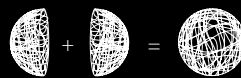

2 parts

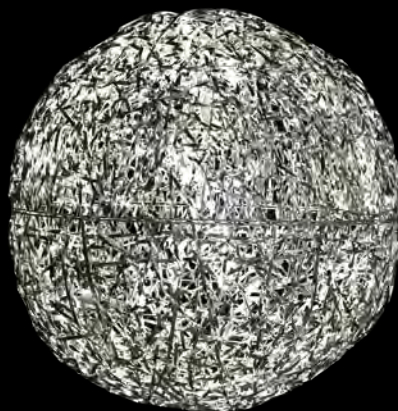



② Orbitals 3D



② Orbitals 3D

160-525 / Ø 10 cm / ~ 0.5 kg / ■ / ☆ T-1 3D /  1

035-242 / Ø 20 cm / ~ 1 kg / ■ / ☆ T-1 3D /  1

035-243 / Ø 30 cm / ~ 2 kg / ■ / ☆ T-1 3D /  1



035-244 / Ø 40 cm / ~ 2.5 kg / ■ / ☆ T-1 3D /  1

035-245 / Ø 60 cm / ~ 4 kg / ■ / ☆ T-1 3D /  1

035-246 / Ø 80 cm / ~ 5.5 kg / ■ / ☆ T-1 3D /  1

160-521 / Ø 20 cm / ~ 1 kg / 36 V / ~ 1.5 W /  / ☆ T-1 3D /  1 2 V-C 5 .U.  100

160-526 / Ø 30 cm / ~ 2 kg / 36 V / ~ 1.5 W /  / ☆ T-1 3D /  1 2 V-C 5 .U.  100

160-522 / Ø 40 cm / ~ 2.5 kg / 36 V / ~ 2.2 W /  / ☆ T-1 3D /  1 3 V-C 10 .U.  100

160-523 / Ø 60 cm / ~ 4 kg / 36 V / ~ 2.9 W /  / ☆ T-1 3D /  1 4 V-C 10 .U.  100

160-524 / Ø 80 cm / ~ 5.5 kg / 36 V / ~ 4.3 W /  / ☆ T-1 3D /  1 6 V-C 15 .U.  100

LIGHT MOTIFS

Strip Series 3D

QuickFix™ Collection

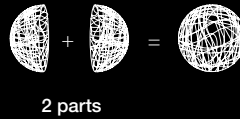





































① Strip Star



② Strip Heart



③ Strip Tree

- ① Strip Star
- 160-001 / ~ 95 x 91 x 20 cm / ~ 6 kg / ~ 115 W / LED / ☆ T-2 / ☆+⌂ 941-033  1  53  40  50  U  E27
- 160-002 / ~ 95 x 91 x 20 cm / ~ 6 kg / ~ 115 W / LED / ☆ T-2 / ☆+⌂ 941-033  1  53  40  50  U  E27
- ② Strip Heart
- 160-003 / ~ 100 x 90 x 20 cm / ~ 7 kg / ~ 106 W / LED / ☆ T-2 / ☆+⌂ 941-033  1  49  40  46  U  E27
- 160-004 / ~ 100 x 90 x 20 cm / ~ 7 kg / ~ 106 W / LED / ☆ T-2 / ☆+⌂ 941-033  1  49  40  46  U  E27
- ③ Strip Tree
- 160-005 / ~ 100 x 82 x 20 cm / ~ 5 kg / ~ 87 W / LED / ☆ T-2 / ☆+⌂ 941-033  1  40  40  40  U  E27
- 160-006 / ~ 100 x 82 x 20 cm / ~ 5 kg / ~ 87 W / LED / ☆ T-2 / ☆+⌂ 941-033  1  40  40  40  U  E27

LIGHT MOTIFS

Silent Night

QuickFix™ Collection



① Stella



② Virgo Star



③ Libra Star

① Stella

160-013 / ~ 82 x 82 cm / ~ 1.8 kg / ~ 25 W / LED / ☆ T-2 / ☆+ 941-017 / 1 12.5' C 12 U. 1000 1000

160-014 / ~ 109 x 109 cm / ~ 2.2 kg / ~ 28 W / LED / ☆ T-2 / ☆+ 941-033 / 1 14' C 15 U. 1000 1000

② Virgo Star

160-015 / ~ 99 x 99 cm / ~ 3.6 kg / ~ 46 W / LED / ☆ T-2 / ☆+ 941-033 / 1 23' C 25 U. 1000 1000

③ Libra Star

160-016 / ~ 85 x 85 cm / ~ 1.8 kg / ~ 25 W / LED / ☆ T-2 / ☆+ 941-017 / 1 12.5' C 17.5 U. 1000 1000

160-017 / ~ 115 x 115 cm / ~ 2.8 kg / ~ 35 W / LED / ☆ T-2 / ☆+ 941-033 / 1 18' C 25 U. 1000 1000



München – Germany

LIGHT MOTIFS

Stars

QuickFix™ Collection

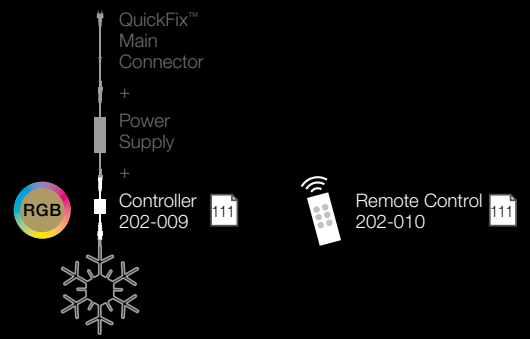

NEW



① Reva

RGB

NEW



② Star Crystal

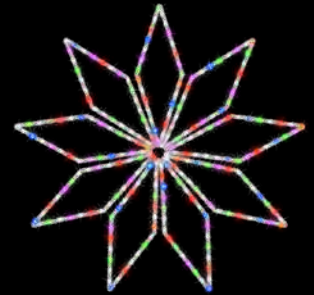

① Reva

160-066 / ~ 59 x 69 cm / ~ 2 kg / ~ 7 W / LED / ☆ T-1 / ☆+⌂ 941-017        

160-070 / ~ 59 x 69 cm / ~ 2 kg / ~ 7 W / LED / ☆ T-1 / ☆+⌂ 941-017        

② Star Crystal

160-067 / ~ 88 x 87 cm / ~ 3 kg / ~ 11 W / LED / ☆ T-1 / ☆+⌂ 941-017        

160-074 / ~ 88 x 87 cm / ~ 3 kg / ~ 11 W / LED / ☆ T-1 / ☆+⌂ 941-017        

160-076 / ~ 88 x 87 cm / ~ 3 kg / 36 V / ~ 10 W / LED / ☆ T-1 / ☆+⌂ 941-017        

NEW



① Pentor



② Comet

① Pentor

- 160-065 / ~ 30 x 30 cm / ~ 0.4 kg / ~ 2.5 W / LED / ☆ T-1 / ☆+Γ 941-061 / **1.5' C** **3 .U.**
- 160-062 / ~ 30 x 30 cm / ~ 0.4 kg / ~ 2.5 W / LED / ☆ T-1 / ☆+Γ 941-061 / **1.5' C** **3 .U.**
- 160-018 / ~ 45 x 45 cm / ~ 0.7 kg / ~ 3 W / LED / ☆ T-1 / ☆+Γ 941-061 / **2' C** **3 .U.**
- 160-019 / ~ 45 x 45 cm / ~ 0.7 kg / ~ 3 W / LED / ☆ T-1 / ☆+Γ 941-061 / **2' C** **3 .U.**
- 160-020 / ~ 70 x 70 cm / ~ 1.8 kg / ~ 13 W / LED / ☆ T-2 / ☆+Γ 941-017 / **9' C** **11 .U.**
- 160-063 / ~ 70 x 70 cm / ~ 1.8 kg / ~ 13 W / LED / ☆ T-2 / ☆+Γ 941-017 / **9' C** **11 .U.**
- 160-021 / ~ 95 x 95 cm / ~ 2.5 kg / ~ 16 W / LED / ☆ T-2 / ☆+Γ 941-033 / **12.5' C** **15.5 .U.**
- 160-064 / ~ 95 x 95 cm / ~ 2.5 kg / ~ 16 W / LED / ☆ T-2 / ☆+Γ 941-033 / **12.5' C** **15.5 .U.**

② Comet

- 160-022 / ~ 135 x 70 cm / ~ 3.5 kg / ~ 23 W / LED / ☆ T-2 / **18' C** **22 .U.**

LIGHT MOTIFS

Stars

QuickFix™ Collection

















③ Wega



④ Wega Oval



⑤ Orion

- ③ Wega 160-023 / ~ 85 x 85 cm / ~ 2.5 kg / ~ 19 W / LED / ☆ T-2 / ☆+⌈ 941-017 /  12.5°C 15.5.U.  
- 160-024 / ~ 120 x 120 cm / ~ 3.6 kg / ~ 25 W / LED / ☆ T-2 / ☆+⌈ 941-033 /  19°C 23.5.U.  
- ④ Wega Oval 160-025 / ~ 65 x 85 cm / ~ 2.3 kg / ~ 16 W / LED / ☆ T-2 / ☆+⌈ 941-017 /  11°C 14.U.  
- ⑤ Orion 160-026 / ~ 95 x 95 cm / ~ 3.5 kg / ~ 21 W / LED / ☆ T-2 / ☆+⌈ 941-033 /  14°C 18.U.  
- 160-027 / ~ 125 x 125 cm / ~ 4 kg / ~ 30 W / LED / ☆ T-2 / ☆+⌈ 941-033 /  19°C 23.5.U.  

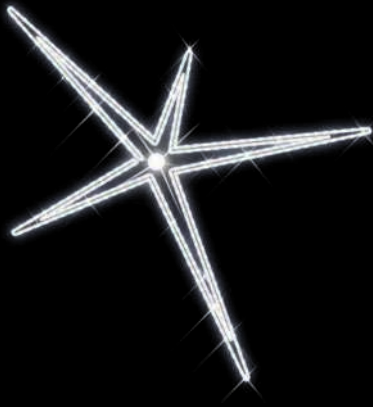
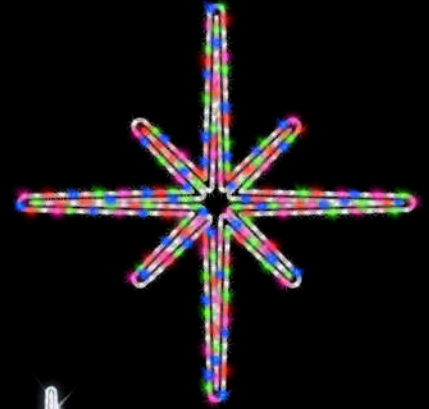
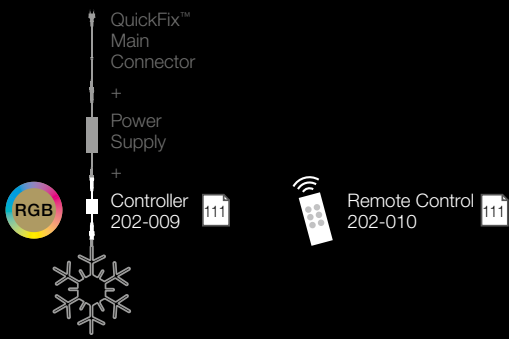

① Astero 3
230 V AC only

② Astero Star

- ① Astero 3 160-028 / ~128 x 128 cm / ~ 4 kg / ~ 23 W / LED / x1 / ☆ T-3 / ☆+Γ 941-033 / 18 V-C 22 U
- ② Astero Star 160-029 / ~105 x 105 cm / ~ 2.5 kg / ~ 27.5 W / LED / ☆ T-2 / ☆+Γ 941-033 / 18 V-C 22 U
 160-077 / ~105 x 105 cm / ~ 2.5 kg / 36 V / ~ 15 W / LED / ☆ T-2 / ☆+Γ 941-033 / 18 V-C 22 U
 160-030 / ~145 x 145 cm / ~ 4.5 kg / ~ 34.5 W / LED / ☆ T-2 / ☆+Γ 941-033 / 26 V-C 32 U

LIGHT MOTIFS

Astero

QuickFix™ Collection



③ Astero 1
230 V AC only



④ Astero 1

③ Astero 1 160-031 / ~ 63 x 63 cm / ~ 1 kg / ~ 8 W / LED / x1 / ☆ T-2 / ☆+ 941-061 / 6 °C 8 U.

④ Astero 1 160-032 / ~ 63 x 63 cm / ~ 1 kg / ~ 4.5 W / LED / ☆ T-1 / ☆+ 941-061 / 3.5 °C 4.5 U.

160-033 / ~ 63 x 63 cm / ~ 1 kg / ~ 4.5 W / LED / ☆ T-1 / ☆+ 941-061 / 3.5 °C 4.5 U.



① Classic Flake



② Snow Flake

- ① Classic Flake
- 160-034 / ~ 55 x 55 cm / ~ 1.2 kg / ~ 6 W / LED / ☆ T-1 / ☆+Γ 941-061 /
 - 160-035 / ~ 55 x 55 cm / ~ 1.2 kg / ~ 6 W / LED / ☆ T-1 / ☆+Γ 941-061 /
 - 160-036 / ~ 85 x 85 cm / ~ 2.5 kg / ~ 21 W / LED / ☆ T-2 / ☆+Γ 941-017 /
 - 160-037 / ~ 105 x 105 cm / ~ 3 kg / ~ 27 W / LED / ☆ T-2 / ☆+Γ 941-033 /
- ② Snow Flake
- 160-038 / ~ 55 x 55 cm / ~ 1.2 kg / ~ 6 W / LED / ☆ T-1 / ☆+Γ 941-061 /
 - 160-039 / ~ 55 x 55 cm / ~ 1.2 kg / ~ 6 W / LED / ☆ T-1 / ☆+Γ 941-061 /
 - 160-040 / ~ 85 x 85 cm / ~ 2.5 kg / ~ 19 W / LED / ☆ T-2 / ☆+Γ 941-017 /
 - 160-041 / ~ 105 x 105 cm / ~ 3 kg / ~ 27 W / LED / ☆ T-2 / ☆+Γ 941-033 /

LIGHT MOTIFS

Flakes

QuickFix™ Collection

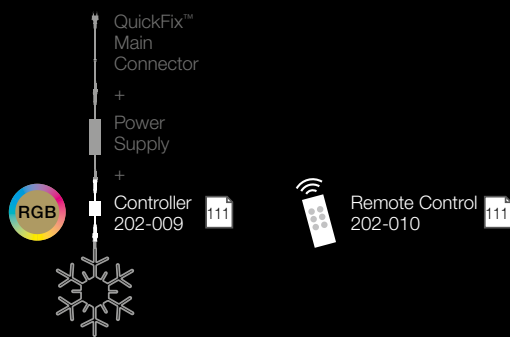

NEW



NEW

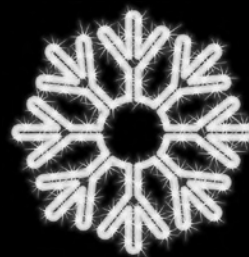

③ Polaris

④ Flake Olivia

⑤ Ice

③ Polaris

- 160-042 / ~ 40 x 50 cm / ~ 0,65 kg / ~ 3 W / LED / ☆ T-1 / ☆+f 941-061 /
- 160-043 / ~ 40 x 50 cm / ~ 0,65 kg / ~ 3 W / LED / ☆ T-1 / ☆+f 941-061 /
- 160-078 / ~ 40 x 50 cm / ~ 0,65 kg / 36 V / ~ 5 W / LED / ☆ T-2 / ☆+f 941-061 /
- 160-044 / ~ 70 x 95 cm / ~ 1,5 kg / ~ 13 W / LED / ☆ T-2 / ☆+f 941-033 /
- 160-045 / ~ 70 x 95 cm / ~ 1,5 kg / ~ 13 W / LED / ☆ T-2 / ☆+f 941-033 /

④ Flake Olivia

- 160-046 / ~ 63 x 63 cm / ~ 3 kg / ~ 16 W / LED / ☆ T-2 / ☆+f 941-017 /
- 160-079 / ~ 63 x 63 cm / ~ 3 kg / 36 V / ~ 12 W / LED / ☆ T-2 / ☆+f 941-017 /

⑤ Ice

- 160-047 / ~ 40 x 40 cm / ~ 1 kg / ~ 6 W / LED / ☆ T-1 / ☆+f 941-061 /
- 160-048 / ~ 40 x 40 cm / ~ 1 kg / ~ 6 W / LED / ☆ T-1 / ☆+f 941-061 /

LIGHT MOTIFS

Flakes

QuickFix™ Collection





















① Snow Crystal



② Norway Flake



③ Baltic Crystal

① Snow Crystal	160-049 / ~ 131 x 131 cm / ~ 6 kg / ~ 49 W /  / ☆ T-2 / ☆+  941-033 /   34.5°C  44 U  E5
② Norway Flake	160-050 / ~ 80 x 80 cm / ~ 2.7 kg / ~ 21.5 W /  / ☆ T-2 / ☆+  941-017 /   14°C  18 U  E5
③ Baltic Crystal	160-051 / ~ 100 x 100 cm / ~ 4 kg / ~ 32 W /  / ☆ T-2 / ☆+  941-033 /   21°C  27 U  E5

LIGHT MOTIFS

Traditional QuickFix™ Collection









④ Traditional Pentor



⑤ Traditional Wega



⑥ Traditional Star

- ④ Traditional Pentor 160-052 / ~ 125 x 125 cm / ~ 7 kg / ~ 30 W / LED / ☆ T-2 / ☆+⌂ 941-033 /  15 'C- 23 .U. 
- ⑤ Traditional Wega 160-053 / ~ 125 x 125 cm / ~ 8 kg / ~ 35 W / LED / ☆ T-2 / ☆+⌂ 941-033 /  18 'C- 34 .U. 
- ⑥ Traditional Star 160-054 / ~ 120 x 120 cm / ~ 7 kg / ~ 30 W / LED / ☆ T-2 / ☆+⌂ 941-033 /  15 'C- 23 .U. 

Foldables 3D

QuickFix™ Collection

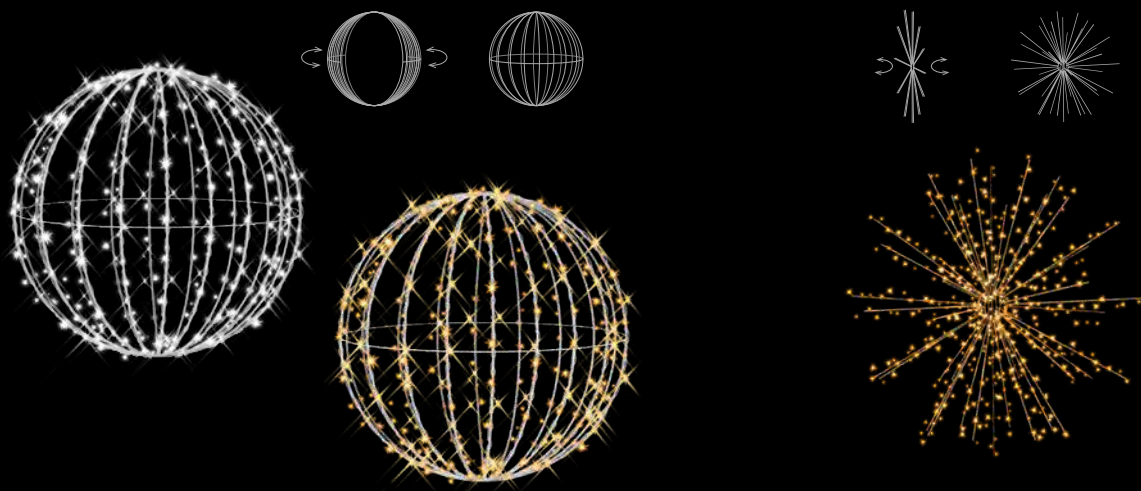

① Foldable Meridian 3D
Power Supply on page 107

② Foldable Snowball 3D
Power Supply on page 107

① Foldable Meridian 3D	160-501 / Ø 50 cm / ~ 3.2 kg / 36 V / ~ 9 W / LED / ☆ T-1 3D / / 11 V-C / 30 U /
	160-502 / Ø 80 cm / ~ 7 kg / 36 V / ~ 20 W / LED / ☆ T-1 3D / / 27.5 V-C / 70 U /
	160-503 / Ø 110 cm / ~ 12 kg / 36 V / ~ 35 W / LED / ☆ T-1 3D / / 44 V-C / 120 U /
	160-504 / Ø 50 cm / ~ 3.2 kg / 36 V / ~ 9 W / LED / ☆ T-1 3D / / 11 V-C / 30 U /
	160-505 / Ø 80 cm / ~ 7 kg / 36 V / ~ 20 W / LED / ☆ T-1 3D / / 27.5 V-C / 70 U /
	160-506 / Ø 110 cm / ~ 12 kg / 36 V / ~ 35 W / LED / ☆ T-1 3D / / 44 V-C / 120 U /
② Foldable Snowball 3D	160-507 / Ø 60 cm / ~ 3.5 kg / 36 V / ~ 14.5 W / LED / ☆ T-1 3D / / 30 V-C / 82 U /
	160-508 / Ø 80 cm / ~ 4.8 kg / 36 V / ~ 20.5 W / LED / ☆ T-1 3D / / 37 V-C / 100 U /
	160-509 / Ø 120 cm / ~ 6.5 kg / 36 V / ~ 31 W / LED / ☆ T-1 3D / / 65 V-C / 182 U /
	160-510 / Ø 60 cm / ~ 3.5 kg / 36 V / ~ 14.5 W / LED / ☆ T-1 3D / / 30 V-C / 82 U /
	160-511 / Ø 80 cm / ~ 4.8 kg / 36 V / ~ 20.5 W / LED / ☆ T-1 3D / / 37 V-C / 100 U /
	160-512 / Ø 120 cm / ~ 6.5 kg / 36 V / ~ 31 W / LED / ☆ T-1 3D / / 65 V-C / 182 U /

LIGHT MOTIFS

Balls

QuickFix™ Collection

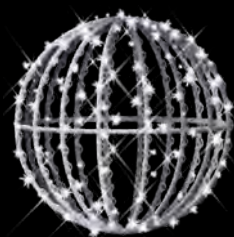

③ Meridian 3D



④ Snowball 3D



⑤ Skyball 3D

③ Meridian 3D	160-055 / Ø 40 cm / ~ 3 kg / ~ 15 W / / ☆ T-1 / ☆+f 941-061 /
	160-056 / Ø 40 cm / ~ 3 kg / ~ 15 W / / ☆ T-1 / ☆+f 941-061 /
④ Snowball 3D	160-057 / Ø 40 cm / ~ 2 kg / ~ 20 W / / ☆ T-1 / ☆+f 941-061 /
	160-058 / Ø 40 cm / ~ 2 kg / ~ 20 W / / ☆ T-1 / ☆+f 941-061 /
⑤ Skyball 3D	160-059 / Ø 40 cm / ~ 3.5 kg / ~ 9 W / / ☆ T-1 / ☆+f 941-061 /
	160-060 / Ø 40 cm / ~ 3.5 kg / ~ 9 W / / ☆ T-1 / ☆+f 941-061 /



Hückelhoven - Germany



Abensberg – Germany





Hückelhoven – Germany



Innsbruck – Austria

LIGHT MOTIFS

Anwendungen

- 1 direkt mit einem QuickFix™ Verbinder ausgestattet
- 2 koppelbar mit den QuickFix™ Produkten
- 3 QuickFix™ Outdoor+ direkt koppelbar mit QuickFix™-Indoor Produkten (mit Adapter 015-076)
- 4 perfekt abgestimmt auf die Collections Designs und Gruppen
- 5 teilweise auch für Mastmontage mit Rahmen geeignet
- 6 beschichtete Konstruktion
- 7 optionales Zubehör für die Mastmontage
- 8 optionales Zubehör erforderlich:
 -  Netzstecker + AC/DC 129
 -  Netzstecker + Power Supply 134
 -  Netzstecker + Power Supply 134 + Controller 94
Animated

1

Light Motifs
 Auslieferungsstandard
 // OHNE AC/DC
 // OHNE NETZTEIL
 // CONTROLLER ERFORDERLICH
 (ANIMATED)

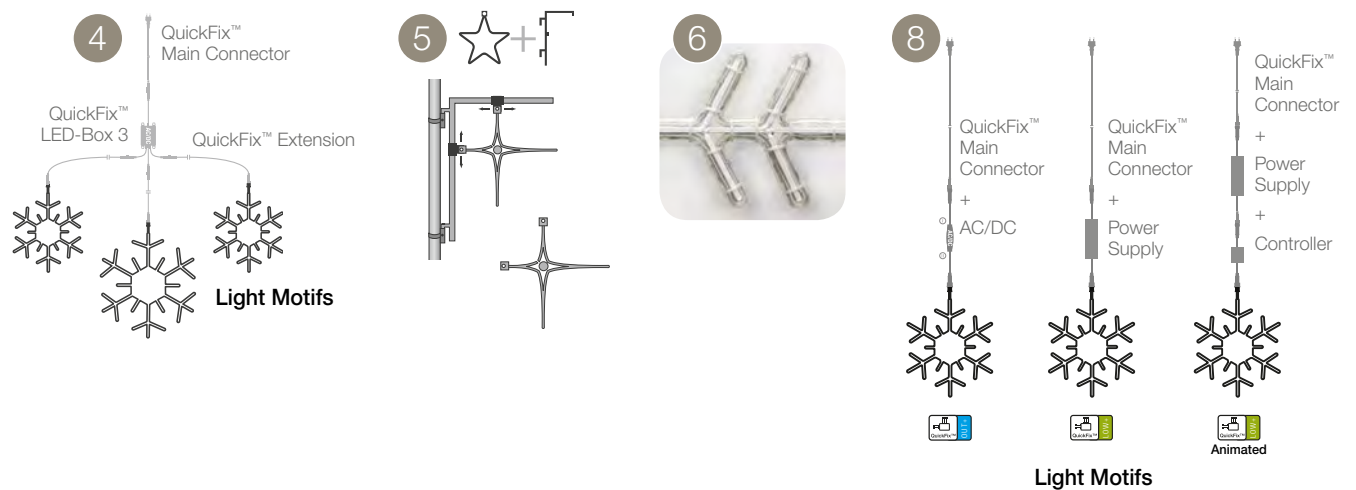
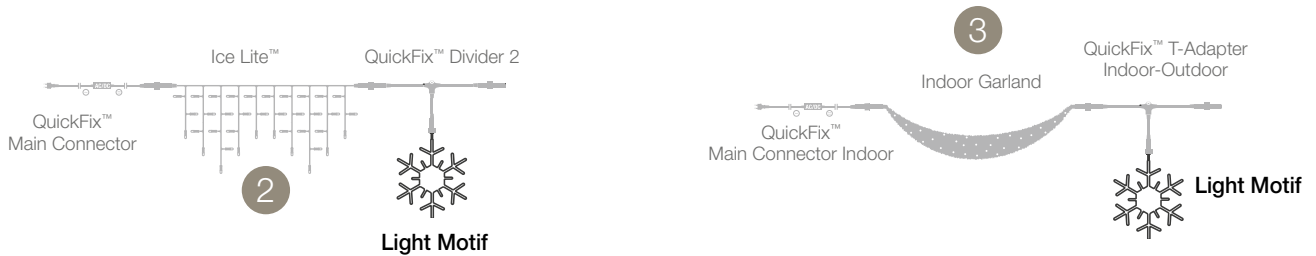

Flexibler Montagerahmen



Unsere Kleinmotive zur Hängemontage sind mit dem neuen flexiblen Rahmensystem kompatibel. Dadurch können sie als Mast- und Wandmotive eingesetzt werden.

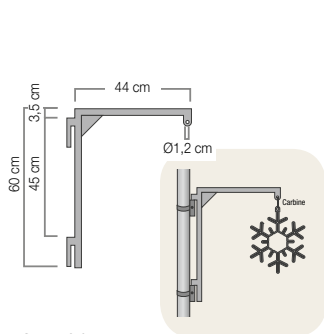

941-061

↙ ~44 x 60 cm

◇ ~0.8 kg

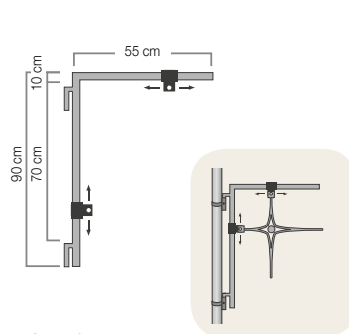

941-017

↙ ~55 x 90 cm

◇ ~1 kg

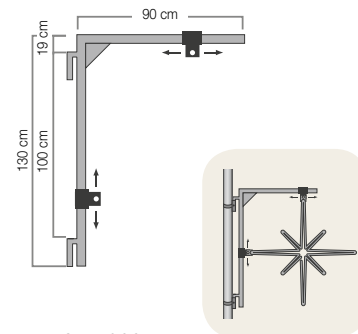

941-033

↙ ~90 x 130 cm

◇ ~1.5 kg

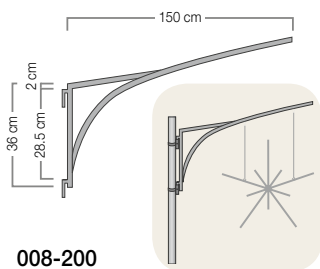

008-200

↙ ~150 x 41 cm

◇ ~2.4 kg

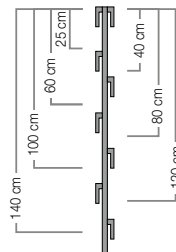

941-035

Montaglehre für Mastschelle

↙ ~151 x 10 cm



7 Zubehör

Mastmontage

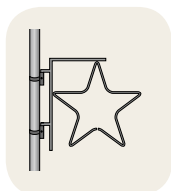

941-002

Ø 80 - 100 mm
Schlauchklemme DIN 3017-AS W4



941-003

Ø 100 - 120 mm
Schlauchklemme DIN 3017-AS W4



941-006

Halbschelle



941-738

Halbschelle mit Steckdose



Wandmontage

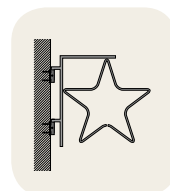

941-004

Fassadenschelle



941-005

Fassadenschelle mit Steckdose



MK ILLUMINATION
PRODUCTS

LIGHT COMPOSITIONS



Bremerhaven – Germany

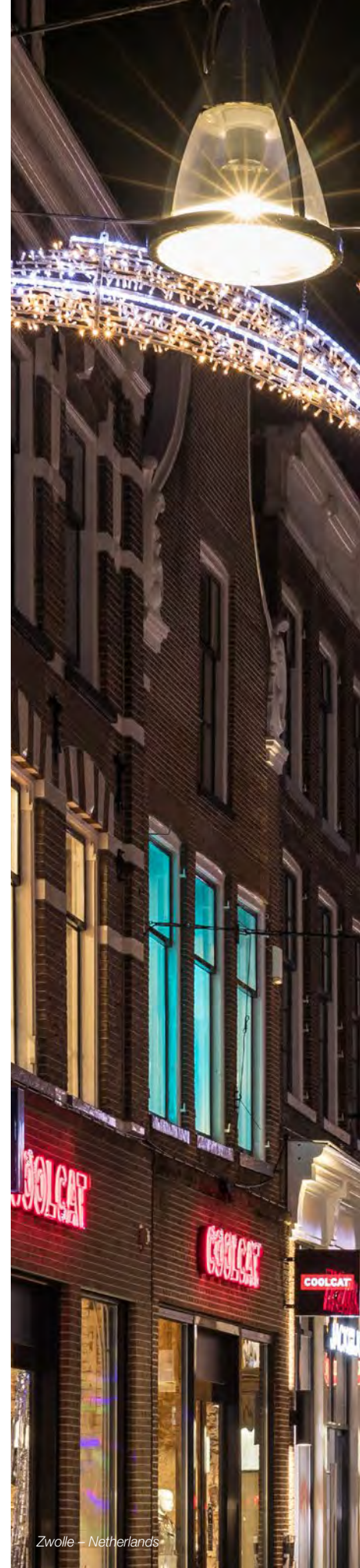

Zwolle – Netherlands

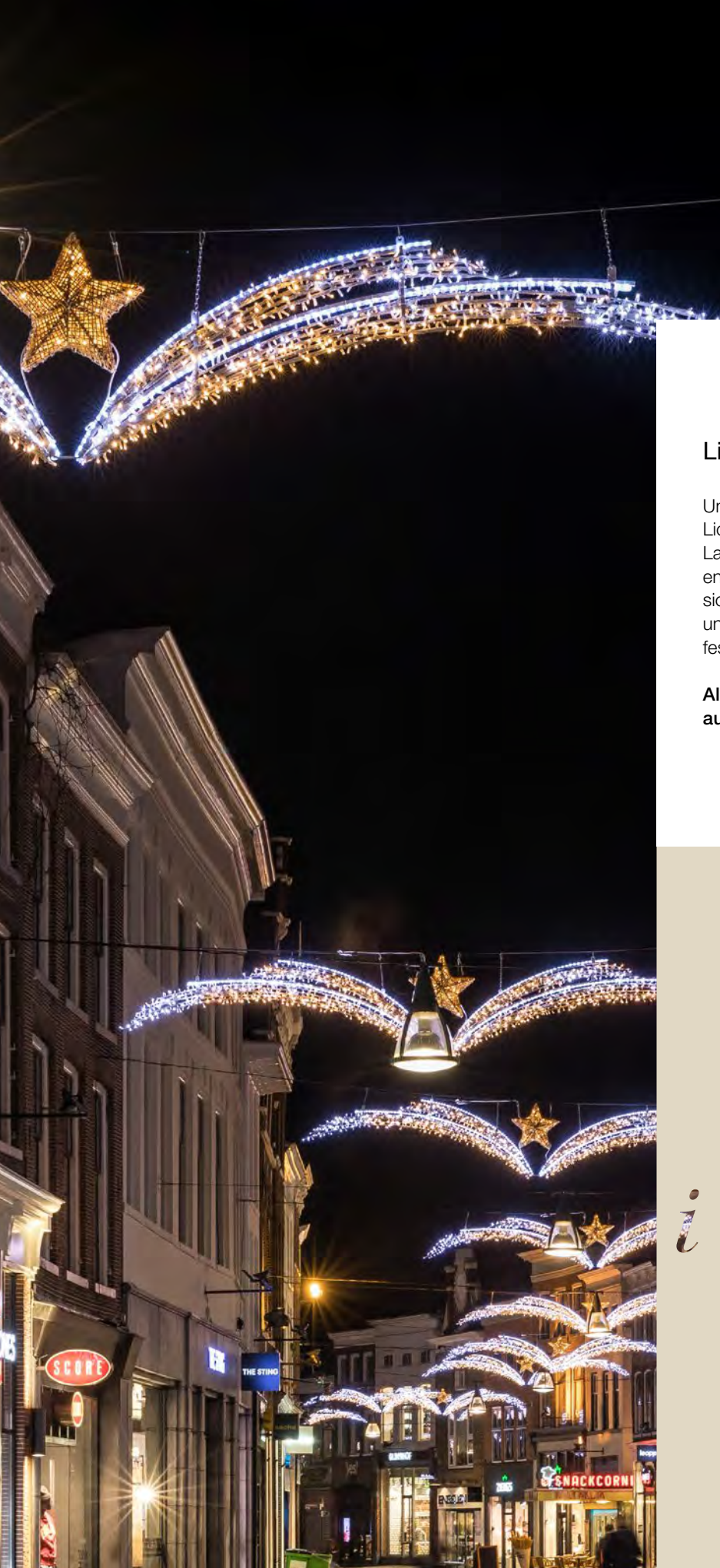

Light Compositions

Unsere beliebten zweidimensionalen Lichtmotive für Straßenüberspannungen, Laternen oder Hausfassaden mit entsprechender LED-Technologie, lassen sich wunderbar miteinander kombinieren und ergeben somit ein ausgesprochen festliches Gesamtbild.

Alle Motive werden ohne Netzstecker ausgeliefert!

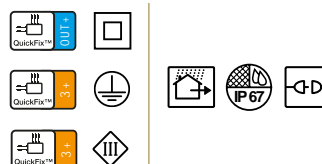

i

- // Schutzart IP67
- // Schutzklasse 1 (QF 3+)
- // Schutzklasse 2 (QF Outdoor+)
- // Schutzklasse 3 (QF Low Voltage+),
inkl. Power Supply

Jede Weihnachtsbeleuchtung
kann ein Einzelstück sein

Kreieren Sie Ihre eigene Weihnachtsbeleuchtung. Ganz nach Ihren Bedürfnissen. Das funktioniert bei MK Illumination ganz einfach. Verschiedenste Licht-Varianten, Materialien, Motive und Farben können auf unterschiedlichste Weise miteinander kombiniert werden. Somit ist jede Lichtinszenierung immer etwas Besonderes. Und wir unterstützen Sie natürlich gerne bei Ihrer Wahl.

So können aus Motiven Unikate werden:



Motiv

Motiv mit Licht (String Lite®)



Motiv mit Stoff

Motiv mit Girlande und Licht

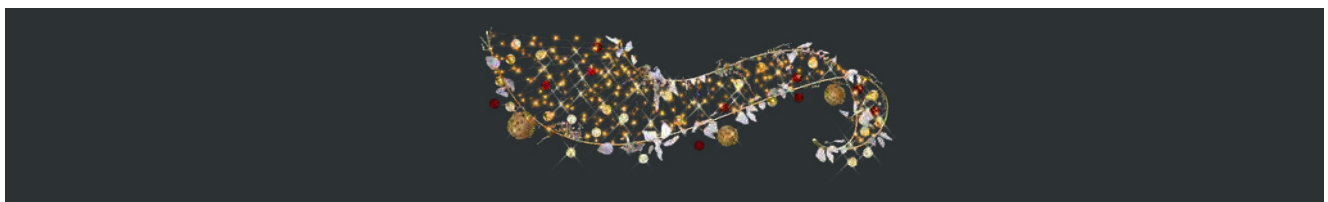

Motiv mit Dekorations-Elementen und Licht

Customized Materialien

Das Material bestimmt die Wirkung, insbesondere bei der Tagwirkung.
Das sind die beliebtesten Materialien:

Organic

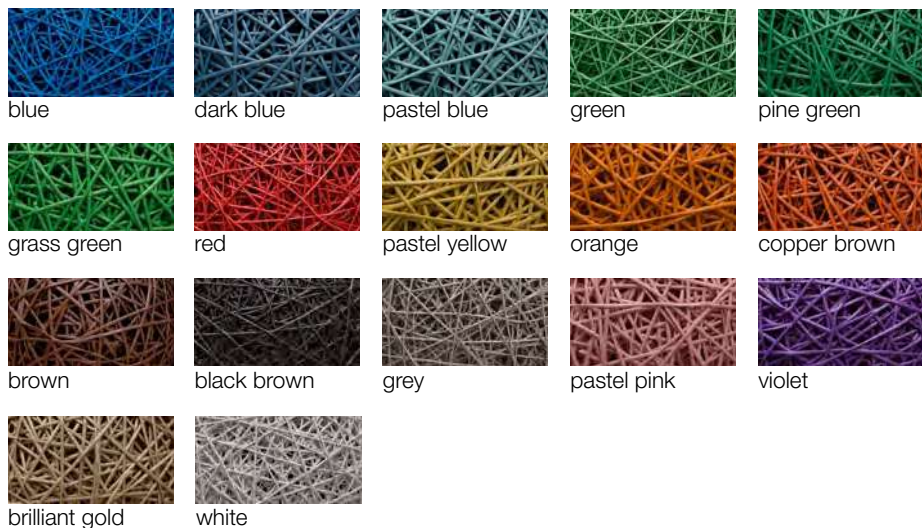

Die Fangemeinde für unsere „organischen Materialien“ wächst ständig. Vor allem wegen ihrer perfekten und unterschiedlichen Tages- und Nachtwirkung. Die Organic Materials bestehen aus 100 Prozent Biowerkstoff. Das heißt, dieses Material kann am Ende seines Lebenszyklus recycelt und stofflich wiederverwertet werden und ist somit umweltfreundlich.

Carpet



Unser Carpet Material ist überaus lichtbeständig und simuliert einen wunderbaren 3D-Effekt. Die Palette an unterschiedlichsten Farbnuancen bietet einen hohen Gestaltungs-Spielraum.

Customized Materialien

Girlanden



Festliche Girlanden – unser zeitloser Klassiker und Garant für eine feierliche und stimmungsvolle Weihnachts-Atmosphäre.

Stoffe

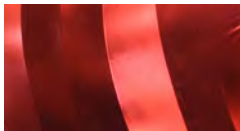

Schimmernde Stoffvarianten für die Innendekoration. Schimmerndes Gold oder leuchtendes Rot verbreiten eine besonders elegante und festliche Aura.

Customized Dekoration

Gerne drapieren unsere Kunden ihre Licht-Objekte mit zusätzlichen Dekurations-Elementen. Diese steigern den Tageslicht-Effekt besonders.

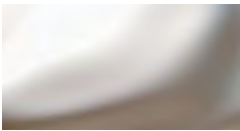

Aluminium



Holz

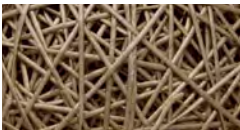

Organic



Deco Balls



Acryl



Alternative Materialien



Customized
Licht

Lichtart



Rope Light



Bulbs

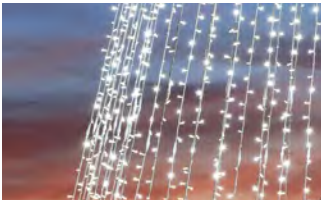

String Lite®



Drape Lite®



Ice Lite®

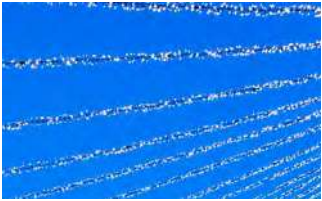

Magic String Lite®



Sowohl Lichtintensität, als auch Lichtfarbe nehmen großen Einfluss auf Ihre Licht-Inszenierung.

Lichtfarbe



warmweiß

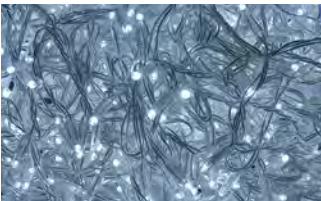

brillantweiß



färbig

Wir wünschen Ihnen viel Freude beim Kreieren Ihrer ganz persönlichen Beleuchtungs-Motive.



Night & Day
highlight



NEW

① Christmas Romance



- ① Christmas Romance 660-174 / ~ 500 x 80 x 35 cm / ~ 16 kg / ~ 84 W / LED LED ■ ■ / ☆ T-6 3D  
- 660-198 / ~ 500 x 80 x 35 cm / ~ 16 kg / ~ 84 W / LED LED ■ ■ / ☆ T-6 3D  
- 620-060 / ~ 300 x 80 x 35 cm / ~ 12 kg / ~ 63 W / LED LED ■ ■ / ☆ T-4 3D  
- 660-197 / ~ 300 x 80 x 35 cm / ~ 12 kg / ~ 63 W / LED LED ■ ■ / ☆ T-4 3D  

Night & Day
across street



① Swing Angel 3D



② Firework

① Swing Angel 3D 660-001 / ~ 425 x 145 x 50 cm / ~ 20 kg / ~ 147 W / LED LED ■ / ☆ T-3 3D 

② Firework 660-165 / ~ 550 x 95 x 20 cm / ~ 21 kg / ~ 175 W / LED LED ■ / ☆ T-8 3D 



③ Angel of Light

③ Angel of Light

660-170 / ~ 580 x 243 x 39 cm / ~ 21 kg / ~ 164 W / LED LED ■ ~ / ☆ T-6 3D

Frame-it
across street







① Star Frame













② Ball Frame



③ Heart Frame

① Star Frame 660-164 / ~ 202 x 190 x 36 cm / ~ 12 kg / ~ 88 W / LED   / ☆ T-2   

② Ball Frame 660-163 / ~ 207 x 202 x 78 cm / ~ 14 kg / ~ 84 W / LED   / ☆ T-2   

③ Heart Frame 660-162 / ~ 222 x 202 cm / ~ 11 kg / ~ 91 W / LED    / ☆ T-2   





+



Cosmic Wave
Page 300

④ Creative Frame

④ Creative Frame

660-177 / ~ 313 x 235 x 36 cm / ~ 18 kg / ~ 147 W / LED ■ ~ / ☆ T-3 3D  

Night & Day

across street / pole & lamp



① Swing Glamour











Organic Ball
Organic Line on page 172-195



② Christmas Ball



① Swing Glamour 660-002 / ~ 219 x 65 cm / ~ 5 kg / ~ 35 W /   / ☆ T-2  

② Christmas Ball 660-196 / ~ 507 x 170 x 60 cm / ~ 25 kg / ~ 168 W /    / ☆ T-6+1  





① Christmas Romance Pole







② Angel of Light Pole



③ Firework Pole

① Christmas Romance 660-149 / ~ 74 x 217 x 30 cm / ~ 7 kg / ~ 49 W / LED LED ■ ■ / ☆ P-3, 100 cm 3D  

② Angel of Light Pole 660-004 / ~ 245 x 140 x 39 cm / ~ 12 kg / ~ 63 W / LED ✨ ■ ~ / ☆ P-2, 120 cm 3D  

③ Firework Pole 660-158 / ~ 81 x 267 cm / ~ 11 kg / ~ 84 W / LED LED ~ / ☆ P-3, 100 cm  



A sketch of your lamp is required when ordering!

Night & Day

pole & lamp





① Celebration Pentor



② Celebration Bell



③ Celebration Comet

- ① Celebration Pentor 660-005 / ~ 98 x 200 x 25 cm / ~ 7 kg / ~ 35 W / LED LED ■ / ☆ P-2, 80 cm 3D 
- ② Celebration Bell 660-006 / ~ 120 x 190 x 25 cm / ~ 10 kg / ~ 53 W / LED LED ■ / ☆ P-2, 120 cm 3D 
- ③ Celebration Comet 660-007 / ~ 88 x 233 x 25 cm / ~ 6 kg / ~ 28 W / LED LED ■ / ☆ P-2, 160 cm 3D 



A sketch of your lamp is required when ordering!



Essen – Germany



Zwolle – Netherlands



Zwolle – Netherlands



LIGHT COMPOSITIONS

Crystal Dance

highlight









NEW

① Crystal Branch



① Crystal Branch

660-190 / ~ 250 x 76 x 17 cm / ~ 8 kg / ~ 25 W / LED     T-3  





LIGHT COMPOSITIONS

Crystal Dance

across street



① Christmas Smooth

① Christmas Smooth 660-166 / ~ 507 x 70 x 39 cm / ~ 24 kg / ~ 105 W / LED   / ☆ T-6   



Organic Ball
Organic Line on page 172-195

② Organic Ribbon

② Organic Ribbon 660-220 / ~ 350 x 50 x 50 cm / ~ 10.5 kg / ~ 49 W / LED ■ ~ / ☆ T-4 3D 

Crystal Dance







pole & lamp











① Christmas Smooth Pole

② Crystal Branch Pole

③ Glimmer Pole

① Christmas Smooth Pole 660-159 / ~ 62 x 202 x 17 cm / ~ 8 kg / ~ 42 W /     / ☆ P-3, 80 cm  

② Crystal Branch Pole 660-189 / ~ 90 x 248 x 17 cm / ~ 10 kg / ~ 25 W /     / ☆ P-2, 80 cm  

③ Glimmer Pole 660-191 / ~ 50 x 180 cm / ~ 3.5 kg / ~ 14 W /   / ☆ P-2, 100 cm 



A sketch of your lamp is required when ordering!



Wolfsberg – Austria



Symbol Picture



Symbol Picture



Celebration
highlight



① Violin



① Violin 660-014 / ~ 104 x 237 cm / ~ 8 kg / ~ 70 W / LED LED / ☆ P-2, 120 cm

Celebration
across street



NEW

① Christmas Sterling

① Christmas Sterling 660-185 / ~ 530 x 100 cm / ~ 15 kg / ~ 133 W / LED LED / ☆ T-6



② Crown Princess

② Crown Princess

- ⓐ 660-145 / ~498 x 80 cm / ~ 13 kg / ~ 140 W / LED LED / ☆ T-7
- ⓑ 660-146 / ~498 x 80 cm / ~ 13 kg / ~ 140 W / LED / ☆ T-7

Celebration

pole & lamp



NEW



NEW





NEW

① Christmas Sterling Pole

② Princess Pole

③ Geometric Fan

① Christmas Sterling Pole 660-188 / ~ 80 x 240 cm / ~ 9 kg / ~ 77 W / LED LED / ☆ P-3, 100 cm 

② Princess Pole 660-187 / ~ 96 x 153 cm / ~ 9 kg / ~ 74 W / LED LED / ☆ P-2, 100 cm 

③ Geometric Fan 660-186 / ~ 55 x 143 cm / ~ 3.5 kg / ~ 32 W / LED LED / ☆ P-2, 80 cm 



A sketch of your lamp is required when ordering!



Fünf Höfe, München – Germany



Világítás – Hungary



Symbol Picture



Nordic
highlight



① Nordic Sun



- ① Nordic Sun 660-018 / ~ 120 x 120 x 39 cm / ~ 7.5 kg / ~ 53 W / LED LED / / ☆ T-2 3D 3D
660-019 / ~ 120 x 120 x 39 cm / ~ 7.5 kg / ~ 53 W / LED / / ☆ T-2 3D 3D
660-020 / ~ 124 x 126 x 39 cm / ~ 9 kg / ~ 53 W / LED LED / ☆ P-2, 100 cm 3D 3D
660-021 / ~ 124 x 126 x 39 cm / ~ 9 kg / ~ 53 W / LED / / ☆ P-2, 100 cm 3D 3D

LIGHT COMPOSITIONS

Nordic across street





Option

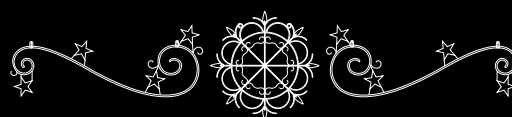

① Nordic Breeze



Option

② Nordic Wind Play

- ① Nordic Breeze 660-022 / ~ 56 x 241 cm / ~ 4 kg / ~ 25 W / LED LED / ☆ T-2 
 660-023 / ~ 56 x 241 cm / ~ 4 kg / ~ 25 W / LED / ☆ T-2 

- ② Nordic Wind Play 660-203 / ~ 200 x 75 cm / ~ 4.5 kg / ~ 46 W / LED / ☆ T-2 
 660-202 / ~ 75 x 200 cm / ~ 5.5 kg / ~ 46 W / LED / ☆ P-2,140 cm 

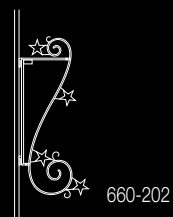

660-202

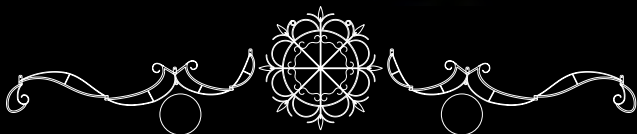





Option



③ Nordic Light



④ Nordic Rose

③ Nordic Light



660-026 / ~ 244 x 61 x 39 cm / ~ 6 kg / ~ 42 W / LED ■ / ☆ T-3 3D  



660-027 / ~ 244 x 61 x 39 cm / ~ 6 kg / ~ 42 W / LED ■ / ☆ T-3 3D  

660-028 / ~ 81 x 244 x 39 cm / ~ 7.5 kg / ~ 42 W / LED ■ / ☆ P-2, 160 cm 3D  

660-029 / ~ 81 x 244 x 39 cm / ~ 7.5 kg / ~ 42 W / LED ■ / ☆ P-2, 160 cm 3D  

④ Nordic Rose

660-030 / ~ 120 x 120 x 12 cm / ~ 7 kg / ~ 53 W / LED ■ / ☆ T-2 3D  

660-031 / ~ 126 x 124 x 12 cm / ~ 7.5 kg / ~ 53 W / LED ■ / ☆ P-2, 100 cm 3D  



660-028 / 660-029

Nordic
pole & lamp



NEW

① Nordic Swing



NEW

② Nordic Rose Bush







Option 660-035





③ Nordic Sparkle



① Nordic Swing

660-200 / ~ 100 x 350 x 10 cm / ~ 11 kg / ~ 98 W / LED LED ■ ■ / ☆ P-3, 140 cm   

660-199 / ~ 100 x 350 x 10 cm / ~ 11 kg / ~ 98 W / LED ■ / ☆ P-3, 140 cm  



② Nordic Rose Bush



660-201 / ~ 123 x 342 x 12 cm / ~ 12 kg / ~ 81 W / LED LED ■ ■ / ☆ P-3, 100 cm  



660-035 / ~ 342 x 120 x 12 cm / ~ 10 kg / ~ 63 W / LED LED ■ ■ / ☆ T-4  

③ Nordic Sparkle

660-036 / ~ 105 x 105 x 10 cm / ~ 5 kg / ~ 28 W / LED LED ■ ■ / ☆ P-2, 80 cm  

660-037 / ~ 105 x 105 x 10 cm / ~ 5 kg / ~ 28 W / LED ■ / ☆ P-2, 80 cm  

660-038 / ~ 80 x 80 x 10 cm / ~ 3.5 kg / ~ 28 W / LED LED ■ ■ / ☆ T-2  

660-039 / ~ 80 x 80 x 10 cm / ~ 3.5 kg / ~ 28 W / LED ■ ■ / ☆ T-2  



A sketch of your lamp is required when ordering!



Gothenburg – Sweden



Gothenburg – Sweden



Neu Rum – Austria



Red Passion
highlight



① Christmas Ball Grid



① Christmas Ball Grid 660-045 / ~ 512 x 125 cm / ~ 15 kg / ~ 112 W / LED LED / ☆ T-4

LIGHT COMPOSITIONS

Red Passion

across street

NEW











① Star Dust Red



Option

② Christmas Star

① Star Dust Red 660-214 / ~ 270 x 125 cm / ~ 10 kg / ~ 28 W / LED /   / ☆ T-3  

② Christmas Star 660-043 / ~ 234 x 69 cm / ~ 5 kg / ~ 39 W / LED /   / ☆ T-3  



+



Option

Organic Star Dust (2D)
Organic Line on page 172-195

③ Christmas Duet

③ Christmas Duet 660-044 / ~ 270 x 50 cm / ~ 7 kg / ~ 42 W / LED / ~ / ☆ T-2 

Red Passion

pole & lamp



① Glittering Eve



② Ornament Pentor



NEW

③ Heart Beat

① Glittering Eve

660-112 / ~ 85 x 225 cm / ~ 7 kg / ~ 46 W / LED / P-2, 160 cm

② Ornament Pentor

660-047 / ~ 60 x 246 cm / ~ 6 kg / ~ 28 W / LED / P-2, 120 cm

③ Heart Beat

660-213 / ~ 107 x 118 x 35 cm / ~ 10.5 kg / ~ 56 W / LED / P-2, 60 cm



A sketch of your lamp is required when ordering!



Leidschendam - Netherlands



Symbol Picture



Hengelo - Netherlands



Stardust
highlight



① Moment of Glory



① Moment of Glory 660-172 / ~ 503 x 207 cm / ~ 19 kg / ~ 119 W / LED LED / ☆ T-5

Stardust
across street



① Cassiopeia Rise

② Star of Bethlehem

① Cassiopeia Rise 660-049 / ~ 412 x 107 cm / ~ 9 kg / ~ 84 W / LED LED / ☆ T-4

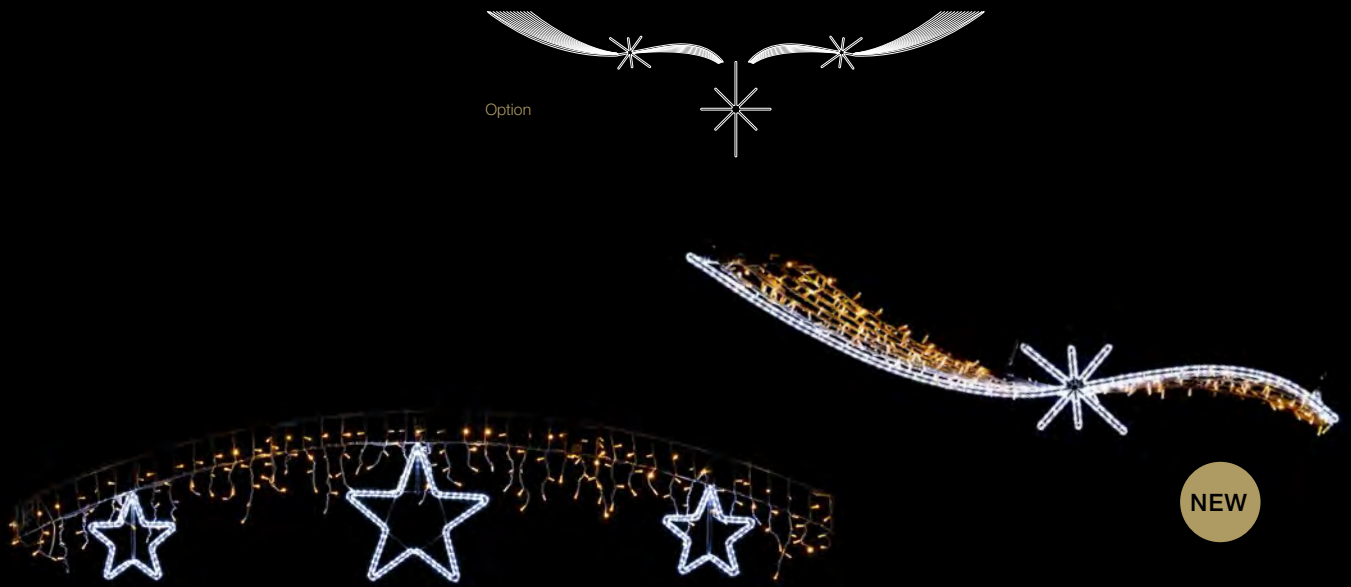

② Star of Bethlehem 660-050 / ~ 180 x 50 cm / ~ 2.4 kg / ~ 25 W / LED LED / ☆ T-2

660-051 / ~ 65 x 180 cm / ~ 3.5 kg / ~ 25 W / LED LED / ☆ P-2, 100 cm



③ Stardust Pentor

④ Polaris Swing

- ③ Stardust Pentor 660-052 / ~ 400 x 84 cm / ~ 8.5 kg / ~ 53 W / LED LED / ☆ T-3 
- 660-216 / ~ 400 x 84 cm / ~ 8.5 kg / ~ 53 W / LED LED / ☆ T-3 
- ④ Polaris Swing 660-215 / ~ 240 x 60 cm / ~ 5 kg / ~ 49 W / LED LED / ☆ T-3 

Stardust

pole & lamp



① Moment of Glory Pole







② Cassiopeia Pole



③ Vienna

① Moment of Glory Pole 660-168 / ~ 133 x 256 cm / ~ 8 kg / ~ 53 W / LED LED / ☆ P-3, 100 cm 

② Cassiopeia Pole 660-055 / ~ 110 x 250 cm / ~ 5 kg / ~ 42 W / LED / ☆ P-2, 60 cm  

③ Vienna 660-184 / ~ 50 x 160 x 50 cm / ~ 5 kg / ~ 46 W / LED / ☆ P-2, 60 cm  



A sketch of your lamp is required when ordering!



Symbol Picture



Linköping – Sweden



Uelzen - Germany



Pure Light
highlight



① Drape Sail



① Drape Sail

660-056 / ~ 85 x 235 cm / ~ 8 kg / ~ 56 W / LED LED / ☆ P-2, 120 cm

Pure Light
across street



NEW



Organic Pine

Organic Line on page 172-195

① Piano Dance

① Piano Dance

660-058 / ~ 263 x 93 cm / ~ 5 kg / ~ 46 W / LED / ☆ T-2



② Pattern Flow

② Pattern Flow

660-169 / ~ 343 x 105 cm / ~ 6 kg / ~ 44 W / LED LED / ☆ T-5 

Pure Light
pole & lamp



① Candelino Star



NEW



② Pole Dress

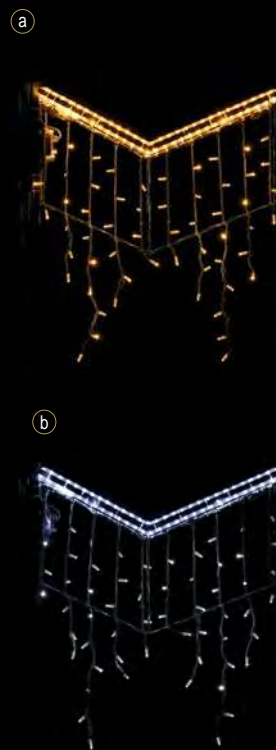

③ Pattern Flow Pole

① Candelino Star 660-059 / ~ 120 x 320 x 120 cm / ~ 21 kg / ~ 98 W / LED / / P-4

② Pole Dress 660-212 / ~ 107 x 203 x 107 cm / ~ 20 kg / ~ 60 W / LED / / P-4

③ Pattern Flow Pole ^a 660-161 / ~ 90 x 110 cm / ~ 2 kg / ~ 11 W / LED / P-2, 40 cm

^b 660-160 / ~ 90 x 110 cm / ~ 2 kg / ~ 11 W / LED / P-2, 40 cm



A sketch of your lamp is required when ordering!



Brixen - Italy



Symbol Picture



Stockholm - Sweden



LIGHT COMPOSITIONS

Christmas Cheer
highlight



① Magic Ribbon Gold



① Magic Ribbon Gold 660-133 / ~ 450 x 82 x 22 cm / ~14 kg / ~ 105 W / LED LED ■ ~ / ☆ T-5 3D

LIGHT COMPOSITIONS

Christmas Cheer across street



① Pegasus Cheer



② Cheer Flake

① Pegasus Cheer 660-062 / ~ 365 x 110 cm / ~ 13.5 kg / ~ 126 W / LED ■ / ☆ T-4 

② Cheer Flake 660-175 / ~ 400 x 80 cm / ~ 15 kg / ~ 81 W / LED ■ ■ ■ ■ / ☆ T-5 



③ Magic Ribbon



③ Magic Ribbon

660-063 / ~ 450 x 82 x 22 cm / ~ 11 kg / 36 V / ~ 86 W /  / ☆ T-5 / ϕ /  

Christmas Cheer

pole & lamp





① Pegasus Cheer Pole





② Cheer Flake Pole



③ Drape Gold

① Pegasus Cheer Pole 660-064 / ~ 105 x 249 cm / ~ 6 kg / ~ 49 W / LED ■ / ☆ P-2, 60 cm  

② Cheer Flake Pole 660-065 / ~ 85 x 112 cm / ~ 6 kg / ~ 39 W / LED LED ■ ■ / ☆ P-2, 80 cm 

③ Drape Gold 660-066 / ~ 94 x 220 cm / ~ 5 kg / ~ 39 W / LED LED / ☆ P-3, 80 cm 



A sketch of your lamp is required when ordering!



Berghem - Netherlands



Symbol Picture



Symbol Picture





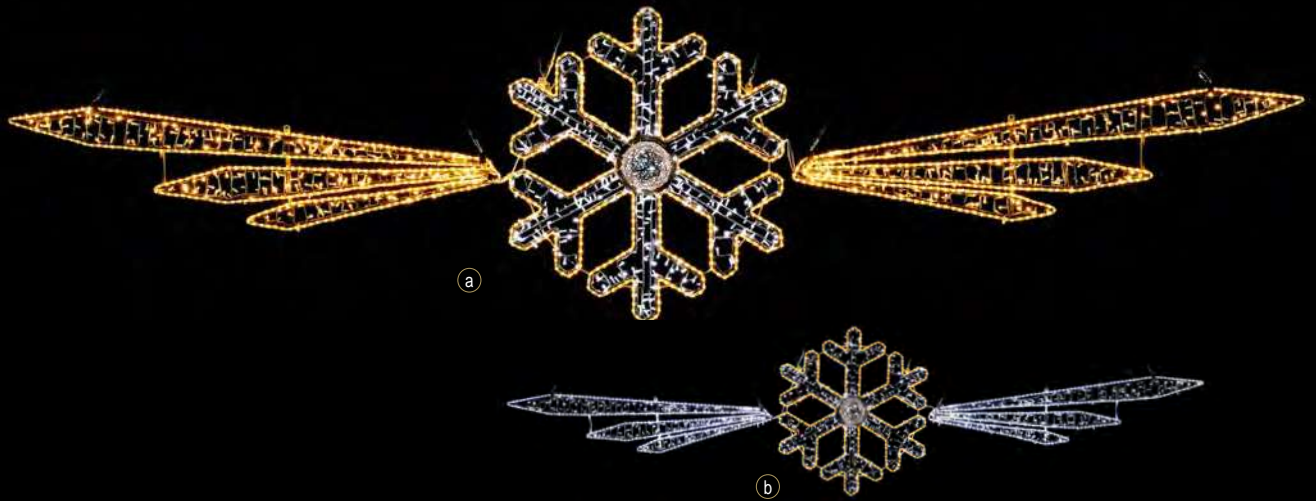

Winter
highlight







① Ice Wing



① Ice Wing

① a 660-171 / ~586 x 141 x 22 cm / ~ 19 kg / ~ 238 W / LED LED    / ☆ T-8  

① b 660-167 / ~586 x 141 x 22 cm / ~ 19 kg / ~ 238 W / LED LED    / ☆ T-8  



Winter
flake





① East Star



② North Star

① East Star



660-067 / ~ 124 x 124 x 22 cm / ~ 5.2 kg / ~ 56 W / LED LED / ☆ T-2 3D  

660-068 / ~ 124 x 124 x 22 cm / ~ 5.2 kg / ~ 56 W / LED / ☆ T-2 3D  



660-069 / ~ 110 x 126 x 22 cm / ~ 6 kg / ~ 56 W / LED LED / ☆ P-2, 100 cm 3D  



660-070 / ~ 110 x 126 x 22 cm / ~ 6 kg / ~ 56 W / LED / ☆ P-2, 100 cm 3D  

② North Star

660-071 / ~ 142 x 142 x 22cm / ~ 7.5 kg / ~ 84 W / LED LED / ☆ T-2 3D  

660-072 / ~ 142 x 142 x 22cm / ~ 7.5 kg / ~ 84 W / LED / ☆ T-2 3D  

660-073 / ~ 147 x 147 x 22cm / ~ 8.3 kg / ~ 84 W / LED LED / ☆ P-2, 100 cm 3D  

660-074 / ~ 147 x 147 x 22cm / ~ 8.3 kg / ~ 84 W / LED / ☆ P-2, 100 cm 3D  



③ Winter Flake



④ Two-tone Flake

③ Winter Flake

660-077 / ~ 135 x 135 cm / ~ 8 kg / ~ 88 W / LED / ☆ T-2

660-078 / ~ 140 x 135 cm / ~ 11 kg / ~ 88 W / LED / ☆ P-2, 120 cm

660-079 / ~ 140 x 135 cm / ~ 11 kg / ~ 88 W / LED / ☆ P-2, 120 cm

660-080 / ~ 135 x 135 cm / ~ 8 kg / ~ 88 W / LED / ☆ T-2

④ Two-tone Flake

660-173 / ~ 468 x 130 x 39 cm / ~ 29 kg / ~ 182 W / LED LED / ☆ T-5 3D

Winter
across street



① Winter Wing

① Winter Wing



① 660-075 / ~ 500 x 120 cm / ~ 16 kg / ~ 172 W / LED LED / ☆ T-6 

② 660-076 / ~ 500 x 120 cm / ~ 16 kg / ~ 154 W / LED LED / ☆ T-6 



③ Starry Sky

③ Starry Sky

① 660-157 / ~500 x 138 cm / ~ 21 kg / ~ 98 W / LED   T-5 

② 660-156 / ~500 x 138 cm / ~ 21 kg / ~ 98 W / LED   T-5 

LIGHT COMPOSITIONS

Winter pole & lamp







① Winter Pole Wing

② Ice Wings Pole



③ Starry Sky Pole



① Winter Pole Wing

Ⓐ 660-081 / ~ 90 x 220 cm / ~ 8 kg / ~ 67 W / LED / ☆ P-3, 80 cm  



Ⓑ 660-082 / ~ 90 x 220 cm / ~ 8 kg / ~ 60 W / LED / ☆ P-3, 80 cm  



② Ice Wings Pole

Ⓐ 660-147 / ~ 64 x 294 cm / ~ 8 kg / ~81 W / LED / ~ / ☆ P-3, 100 cm  

Ⓑ 660-148 / ~ 64 x 294 cm / ~ 8 kg / ~81 W / LED / ~ / ☆ P-3, 100 cm  

③ Starry Sky Pole

Ⓐ 660-143 / ~ 124 x 242 cm / ~ 8 kg / ~32 W / LED / ~ / ☆ P-2, 60 cm  

Ⓑ 660-144 / ~ 124 x 242 cm / ~ 8 kg / ~32 W / LED / ~ / ☆ P-2, 60 cm  



A sketch of your lamp is required when ordering!



Ede - Netherlands



Symbol Picture



Symbol Picture



LIGHT COMPOSITIONS

DualColour highlight

PRE
ANIMATED

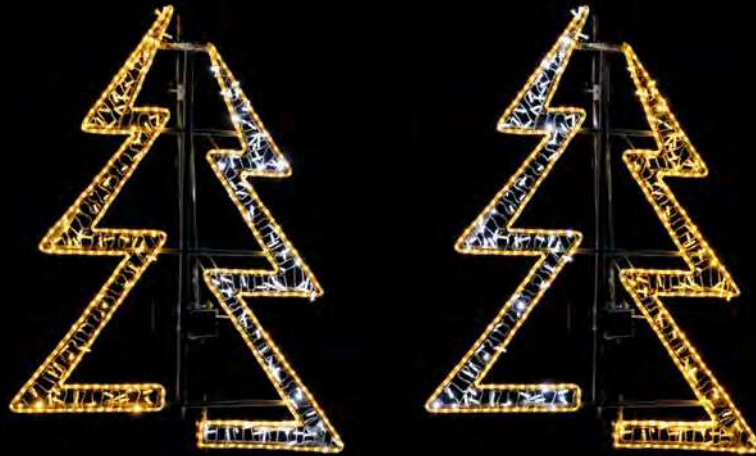

① Lightning Bolt



① Lightning Bolt 660-181 / ~118 x 156 cm / ~ 7 kg / 36 V / ~ 20 W / LED LED / ☆ P-2, 100 cm / Ø / 

LIGHT COMPOSITIONS

DualColour across street

PRE
ANIMATED



NEW



① Polaris Curtain



NEW



② Ice Flower

① Polaris Curtain 660-193 / ~ 418 x 162 cm / ~ 17 kg / 36 V / ~ 45 W / LED LED / ☆ T-5 / ⌀ /

② Ice Flower 660-192 / ~ 208 x 240 cm / ~ 12 kg / 36 V / ~ 44 W / LED LED / ☆ T-2 / ⌀ /

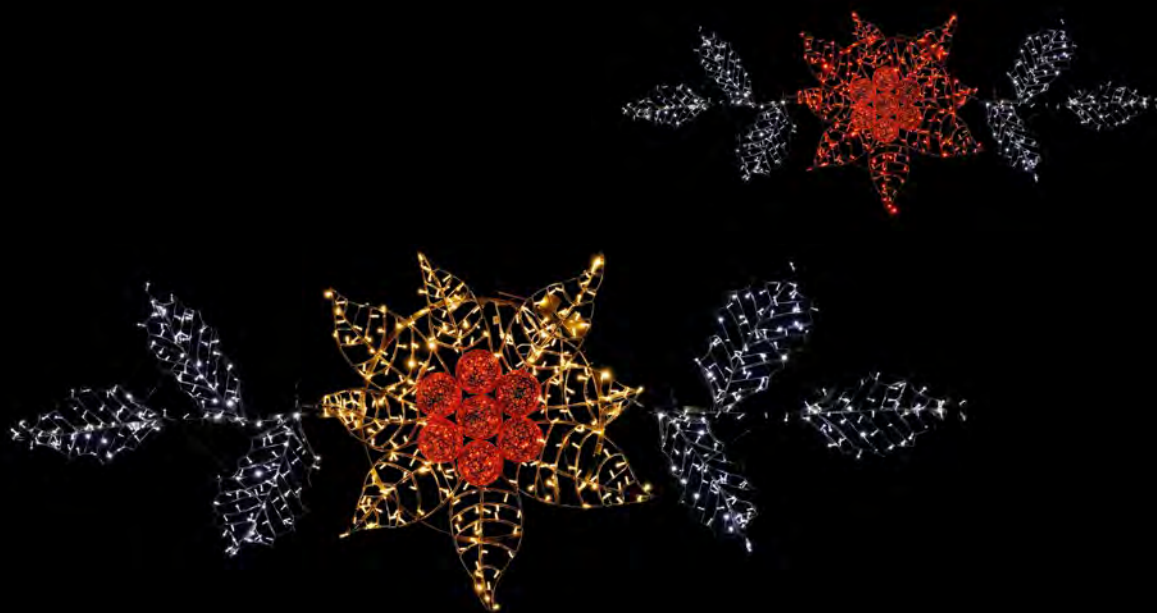

③ Winter Rose

③ Winter Rose 660-182 / ~ 465 x 180 x 22 cm / ~ 23 kg / 36 V / ~ 63 W / LED LED LED / ~ / ☆ T-4 / Ø / 30

DualColour
pole & lamp

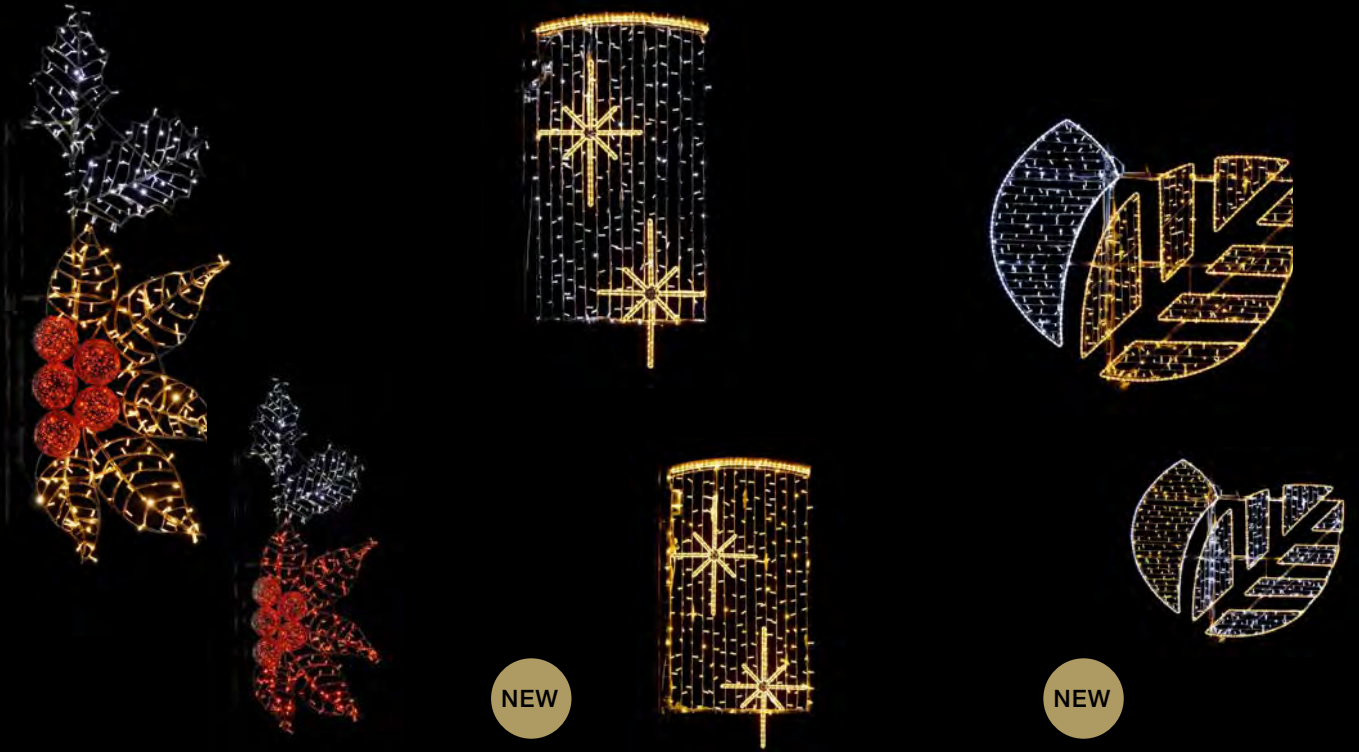

① Winter Rose

② Polaris Dual Pole

② Winter Leaf

- ① Winter Rose Pole 660-183 / ~ 106 x 273 x 22 cm / ~ 12 kg / 36 V / ~ 43 W / / P-3, 80 cm / /
- ② Polaris Dual Pole 660-194 / ~ 98 x 198 cm / ~ 8 kg / 36 V / ~ 27 W / / P-2, 120 cm /
- ② Winter Leaf 660-195 / ~ 215 x 190 cm / ~ 13 kg / 36 V / ~ 41 W / / P-3, 80 cm /

A sketch of your lamp is required when ordering!



Symbol Picture



Symbol Picture



Germering – Germany



Johannesburg – South Africa



Zwolle – Netherlands



Bernau – Germany



Mechelen – Belgium



Weer – Austria





① Swing Duet

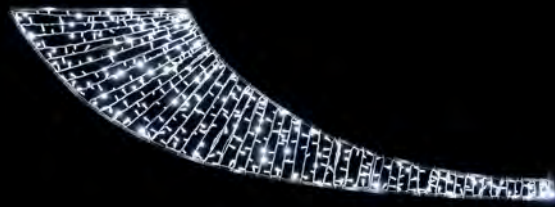

② Cosmic Wave



③ Jazz Dance

① Swing Duet	660-083 / ~ 270 x 44 cm / ~ 6 kg / ~ 70 W /    / ☆ T-2  
② Cosmic Wave	660-084 / ~ 233 x 60 cm / ~ 3 kg / ~ 25 W /   / ☆ T-2  
③ Jazz Dance	660-085 / ~ 270 x 136 cm / ~ 4 kg / ~ 35 W /   / ☆ T-3  

Across Street



① Swing Baroque



② Winter Swing



③ Ice Star Sky

-
- ① Swing Baroque 660-086 / ~ 280 x 64 cm / ~ 6 kg / ~ 56 W / LED LED / ☆ T-2 
- ② Winter Swing 660-087 / ~ 520 x 80 cm / ~ 7 kg / ~ 49 W / LED / ☆ T-4 
- ③ Ice Star Sky 660-088 / ~ 520 x 50 cm / ~ 13 kg / ~ 102 W / LED LED / ☆ T-5 











① Pegasus Sky



② Cassiopeia Sky



③ Polaris Sky

① Pegasus Sky	660-089 / ~ 525 x 140 cm / ~ 20 kg / ~ 165 W / LED LED / ☆ T-3  
	660-090 / ~ 525 x 140 cm / ~ 20 kg / ~ 165 W / LED LED / ☆ T-3  
② Cassiopeia Sky	660-091 / ~ 515 x 140 cm / ~ 18 kg / ~ 133 W / LED LED / ☆ T-4  
③ Polaris Sky	660-092 / ~ 400 x 135 cm / ~ 12 kg / ~ 81 W / LED LED / ☆ T-3  
	660-093 / ~ 400 x 135 cm / ~ 12 kg / ~ 81 W / LED / ☆ T-3 

Pole





① Swinging Bell



② Comet Adele



③ Christmas Curtain

-
- ① Swinging Bell 660-134 / ~ 570 x 145 x 120 cm / ~ 33 kg / ~ 203 W / LED LED ■ ~ / ☆ T-7 **3D** 
 - ② Comet Adele 660-139 / ~ 555 x 215 cm / ~ 29 kg / ~ 182 W / LED LED ~ / ☆ T-6 
 - ③ Christmas Curtain 660-141 / ~ 591 x 183 x 40 cm / ~ 22 kg / ~ 105 W / LED ■ ~ / ☆ T-5 **3D** 



① Sheraton Star



② Centauri Star



③ Cassiopeia Organic



④ Pegasus Pole

- ① Sheraton Star 660-152 / ~ 85 x 162 cm / ~ 4 kg / ~ 39 W / / P-2, 80 cm
- ② Centauri Star 660-136 / ~ 96 x 294 cm / ~ 9 kg / ~ 63 W / / P-3, 80 cm
- ③ Cassiopeia Organic 660-151 / ~ 109 x 246 x 20 cm / ~ 6 kg / ~ 39 W / / P-2, 60 cm
- ④ Pegasus Pole 660-094 / ~ 95 x 185 cm / ~ 5 kg / ~ 39 W / / P-2, 60 cm
- 660-095 / ~ 95 x 185 cm / ~ 5 kg / ~ 39 W / / P-2, 60 cm



A sketch of your lamp is required when ordering!

Pole



① Twinkle Star



② Calligraphy Tree



③ Swinging Bell Pole



④ Lovely Heart



- ① Twinkle Star 660-153 / ~ 67 x 234 cm / ~ 6 kg / ~ 49 W / LED LED / ☆ P-3, 100 cm
- ② Calligraphy Tree 660-137 / ~ 122 x 238 cm / ~ 7 kg / ~ 49 W / LED / ☆ P-3, 80 cm
- 660-217 / ~ 122 x 238 cm / ~ 7 kg / 36 V / ~ 26 W / LED / ☆ P-3, 80 cm
- ③ Swinging Bell Pole 660-135 / ~ 145 x 280 x 22 cm / ~ 11 kg / ~ 87 W / LED LED / ☆ P-3, 100 cm
- ④ Lovely Heart 660-138 / ~ 120 x 124 cm / ~ 5 kg / ~ 42 W / LED / ☆ P-2, 60 cm
- 660-209 / ~ 120 x 124 cm / ~ 5 kg / 36 V / ~ 24 W / LED / ☆ P-2, 60 cm



① Harp











② Celebration Arch



③ Ice Star Pole



④ Flamenco

- ① Harp 660-096 / ~ 113 x 230 cm / ~ 5 kg / ~ 53 W / LED LED / ☆ P-2, 140 cm  
- ② Celebration Arch 660-097 / ~ 99 x 278 x 40 cm / ~ 13 kg / ~ 53 W / LED LED ■ / ☆ P-3, 100 cm  
- ③ Ice Star Pole 660-098 / ~ 98 x 283 cm / ~ 10 kg / ~ 56 W / LED LED / ☆ P-3, 80 cm 
- ④ Flamenco 660-099 / ~ 94 x 246 cm / ~ 7 kg / ~ 56 W / LED LED / ☆ P-2, 60 cm   



A sketch of your lamp is required when ordering!

Pole



① Angel in Love



② Lisbon











③ Tango



④ Chamonix



① Angel in Love	660-100 / ~ 118 x 217 cm / ~ 8 kg / ~ 60 W / LED LED / ✨ / ☆ P-2, 120 cm  
② Lisbon	660-154 / ~ 74 x 185 cm / ~ 3 kg / ~ 28 W / LED LED / ✨ P-2, 40 cm  
③ Tango	660-101 / ~ 135 x 250 cm / ~ 6 kg / ~ 32 W / LED LED / ✨ P-2, 60 cm  
④ Chamonix	660-142 / ~ 131 x 247 cm / ~ 6 kg / ~ 42 W / LED LED / ✨ P-2, 60 cm  



① New York



NEW

② Trinity Star







③ Paris





NEW

④ Angel Wing





① New York





660-102 / ~ 70 x 195 x 13 cm / ~ 4 kg / ~ 32 W / LED / ☆ P-2, 25 cm    

② Trinity Star

660-211 / ~ 154 x 150 cm / ~ 7 kg / ~ 63 W / LED  / ☆ P-2, 80 cm 

③ Paris

660-104 / ~ 140 x 140 x 45 cm / ~ 7 kg / ~ 23 W / LED / ☆ P-2, 25 cm    

660-105 / ~ 140 x 140 x 45 cm / ~ 7 kg / ~ 23 W / LED / ☆ P-2, 25 cm    

④ Angel Wing

660-204 / ~ 110 x 179 cm / ~ 7 kg / ~ 42 W / LED  / ☆ P-2, 80 cm 



A sketch of your lamp is required when ordering!

Pole



① Pegasus Mast



② Cassiopeia Mast



③ Polaris Pole



④ Ice Dance



- ① Pegasus Mast 660-107 / ~ 125 x 290 cm / ~ 13 kg / ~ 112 W / / P-3, 90 cm
- 660-108 / ~ 125 x 290 cm / ~ 13 kg / ~ 112 W / / P-3, 90 cm
- ② Cassiopeia Mast 660-109 / ~ 145 x 260 cm / ~ 9 kg / ~ 74 W / / P-2, 120 cm
- ③ Polaris Pole 660-110 / ~ 98 x 200 cm / ~ 9 kg / ~ 63 W / / P-2, 120 cm
- 660-210 / ~ 98 x 200 cm / ~ 9 kg / ~ 63 W / / P-2, 120 cm
- ④ Ice Dance 660-208 / ~ 95 x 183 cm / ~ 5.2 kg / ~ 53 W / / P-2, 60 cm



① Geometric Pole



② Prague



③ Noel America

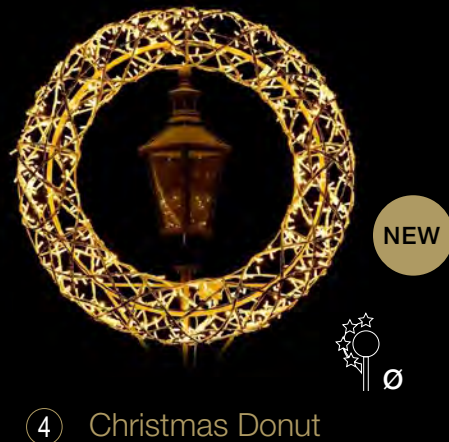

④ Christmas Donut

- ① Geometric Pole 660-207 / ~ 140 x 300 cm / ~ 9.5 kg / ~ 42 W / LED / P-2, 60 cm
- ② Prague 660-113 / ~ 60 x 220 x 45 cm / ~ 5 kg / ~ 39 W / LED / P-2, 60 cm
- ③ Noel America 660-114 / ~ 116 x 156 x 30 cm / ~ 8 kg / ~ 35 W / LED / P-2, 40 cm
- ④ Christmas Donut 660-205 / ~ 150 x 196 x 30 cm / ~ 14.5 kg / ~ 46 W / LED / P-2, 60 cm



A sketch of your lamp is required when ordering!

Pole









① Celebration Bow



② Christmas Swing Pole



③ Celebration Wave

- ① Celebration Bow 660-116 / ~ 93 x 215 x 55 cm / ~ 8 kg / ~ 39 W / LED LED ■ ■ / ☆ P-2, 140 cm 3D  
- ② Christmas Swing Pole 660-206 / ~ 100 x 280 x 60 cm / ~ 16 kg / ~ 49 W / LED LED ■ ■ / ☆ P-3, 120 cm 3D  
- ③ Celebration Wave 660-118 / ~ 70 x 174 x 25 cm / ~ 5 kg / ~ 18 W / LED ■ ■ / ☆ P-2, 160 cm 3D  



A sketch of your lamp is required when ordering!

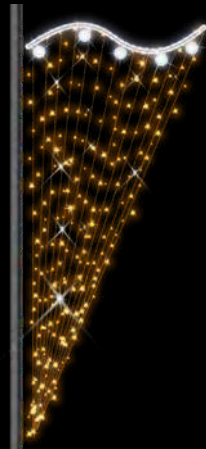

① Drape Wave



② Pentor Crown

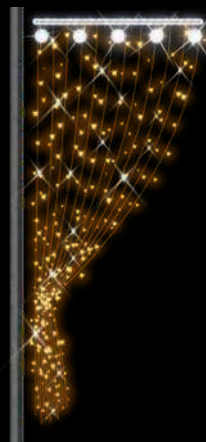

③ Drape Swing

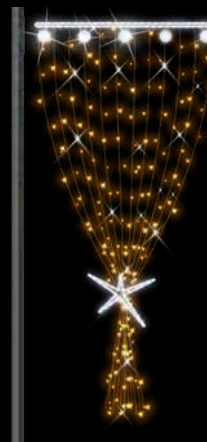

④ Drape Astero

- | | |
|----------------|---|
| ① Drape Wave | 660-120 / ~ 90 x 210 cm / ~ 6 kg / ~ 35 W / LED LED / x 5 / ☆ P-2, 120 cm |
| | 660-121 / ~ 90 x 210 cm / ~ 6 kg / ~ 35 W / LED LED / x 5 / ☆ P-2, 120 cm |
| ② Pentor Crown | 660-122 / ~ 122 x 185 x 122 cm / ~ 25.5 kg / ~ 140 W / LED LED / ☆ P-4 3D |
| ③ Drape Swing | 660-123 / ~ 95 x 190 cm / ~ 6 kg / ~ 28 W / LED LED / x 5 / ☆ P-2, 120 cm |
| | 660-124 / ~ 95 x 190 cm / ~ 6 kg / ~ 28 W / LED / x 5 / ☆ P-2, 120 cm |
| ④ Drape Astero | 660-125 / ~ 95 x 195 cm / ~ 7 kg / ~ 35 W / LED LED / x 5 / ☆ P-2, 120 cm |
| | 660-126 / ~ 95 x 195 cm / ~ 7 kg / ~ 35 W / LED / x 5 / ☆ P-2, 120 cm |

Stars & Flakes



① Astero Pole



② Astero Space



③ Comet



④ Comet Wega

① Astero Pole	660-127 / ~ 135 x 225 cm / ~ 10 kg / ~ 81 W / / P-2, 120 cm
	660-128 / ~ 135 x 225 cm / ~ 10 kg / ~ 81 W / / P-2, 120 cm
② Astero Space	660-129 / ~ 185 x 155 cm / ~ 6 kg / ~ 49 W / / T-3
	660-130 / ~ 185 x 155 cm / ~ 6 kg / ~ 49 W / / T-3
③ Comet	660-131 / ~ 140 x 105 cm / ~ 4 kg / ~ 35 W / / P-2, 80 cm
③ Comet Wega	660-132 / ~ 110 x 115 cm / ~ 4 kg / ~ 25 W / / P-2, 100 cm



Standard



Variations

Bulbs

Bulbs &
String Lite™

String Lite™

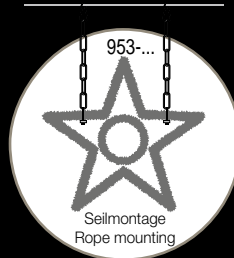
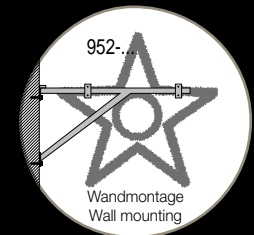
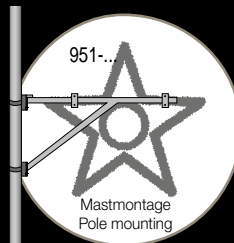

Bulbs see on page 68-73

Classic



- ① 951-013 / ~ 140 x 250 cm / ~ 11.5 kg /  / x 29 / 
952-013 / ~ 140 x 250 cm / ~ 11.5 kg /  / x 29 / 
954-013 / ~ 140 x 250 cm / ~ 11.5 kg /  / x 29 / 

Classic
across street

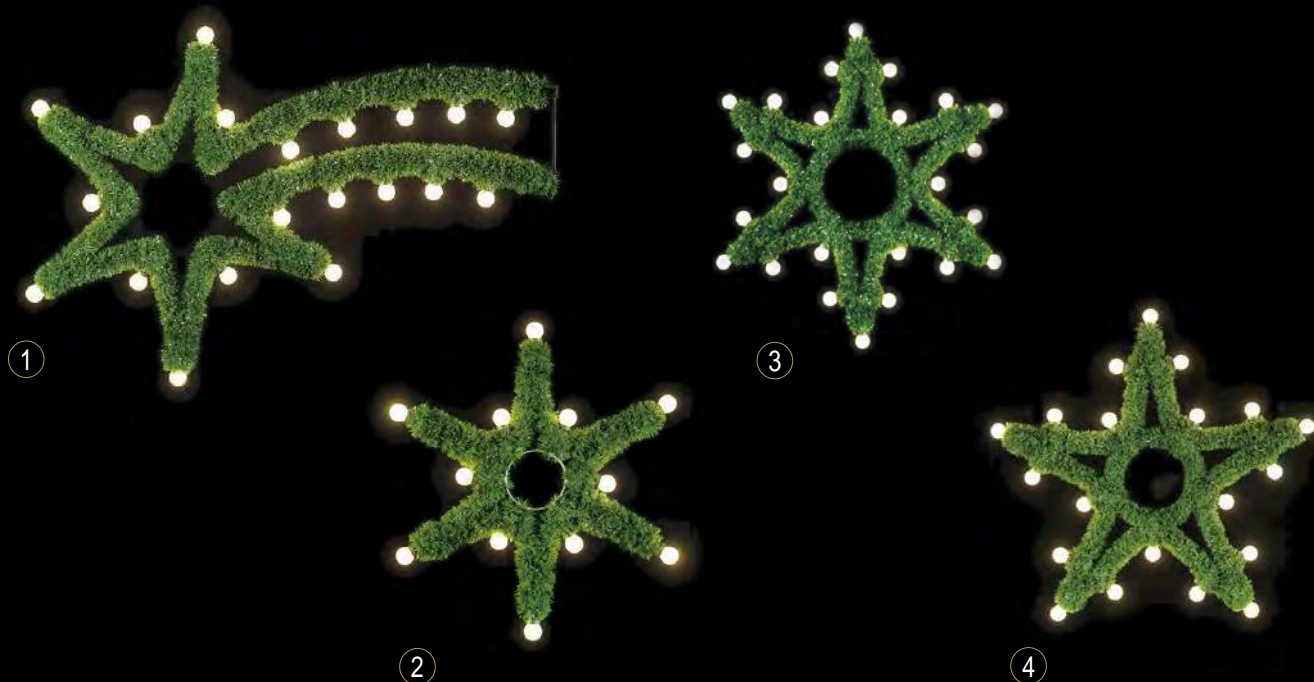

- ① 951-021 / ~ 130 x 80 cm / ~ 3.2 kg / ☑ / x 20 / ☆
 952-021 / ~ 130 x 80 cm / ~ 3.2 kg / ☑ / x 20 / ☆
 953-021 / ~ 130 x 80 cm / ~ 3.2 kg / ☑ / x 20 / ☆
 954-021 / ~ 130 x 80 cm / ~ 3.2 kg / ☑ / x 20 / ☆
- ② 951-001 / ~ 65 x 70 cm / ~ 2 kg / ☑ / x 12 / ☆
 952-001 / ~ 65 x 70 cm / ~ 2 kg / ☑ / x 12 / ☆
 953-001 / ~ 65 x 70 cm / ~ 2 kg / ☑ / x 12 / ☆
 954-001 / ~ 65 x 70 cm / ~ 2 kg / ☑ / x 12 / ☆
- ③ 951-003 / ~ 85 x 95 cm / ~ 2.9 kg / ☑ / x 24 / ☆
 952-003 / ~ 85 x 95 cm / ~ 2.9 kg / ☑ / x 24 / ☆
 953-003 / ~ 85 x 95 cm / ~ 2.9 kg / ☑ / x 24 / ☆
 954-003 / ~ 85 x 95 cm / ~ 2.9 kg / ☑ / x 24 / ☆



⑤

-
- ④ 951-002 / ~ 90 x 90 cm / ~ 2.8 kg /  / x 20 / ☆
 - 952-002 / ~ 90 x 90 cm / ~ 2.8 kg /  / x 20 / ☆
 - 953-002 / ~ 90 x 90 cm / ~ 2.8 kg /  / x 20 / ☆
 - 954-002 / ~ 90 x 90 cm / ~ 2.8 kg /  / x 20 / ☆
 - ⑤ 953-008 / ~ 860 x 160 cm / ~ 21 kg /  / x 112 / ☆
 - 954-008 / ~ 860 x 160 cm / ~ 21 kg /  / x 112 / ☆

Bulbs see on page 68-73

LIGHT COMPOSITIONS

Classic pole & lamp



①



②



③

- ① 951-007 / ~ 130 x 260 cm / ~ 10.5 kg / / x 34 / ☆
952-007 / ~ 130 x 260 cm / ~ 10.5 kg / / x 34 / ☆
954-007 / ~ 130 x 260 cm / ~ 10.5 kg / / x 34 / ☆
- ② 951-014 / ~ 100 x 150 cm / ~ 4.8 kg / / x 16 / ☆
952-014 / ~ 100 x 150 cm / ~ 4.8 kg / / x 16 / ☆
954-014 / ~ 100 x 150 cm / ~ 4.8 kg / / x 16 / ☆
- ③ 951-015 / ~ 90 x 85 cm / ~ 3.5 kg / / x 20 / ☆
952-015 / ~ 90 x 85 cm / ~ 3.5 kg / / x 20 / ☆
954-015 / ~ 90 x 85 cm / ~ 3.5 kg / / x 20 / ☆

Bulbs see on page 68-73

more Classic Motifs on request



Brixen - Italy





Meppen - Germany



Meppen - Germany

QuickFix™ 3+ Accessories

QuickFix™ Main Connector

	EU	UK	CH	AU 
	003-001	003-003	003-005	003-007
	003-002	003-004	003-006	003-008

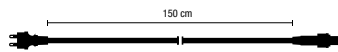

Anschluss: Zuleitung an QuickFix™
max. Belastbarkeit: 1800 W (820C)



QuickFix™ Adapter



Adapter: LED Gummiprodukte an QuickFix™
max. Belastbarkeit: 1800 W (820C)



QuickFix™ Divider 2

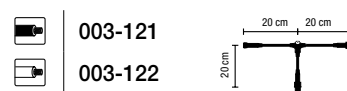

T-Verbinder, Verteilerkabel mit 2 Ausgängen
max. Belastbarkeit: 1800 W (820C)



NEW!

QuickFix™ Divider 3

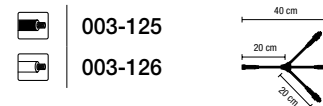

Verteilerkabel mit 3 Ausgängen
max. Belastbarkeit: 1800 W (820C)



QuickFix™ Extension 1

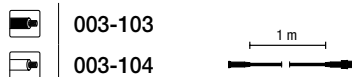

Verlängerungskabel 1 m
max. Belastbarkeit: 1800 W (820C)



QuickFix™ Extension 3



Verlängerungskabel 3 m
max. Belastbarkeit: 1800 W (820C)



QuickFix™ Extension 10

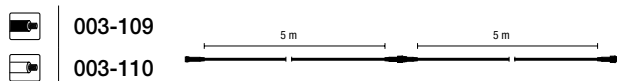

Verlängerungskabel 10 m
teilbar in 2 Segmente á 5m
max. Belastbarkeit: 1800 W (820C)



QuickFix™ Extension 20



Verlängerungskabel 20 m
max. Belastbarkeit: 1800 W (820C)



QuickFix™ 3+ pole/bracket supply cable

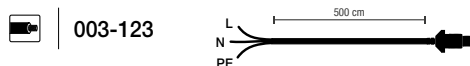

Länge: 5 m
Abhängig von der Mastgröße
für Halter (941-039) oder Direktmontage



QuickFix™ 3+ pole/bracket supply cable

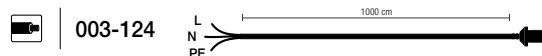

Länge: 10 m
Abhängig von der Mastgröße
für Halter (941-039) oder Direktmontage

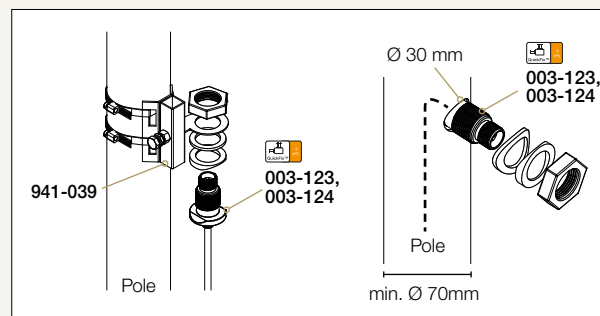

Light Compositions *Accessories*



Hängemontage – Fest verbundener Rahmen

T Hängemontage

2 Befestigungspunkte: 2

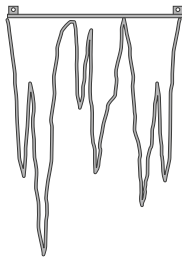

T Hängemontage

3 Befestigungspunkte: 3



Steckmontage – Fest verbundener Rahmen

P Steckmontage auf Wand oder Laternen

2 Befestigungspunkte: 2

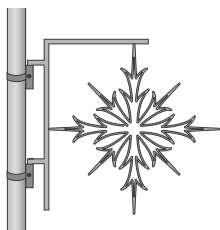

P Steckmontage auf Wand oder Laternen

3 Befestigungspunkte: 3



P Steckmontage auf Wand oder Laternen

4 Befestigungspunkte: 4

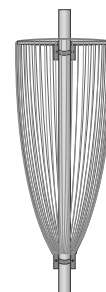

P Mastmontage

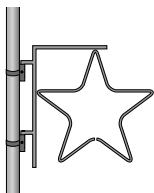

941-006
Halbschelle



941-002
Ø 80 - 100 mm
Schlauchklemme DIN 3017-AS W4



941-738
Halbschelle mit Steckdose



941-003
Ø 100 - 120 mm
Schlauchklemme DIN 3017-AS W4



941-039
Halbschelle für QuickFix™ 3+
(passend für 003-123, 003-124)



P Wandmontage

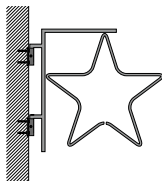

941-004
Fassadenschelle



941-005
Fassadenschelle mit Steckdose

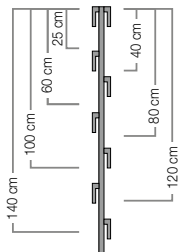

941-035
Montagelehre für Mastschelle

~151 x 10 cm



MK ILLUMINATION
PRODUCTS

LIGHT SCULPTURES



Topwin Center, Beijing Sanlitun – China



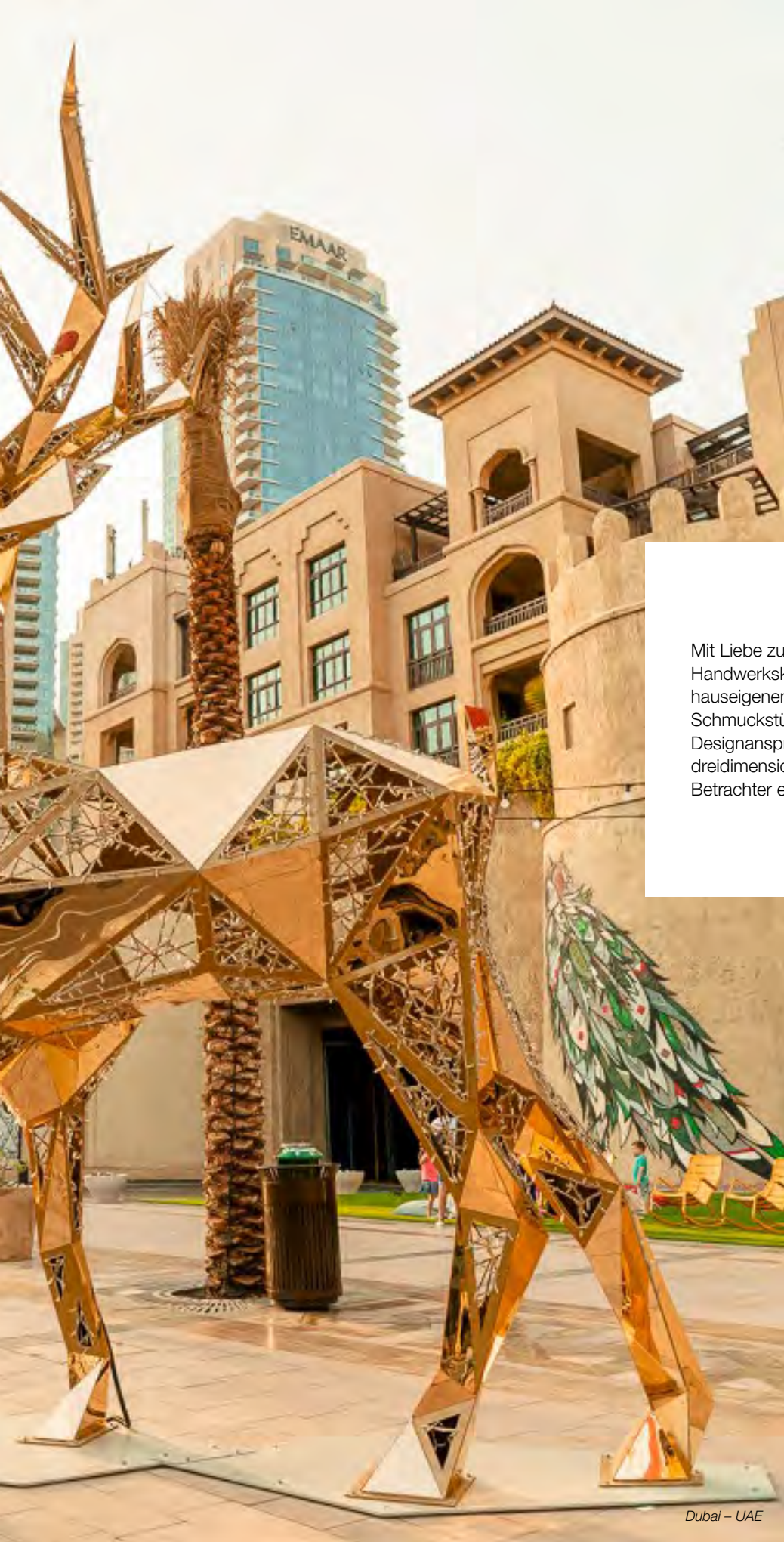

Mit Liebe zum Detail und in feinsten Handwerkskunst entstehen in unserer hauseigenen Manufaktur wahre Schmuckstücke von höchstem Designanspruch. Leuchtende dreidimensionale Unikate, die ihrem Betrachter echte Glücksmomente bereiten.



The Solow Building, New York – USA



Saks Fifth Avenue, New York – USA



Kolding Storcenter – Denmark



Glostrup Storcenter – Denmark



Capitol Shopping Center, Istanbul – Turkey



Ruihong Tiandi, Shanghai – China







Haldenzauber Hückelhoven – Germany



Gallerian, Stockholm – Schweden



Livit, Zürich – Schweiz



Stuttgart – Germany



Koper – Slovenia





Antara Fashion Hall, Mexico City – Mexico



Espark Shopping Mall, Eskişehir – Turkey



Essen – Germany



Old Montreal – Canada



Stuttgart – Germany



Deventer – Netherlands



PRODUCT OVERVIEW



String Lite[®]

	120 LED 20 m						120 LED 12 m						160 LED 8 m					
	019- ...		029- ...		017- ...		019- ...		029- ...		017- ...		019- ...		029- ...		017- ...	
Color	310	309	019	169	043	044	312	311	088	002	167	041	042	368	408	080		074
Flash	323	324	024			045	358	357		001	089		076	369	409		079	075
LED							366	367										
LED							327	328		048	115					081		
LED							325	326		049	098				403	082		
LED	359	360								071					410	076		
LED	361	363								072					411	077		
LED	362									074						084		
LED	364																	
LED	427	365								073					412	078		
LED										116								
LED										117								
QFC	3.5	5	3.5				5	5	5				7	6.5	7			
QFU	20	50	20				12	30	12				8	20	8			
Watt	7 W	4.3 W	7 W				10.5 W	4.3 W	10.5 W				14 W	5.8 W	14 W			
Page																		

PRODUCT OVERVIEW



Drape Lite®

	240 LED	600 LED	140 LED	200 LED	200 LED	200 LED	300 LED	400 LED	600 LEDs	600 LED	800 LED	1200 LED											
	2 m	5 m	2 m	2 m	2 m	2 m	2 m	2 m	2 m	2 m	2 m	2 m											
	0.4 m	0.4 m	1 m	0.4 m	1 m	1.5 m	1.5 m	3 m	3 m	4.5 m	6 m	6 m											
Color	Flash	017- ...	029- ...	019- ...	019- ...	029- ...	019- ...	017- ...	029- ...	019- ...	017- ...	029- ...	019- ...	017- ...									
		069	067	128	062	061	066	065	004	330	329	046	067	332	331	047	139	069	334	333	040		
		070	068	129	064	063	068	067	003	430	335	055	068	432	336	056	140	070	441	337	057		
									112	431	339			433	341								
									052	423	338	058		434	340	059						060	
QFC	7	18	6	3.5	3.5	8	18	18	16	18	18	24	32	36	36								
QFU	8	16	32.5	43	43	32.5	16	16	50	16	16	75	100	32	32								
Watt	14 W	35 W	5 W	7 W	7 W	7.2 W	35 W	35 W	14.4 W	35 W	35 W	21.6 W	28.8 W	70 W	70 W								
Page	49	49	49	23	23	51	51	53	53	53	53	57	57	57	57								

PRODUCT OVERVIEW



Ice Lite®

		80 LED	114 LED	120 LED	174 LED	240 LED	304 LED
		2 m	3 m	2 m	3 m	4 m	4 m
		0.5 m	0.5 m	0.9 m	0.9 m	1.5 m	1.5 m
Color	Flash	029- ...	019- ...	029- ...	019- ...	029- ...	019- ...
		118	343	010	345	058	347
		119	348	009	349	059	346
			398		400		396
			352	113	351	114	
			353	056	350	060	
			390				397
QFC							
QFU							
Watt		3 W	7 W	4.3 W	10.5 W	8.6 W	14 W
Page							

REGISTER

Code NEW Nr. NEU	Code OLD Nr. ALT	Page Seite							
8159750590		145	150-090	192	150-614	193	001-131	014-011	127
8159770590		145	150-091	192	150-615	193	001-132	014-249	127
8208750090		145	150-093	192	150-617	193	001-138		41
8208830090		145	150-095	192	150-620	193	001-141	244-033	129
8600830000		144	150-097	192	150-621	193	001-142	244-034	129
8601230000		144	150-098	192	150-627	193	001-143	244-244	129
8601630000		144	150-103	192	150-629	193	001-144	244-230	129
8610820400		144	150-120	193	150-630	193	001-145	244-231	129
8611620400		144	150-121	193	150-633	193	001-146	244-245	129
8700830000		144	150-124	193	150-636	193	001-153	244-036	79
8701230000		144	150-127	193	150-637	193	001-154	244-254	79
8701630000		144	150-128	193	150-782	193	001-701		129
8702330000		144	150-132	193	150-783	193	001-702		129
8710835590		144	150-136	193	150-784	193	001-704	015-030	129
8710835690		144	150-137	193	150-786	193	001-795		129
8710835790		144	150-184	193	150-788	193	001-796		129
8710835890		144	150-185	193	150-789	193	001-799		129
8710835990		144	150-187	193	150-791	193	002-008	014-143	135
8710835992		144	150-188	193	150-792	193	002-009	014-144	135
8720830000		144	150-192	193	150-797	193	002-010	014-145	135
8721630000		144	150-193	193	150-798	193	002-011	014-146	135
9631530000		142	150-195	193	001-001	014-233	002-012	014-031	135
9631535800		142	150-197	193	001-002	014-234	002-013	014-151	135
9633030000		142	150-198	193	001-003	015-066	002-014	014-147	136
9681044000		140	150-553	192	001-004	015-068	002-015	014-162	136
9691005000		142	150-554	192	001-005	015-067	002-016	014-163	136
9691505000		142	150-555	192	001-006	015-069	002-018		135
9691505010		142	150-558	192	001-007	015-362	002-101		137
9691505600		142	150-559	192	001-008	015-363	002-102		137
9692005000		142	150-560	192	001-011	014-418	002-103	015-082	137
9692005600		142	150-561	192	001-012	014-419	002-104	015-012	137
9693005000		142	150-562	192	001-013	015-070	002-105	015-876	137
9693005500		142	150-563	192	001-014	015-072	002-106	015-197	137
9693005600		142	150-565	192	001-015	015-071	002-109	015-083	137
9751503000		143	150-567	192	001-016	015-073	002-110	015-013	137
9751505500		143	150-568	192	001-017	015-364	002-121	015-084	137
9751505600		143	150-569	192	001-018	015-365	002-122	015-010	137
9753003000		143	150-570	192	001-021	444-001	002-125	015-085	137
9753005500		143	150-571	192	001-023	444-002	002-126	015-011	137
9753005600		143	150-572	192	001-025	444-003	002-129	014-125	137
9771530000		143	150-578	192	001-031	014-244	002-130	015-014	137
9771530011		141	150-579	192	001-032	014-246	002-142	244-248	137
9771531000		143	150-581	192	001-033	014-919	002-143	244-247	137
9771535900		143	150-582	192	001-034	014-920	002-145	244-249	137
9771535901		143	150-584	192	001-101		002-146	244-246	137
9771535910		143	150-587	192	001-102		002-149		87
9771535911		143	150-588	192	001-103	014-309	002-150		87
9773030000		143	150-589	192	001-104	014-310	002-795		137
9773035900		143	150-590	192	001-105	014-013	002-796		137
9773035901		143	150-591	192	001-106	014-014	002-799		137
9773035910		143	150-592	192	001-109	014-008	003-001	014-126	134
9773035911		143	150-593	192	001-110	014-009	003-002	014-130	134
150-055		192	150-597	192	001-111	014-149	003-003	014-127	134
150-071		192	150-598	192	001-121	014-017	003-004	014-131	134
150-072		192	150-602	192	001-122	014-253	003-005	014-128	134
150-074		192	150-604	193	001-125	014-316	003-006	014-132	134
150-080		192	150-605	193	001-126	014-443	003-007	014-129	134
150-084		192	150-607	193	001-127	014-307	003-008	014-133	134
150-085		192	150-608	193	001-128	014-308	003-103	014-136	134
150-088		192	150-609	193	001-129	014-010	003-104	014-137	134
150-089		192	150-613	193	001-130	014-248	003-105	014-138	134

REGISTER

Code NEW **Code OLD** **Page**
 Nr. NEU Nr. ALT Seite

003-106	014-139	134	011-155	113	017-060	017-060	57	019-348	018-348	59	
003-109	014-140	134	011-156	113	017-065	017-065	47	019-349	018-349	61	
003-110	014-141	134	013-125	69	017-066	017-066	47	019-350	018-350	61	
003-111	014-142	134	013-126	69	017-067	017-067	49	019-351	018-351	61	
003-121	014-134	134	014-100	014-100	71	017-068	017-068	49	019-352	018-352	59
003-122	014-135	134	014-101	014-101	71	017-069	017-069	49	019-353	018-353	59
003-123	014-164	323	014-102	014-102	71	017-070	017-070	49	019-357	018-357	31
003-124	014-165	323	014-103	014-103	71	017-071	017-071	47	019-358	018-358	31
003-125	134	014-104	014-104	71	017-072	017-072	47	019-359	018-359	29
003-126	134	014-105	014-105	71	017-074	017-074	33	019-360	018-360	29
003-161	014-150	134	014-106	014-106	71	017-075	017-075	33	019-361	018-361	29
003-162	134	014-148	014-148	35	017-076	017-076	31	019-362	018-362	29
007-001	014-514	131	014-445	014-445	73	019-001	21	019-363	018-363	29
007-002	014-515	131	014-446	014-446	73	019-002	21	019-364	018-364	29
007-011	015-618	131	014-447	014-447	73	019-003	21	019-365	018-365	29
007-012	014-937	131	014-448	014-448	73	019-061	23	019-366	018-366	31
007-014	015-064	131	014-449	014-449	73	019-062	23	019-367	018-367	31
007-016	015-065	131	014-450	014-450	73	019-063	23	019-368	018-368	33
007-018	015-366	131	014-855	014-855	127	019-064	23	019-369	018-369	33
007-033	015-077	130	014-942	014-942	51	019-065	23	019-373	018-373	51
007-103	015-875	131	014-943	014-943	53	019-066	23	019-374	018-374	51
007-104	015-874	131	015-022	015-022	73	019-067	23	019-378	018-378	53
007-106	015-075	131	015-023	015-023	73	019-068	23	019-390	018-390	59
007-110	014-124	131	015-032	130	019-101	25	019-396	018-396	63
007-121	015-352	131	015-063	015-063	57	019-102	25	019-397	018-397	63
007-122	015-351	131	015-078	015-078	69	019-237	018-237	27	019-398	018-398	59
007-126	015-074	130	015-079	015-079	69	019-238	018-238	27	019-400	018-400	61
007-130	014-938	130	015-080	015-080	69	019-274	018-274	117	019-404	018-404	45
007-165	014-452	131	015-081	015-081	69	019-278	018-278	117	019-405	018-405	45
007-166	015-076	131	015-142	015-142	171	019-309	018-309	29	019-406	018-406	43
008-000	205	015-143	015-143	171	019-310	018-310	29	019-407	018-407	43
008-001	205	015-146	015-146	171	019-311	018-311	31	019-408	018-408	33
008-003	205	015-218	69	019-312	018-312	31	019-409	018-409	33
008-004	206	015-219	69	019-313	018-313	35	019-410	018-410	33
008-007	206	015-315	015-315	51	019-314	41	019-411	018-411	33
008-010	205	015-316	015-316	53	019-316	141	019-412	018-412	33
008-011	206	015-317	015-317	57	019-323	018-323	29	019-419	018-419	43
008-013	207	015-318	015-318	51	019-324	018-324	29	019-420	018-420	43
008-014	207	015-319	015-319	53	019-325	018-325	31	019-423	018-423	51
008-200	227	015-320	015-320	57	019-326	018-326	31	019-427	018-427	29
008-500	89	015-357	015-357	73	019-327	018-327	31	019-428	018-428	45
010-101	87	015-359	015-359	73	019-328	018-328	31	019-429	018-429	45
010-102	87	015-361	015-361	130	019-329	018-329	51	019-430	018-430	51
010-103	87	015-367	015-367	127	019-330	018-330	51	019-431	018-431	51
010-104	87	015-388	015-388	35	019-331	018-331	53	019-432	018-432	53
010-105	87	015-389	015-389	35	019-332	018-332	53	019-433	018-433	53
010-106	87	015-691	015-691	71	019-333	018-333	57	019-434	018-434	53
010-107	87	015-722	015-722	71	019-334	018-334	57	019-435	018-435	59
010-108	87	017-040	017-040	57	019-335	018-335	51	019-436	018-436	59
010-109	87	017-041	017-041	31	019-336	018-336	53	019-437	018-437	59
010-110	87	017-042	017-042	31	019-337	018-337	57	019-438	018-438	61
010-111	87	017-043	017-043	29	019-338	018-338	51	019-439	018-439	61
010-112	87	017-044	017-044	29	019-339	018-339	51	019-440	018-440	61
011-144	113	017-045	017-045	29	019-340	018-340	53	019-441	57
011-145	113	017-046	017-046	51	019-341	53	019-900	014-077	51
011-146	113	017-047	017-047	53	019-342	018-342	59	019-901	014-099	51
011-147	113	017-055	017-055	51	019-343	018-343	59	019-902	014-108	51
011-148	113	017-056	017-056	53	019-344	018-344	61	019-903	014-412	51
011-149	113	017-057	017-057	57	019-345	018-345	61	019-904	014-413	51
011-152	113	017-058	017-058	51	019-346	018-346	63	019-905	014-467	51
011-153	113	017-059	017-059	53	019-347	018-347	63	019-906	014-833	51

REGISTER

Code NEW **Code OLD** **Page**
 Nr. NEU Nr. ALT Seite

019-907	014-834	51	029-094	028-094	37	029-662	107	150-047	941-162	187	
019-908	014-927	51	029-095	028-095	37	029-663	107	150-048		187	
019-909	014-928	51	029-096	028-096	37	029-664	107	150-049	941-164	187	
019-910	014-109	53	029-097	028-097	37	029-665	107	150-050	941-158	186	
019-911	014-121	53	029-098	028-098	31	029-680	111	150-051	941-160	186	
019-912	014-122	53	029-109	028-109	43	029-681	111	150-052	941-161	186	
019-913	014-414	53	029-111	028-111	43	029-682	111	150-053	938-010	192	
019-914	014-415	53	029-112	028-112	51	035-242	209	150-054	939-480	192	
019-915	014-468	53	029-113	028-113	61	035-243	209	150-056	938-008	192	
019-916	014-835	53	029-114	028-114	63	035-244	209	150-057	939-495	192	
019-917	014-929	53	029-115	028-115	31	035-245	209	150-058	939-490	192	
019-918		53	029-116	028-116	31	035-246	209	150-059	938-007	192	
019-919	014-469	57	029-117	028-117	31	035-327	171	150-060	939-517	192	
019-920	014-470	57	029-118	028-118	59	041-035	227	150-061	939-523	192	
019-921	014-836	57	029-119	028-119	59	112-022	112-022	39	150-062	939-500	192
019-922		57	029-128	028-128	49	112-113	112-113	39	150-063	938-512	192
029-001	028-001	31	029-129	028-129	49	112-116	112-116	39	150-064	939-455	192
029-002	028-002	31	029-139	028-139	55	112-117	112-117	39	150-065	939-465	192
029-003	028-003	51	029-140	028-140	55	112-118	112-118	39	150-066	939-470	192
029-004	028-004	51	029-149		65	112-119	112-119	39	150-067	939-475	192
029-009	028-009	61	029-150		65	112-120	112-120	39	150-068	939-460	192
029-010	028-010	61	029-151		65	112-121	112-121	39	150-069	938-009	192
029-011	028-011	65	029-152		65	122-025		39	150-070	938-005	192
029-012	028-012	65	029-155		199	150-001	931-439	177	150-073	938-003	192
029-013	028-013	65	029-156		115	150-002	931-420	177	150-075	939-491	192
029-014	028-014	65	029-157		201	150-003		177	150-076	938-002	192
029-019	028-019	29	029-158		121	150-004		177	150-077	939-518	192
029-024	028-024	29	029-160		121	150-005	931-435	175	150-078	939-524	192
029-048	028-048	31	029-163		203	150-006	931-437	175	150-079	939-501	192
029-049	028-049	31	029-164		203	150-007	931-423	175	150-081	939-456	192
029-052	028-052	51	029-165		203	150-008	931-425	175	150-082	939-466	192
029-056	028-056	61	029-166		203	150-012	943-697	184	150-083	939-471	192
029-058	028-058	63	029-167		31	150-013	939-711	184	150-086	938-004	192
029-059	028-059	63	029-169		29	150-014	939-704	185	150-087	931-898	192
029-060	028-060	63	029-173		119	150-015	939-705	185	150-092	939-492	192
029-064	028-064	67	029-174		119	150-016	939-706	185	150-094	939-519	192
029-065	028-065	67	029-175		119	150-021	931-427	181	150-096	939-502	192
029-067	028-067	53	029-177		119	150-022	931-429	181	150-099	939-467	192
029-068	028-068	53	029-178		119	150-023		181	150-100	939-472	192
029-069	028-069	57	029-179		119	150-024		181	150-101	939-477	192
029-070	028-070	57	029-180		119	150-025	939-534	183	150-102	939-462	192
029-071	028-071	31	029-182		119	150-026	939-707	183	150-104	931-384	193
029-072	028-072	31	029-183		121	150-027	941-167	182	150-105	939-483	193
029-073	028-073	31	029-187		121	150-028	941-166	182	150-106	939-488	193
029-074	028-074	31	029-188		121	150-029	941-165	182	150-107	931-380	193
029-076	028-076	33	029-192		121	150-030	941-174	182	150-108	939-498	193
029-077	028-077	33	029-193		121	150-031	941-170	182	150-109	939-493	193
029-078	028-078	33	029-194		121	150-032	941-169	182	150-110	931-378	193
029-079	028-079	33	029-195		119	150-033	941-168	182	150-111	939-520	193
029-080	028-080	33	029-196		119	150-034	941-175	182	150-112	939-526	193
029-081	028-081	33	029-197		119	150-035	941-186	179	150-113	939-503	193
029-082	028-082	33	029-198		119	150-036	941-187	179	150-114	939-515	193
029-084	028-084	33	029-210		119	150-037	941-188	179	150-115	939-458	193
029-086	028-086	27	029-211		119	150-038	941-189	179	150-116	939-468	193
029-087	028-087	27	029-212		119	150-039	941-182	178	150-117	939-473	193
029-088	028-088	31	029-213		119	150-040	941-181	178	150-118	939-478	193
029-089	028-089	31	029-214		200	150-041	941-180	178	150-119	939-463	193
029-090	028-090	37	029-215		200	150-042	941-151	178	150-122	939-484	193
029-091	028-091	37	029-313		35	150-043	941-185	178	150-123	939-489	193
029-092	028-092	37	029-660		107	150-044	941-184	178	150-125	939-499	193
029-093	028-093	37	029-661		107	150-045	941-183	178	150-126	939-494	193
						150-046	941-152	178	150-129	939-527	193

REGISTER

Code NEW **Code OLD** **Page**
 Nr. NEU Nr. ALT Seite

150-130	939-504	193	150-533	941-097	182	150-709	195	160-026	933-828	215
150-131	939-516	193	150-534	941-104	182	150-742	186	160-027	933-829	215
150-133	939-469	193	150-535	941-116	179	150-743	186	160-028	933-832	216
150-134	939-474	193	150-536	941-117	179	150-744	186	160-029	933-499	216
150-135	939-479	193	150-537	941-118	179	150-745	186	160-030	933-415	216
150-138	197	150-538	941-119	179	150-746	186	160-031	933-500	217
150-139	197	150-539	941-111	178	150-747	186	160-032	032-210	217
150-140	197	150-540	941-110	178	150-748	184	160-033	032-235	217
150-141	197	150-541	941-109	178	150-749	184	160-034	032-226	218
150-142	186	150-542	941-080	178	150-750	184	160-035	032-208	218
150-143	186	150-543	941-115	178	150-751	184	160-036	933-689	218
150-144	186	150-544	941-113	178	150-752	181	160-037	933-830	218
150-145	186	150-545	941-112	178	150-753	181	160-038	032-236	218
150-146	186	150-546	941-081	178	150-754	177	160-039	032-024	218
150-147	186	150-547	941-091	187	150-755	177	160-040	933-704	218
150-148	184	150-548	941-092	187	150-756	177	160-041	933-705	218
150-149	184	150-549	941-093	187	150-757	177	160-042	032-232	219
150-150	184	150-550	941-087	186	150-758	185	160-043	032-017	219
150-151	184	150-551	941-089	186	150-759	175	160-044	933-724	219
150-152	181	150-552	941-090	186	150-760	175	160-045	933-264	219
150-153	181	150-556	939-570	192	150-775	195	160-046	933-809	219
150-154	177	150-557	939-566	192	150-776	195	160-047	032-228	219
150-155	177	150-564	939-555	192	150-777	195	160-048	032-209	219
150-156	177	150-566	939-564	192	150-778	195	160-049	933-815	220
150-157	177	150-573	939-588	192	150-779	195	160-050	933-813	220
150-158	185	150-574	939-583	192	150-785	193	160-051	933-810	220
150-159	175	150-575	939-577	192	150-787	193	160-052	933-698	221
150-160	175	150-576	939-589	192	150-790	193	160-053	933-804	221
150-182	193	150-577	939-582	192	150-793	193	160-054	933-699	221
150-183	193	150-580	939-574	192	150-794	193	160-055	032-218	223
150-186	193	150-583	939-581	192	150-795	193	160-056	032-217	223
150-189	193	150-585	939-585	192	150-796	193	160-057	941-378	223
150-190	193	150-586	939-590	192	150-800	195	160-058	941-379	223
150-191	193	150-594	939-601	192	150-801	195	160-059	933-668	223
150-194	193	150-595	939-598	192	150-802	195	160-060	933-662	223
150-196	193	150-596	939-594	192	150-803	195	160-062	214
150-501	939-652	177	150-599	939-597	192	150-804	195	160-063	214
150-502	939-651	177	150-600	939-600	192	150-805	195	160-064	214
150-503	177	150-601	939-603	192	150-806	195	160-065	214
150-504	177	150-603	939-608	192	150-807	195	160-066	213
150-505	939-645	175	150-606	939-617	193	150-808	195	160-067	213
150-506	939-646	175	150-610	939-624	193	150-809	195	160-070	213
150-507	939-653	175	150-611	939-619	193	160-001	210	160-074	213
150-508	939-654	175	150-612	939-616	193	160-002	210	160-076	213
150-512	184	150-616	939-615	193	160-003	210	160-077	216
150-513	939-710	184	150-618	939-625	193	160-004	210	160-078	219
150-514	939-696	185	150-619	939-610	193	160-005	210	160-079	219
150-515	939-697	185	150-622	939-631	193	160-006	210	160-501	939-877	222
150-516	939-698	185	150-623	939-635	193	160-013	941-248	160-502	939-879	222
150-521	939-647	181	150-624	939-642	193	160-014	941-247	160-503	939-881	222
150-522	939-648	181	150-625	939-638	193	160-015	941-249	160-504	939-878	222
150-523	181	150-626	939-632	193	160-016	941-252	160-505	939-880	222
150-524	181	150-628	939-637	193	160-017	941-251	160-506	939-882	222
150-525	939-677	183	150-631	939-629	193	160-018	032-224	160-507	222
150-526	939-708	183	150-632	939-627	193	160-019	032-025	160-508	222
150-527	941-096	182	150-634	939-636	193	160-020	933-683	160-509	222
150-528	941-095	182	150-635	939-639	193	160-021	933-684	160-510	222
150-529	941-094	182	150-705	195	160-022	933-826	160-511	222
150-530	941-103	182	150-706	195	160-023	933-685	160-512	222
150-531	941-099	182	150-707	195	160-024	933-827	160-513	208
150-532	941-098	182	150-708	195	160-025	933-808	160-514	208

REGISTER

Code NEW **Code OLD** **Page**
 Nr. NEU Nr. ALT Seite

160-515	208	244-253	244-253	93	660-014	932-875	251	660-093	933-863	304
160-516	208	244-255	244-255	79	660-018	933-949	257	660-094	932-770	306
160-517	208	244-259	244-009	93	660-019	933-950	257	660-095	932-841	306
160-518	208	245-019	245-019	79	660-020	932-949	257	660-096	932-876	308
160-519	208	245-020	245-020	79	660-021	932-950	257	660-097	932-935	308
160-520	208	245-030	245-013	85	660-022	933-951	258	660-098	941-345	308
160-521	209	245-031	245-014	85	660-023	933-952	258	660-099	932-878	308
160-522	209	245-032	245-015	85	660-026	933-947	259	660-100	932-873	309
160-523	209	245-033	245-016	85	660-027	933-948	259	660-101	932-877	309
160-524	209	245-034	245-017	85	660-028	932-947	259	660-102	941-284	310
160-525	209	245-035	245-018	85	660-029	932-948	259	660-104	941-283	310
160-526	209	245-036	245-021	85	660-030	933-956	259	660-105	941-339	310
170-046	167	245-037	245-022	85	660-031	932-956	259	660-107	932-842	311
170-047	167	245-038	111	660-035	933-955	260	660-108	932-843	311
170-181	015-181	245-039	107	660-036	932-953	260	660-109	932-773	311
170-344	015-344	245-040	107	660-037	932-954	260	660-110	932-756	311
170-345	015-345	248-200	248-058	81	660-038	933-953	260	660-112	932-907	266
170-346	015-346	248-201	248-057	81	660-039	933-954	260	660-113	941-331	312
170-348	015-348	248-202	248-059	81	660-043	933-902	264	660-114	943-758	312
170-349	015-349	248-203	248-060	81	660-044	933-900	265	660-116	932-938	313
170-489	014-489	248-204	248-061	81	660-045	933-903	263	660-118	932-937	313
190-485	014-485	248-205	248-062	81	660-047	932-914	266	660-120	932-793	314
190-486	014-486	248-206	248-028	83	660-049	941-352	270	660-121	932-570	314
190-490	014-490	248-208	248-003	83	660-050	941-347	270	660-122	932-635	314
190-491	014-491	290-092	014-092	153	660-051	941-346	270	660-123	314
190-807	290-093	014-093	153	660-052	271	660-124	932-860	314
190-808	290-094	014-094	153	660-055	932-844	272	660-125	932-775	314
190-811	290-114	163	660-056	932-730	275	660-126	932-572	314
201-001	015-880	290-115	163	660-058	933-881	276	660-127	932-726	315
201-002	150-881	290-116	163	660-059	960-020	278	660-128	932-439	315
202-001	015-727	290-132	163	660-062	960-043	282	660-129	933-763	315
202-005	290-133	163	660-063	960-010	283	660-130	933-762	315
202-008	290-134	163	660-064	960-044	284	660-131	932-826	315
202-009	290-174	167	660-065	284	660-132	932-790	315
202-010	290-175	167	660-066	960-019	284	660-133	281
202-205	290-176	167	660-067	941-321	288	660-134	305
202-206	290-638	157	660-068	941-322	288	660-135	307
202-207	290-639	157	660-069	941-329	288	660-136	306
202-209	290-640	157	660-070	941-330	288	660-137	307
202-210	290-811	159	660-071	941-320	288	660-138	307
202-211	290-812	159	660-072	941-319	288	660-139	305
205-001	290-813	159	660-073	941-328	288	660-141	305
205-002	290-814	159	660-074	941-327	288	660-142	309
205-003	015-882	290-815	159	660-075	960-024	290	660-143	292
205-004	015-883	290-942	154	660-076	960-025	290	660-144	292
206-001	290-943	154	660-077	933-817	289	660-145	253
244-002	244-002	290-944	154	660-078	932-817	289	660-146	253
244-003	244-003	290-946	155	660-079	943-045	289	660-147	292
244-005	244-005	290-947	155	660-080	924-272	289	660-148	292
244-006	244-006	290-948	155	660-081	960-026	292	660-149	241
244-014	244-014	290-955	156	660-082	960-027	292	660-151	306
244-023	244-023	290-956	156	660-083	933-884	302	660-152	306
244-035	244-035	290-957	156	660-084	933-939	302	660-153	307
244-037	244-037	600-217	307	660-085	933-880	302	660-154	309
244-201	244-201	620-060	235	660-086	933-885	303	660-156	291
244-217	244-217	660-001	933-889	236	660-087	941-270	303	660-157	291
244-218	244-218	660-002	933-886	240	660-088	941-342	303	660-158	241
244-219	244-219	660-004	941-350	241	660-089	933-716	304	660-159	248
244-250	244-250	660-005	932-932	242	660-090	933-530	304	660-160	278
244-251	244-251	660-006	932-933	242	660-091	933-769	304	660-161	278
244-252	244-252	660-007	932-934	242	660-092	933-775	304	660-162	238

REGISTER

Code NEW **Code OLD** **Page**
 Nr. NEU Nr. ALT Seite

660-163	238	931-373	191	938-752	191	939-453	191
660-164	238	931-374	191	938-753	191	939-454	191
660-165	236	931-377	191	938-754	191	941-002	941-002 227
660-166	246	931-379	191	938-755	191	941-003	941-003 227
660-167	287	931-381	191	938-756	191	941-004	941-004 227
660-168	272	931-383	191	938-757	191	941-005	941-005 227
660-169	277	931-387	191	938-758	191	941-006	941-006 227
660-170	237	931-389	191	938-759	191	941-017	941-017 227
660-171	287	931-391	191	938-760	191	941-033	941-033 227
660-172	269	931-393	191	938-761	191	941-035 227
660-173	289	931-397	191	938-762	191	941-039	941-039 325
660-174	235	931-401	191	938-763	191	941-061	941-061 227
660-175	282	931-863	191	938-764	191	941-397 191
660-177	239	931-864	191	938-765	191	941-402 191
660-181	295	931-866	191	938-766	191	941-738	941-007 227
660-182	297	931-881	191	938-767	191	951-001	951-001 318
660-183	298	931-919	191	938-768	191	951-002	951-002 319
660-184	941-291 272	931-920	191	938-769	191	951-003	951-003 318
660-185	252	931-921	191	938-771	191	951-007	951-007 320
660-186	254	931-922	191	938-772	191	951-013	951-013 317
660-187	254	931-923	191	938-773	191	951-014	951-014 320
660-188	254	931-924	191	938-774	191	951-015	951-015 320
660-189	248	931-925	191	938-775	191	951-021	951-021 318
660-190	245	931-926	191	938-776	191	952-001	952-001 318
660-191	248	931-927	191	938-777	191	952-002	952-002 319
660-192	296	931-928	191	938-778	191	952-003	952-003 318
660-193	296	931-929	191	938-779	191	952-007	952-007 320
660-194	298	931-930	191	938-780	191	952-013	952-013 317
660-195	298	931-931	191	938-781	191	952-014	952-014 320
660-196	240	938-024	191	938-782	191	952-015	952-015 320
660-197	235	938-025	191	938-783	191	952-021	952-021 318
660-198	235	938-036	191	938-784	191	953-001	953-001 318
660-199	260	938-037	191	938-785	191	953-002	953-002 319
660-200	260	938-721	191	938-786	191	953-003	953-003 318
660-201	260	938-723	191	938-787	191	953-008	953-008 319
660-202	258	938-725	191	938-788	191	953-021	953-021 318
660-203	258	938-726	191	938-789	191	954-001	954-001 318
660-204	310	938-727	191	938-790	191	954-002	954-002 319
660-205	312	938-728	191	938-791	191	954-003	954-003 318
660-206	313	938-729	191	938-792	191	954-007	954-007 320
660-207	312	938-730	191	938-793	191	954-008	954-008 319
660-208	311	938-731	191	938-794	191	954-013	954-013 317
660-209	307	938-732	191	938-795	191	954-014	954-014 320
660-210	311	938-733	191	938-796	191	954-015	954-015 320
660-211	310	938-734	191	938-797	191	954-021	954-021 318
660-212	278	938-735	191	938-798	191		
660-213	266	938-736	191	938-799	191		
660-214	264	938-737	191	938-800	191		
660-215	271	938-738	191	939-001	191		
660-216	271	938-739	191	939-002	191		
660-220	247	938-740	191	939-003	191		
931-361	191	938-741	191	939-004	191		
931-362	191	938-742	191	939-005	191		
931-363	191	938-743	191	939-445	191		
931-364	191	938-745	191	939-446	191		
931-366	191	938-746	191	939-447	191		
931-367	191	938-747	191	939-448	191		
931-368	191	938-748	191	939-449	191		
931-369	191	938-749	191	939-450	191		
931-371	191	938-750	191	939-451	191		
931-372	191	938-751	191	939-452	191		

MK WORLDWIDE

Head Offices

mk **Austria | Germany**
MK Illumination Handels GmbH
Trientlgasse 70
6020 Innsbruck, Austria
+43 512 20 24 30
info@mk-illumination.com

mk **Denmark**
MK Themed Attractions ApS.
Fluebæksvej 190, 4100 Ringsted
+45 57 67 34 88
rene@mk-illumination.dk

Subsidiaries

mk **BA | HR | KSV | MK | MNE | RS | SI**
MK Illumination d.o.o
Jadranska cesta 25
2000 Maribor, Slovenia
+386 2 620 3543
d.zalokar@mk-illumination.com

mk **Estonia | Latvia | Lithuania**
MK Illumination Baltic AS
Kanali tee 4
10112 Tallinn, Estonia
+372 602 4477
olga@mk-illumination.com

mk **Belgium**
MK Phixion bvba
Ketelaarstraat 9
2340 Beerse
+32 14 618181
philip.vdl@phixion.be

mk **Canada East**
MK Illumination Canada East Inc.
484, Jean Neveu, Longueuil, Qc
Canada, J4G 1N8
+1 450 646 8111
j.guenette@mk-illumination.ca

mk **Canada West**
MK Illumination Inc.
Unit 114, 19097 26th Avenue
Surrey, British Columbia
V3Z 3V7 Canada
+1 604 230 1460
a.urquhart@mk-illumination.ca

mk **China (Sales & Design)**
MK Illumination Design Co., Ltd.
Room 128, Block 1
No. 694 Qu Xi Road, Huangpu
District 200023 Shanghai, China
+86 21 60752400
t.eisner@mk-illumination.com

mk **Czech Republic**
Barcana s.r.o.
Průmyslový areál Vysočany č.p. 67
348 02 Bor
+421 51 7495780
a.kozubik@barcana.cz

mk **Denmark**
MK Illumination ApS.
Fluebæksvej 190
4100 Ringsted
+45 57 67 34 88
rene@mk-illumination.dk

mk **Finland**
MK Illumination OY
Itämerenkatu 5
Helsinki, 00180, Finland
+358 44 244 7706
t.juurikkala@mk-illumination.com

mk **France**
MK Illumination SAS
5 Avenue de la Fontanisse
30660 Gallargues le Montueux
+33 (0)4 66 51 05 85
v.dalmont@mk-illumination.fr

mk **Germany**
MK Light Festival & Event GmbH
Zum Driegeltrath 46
40885 Ratingen
+49 170 917 95 29
k.koenig@mk-illumination.com

mk **Hong Kong**
MK Illumination Hong Kong Ltd.
Wilson House, Suite 1303
19-27 Wyndham Street
Hong Kong
+86 755 8230 5830
t.eisner@mk-illumination.com

mk **Hungary**
MK Hungaria Kft.
Baracsi u. 77.
9423 Ágfalva
+36 99 524 007
v.galos@mk-illumination.hu

mk **Ireland | Northern Ireland**
MK Illumination Ireland LTD
Aherla More
Aherla, Cork, Ireland
P31 WK72
john@mk-illumination.ie

mk **Italy**
MK Illumination Italia s.r.l.
Via Ponte Coasso
10073 Cirié (Torino)
+39 (0)11 921 26 05
guido@mk-illumination.it

mk **Japan**
MK Illumination Japan
20-1 Minami Akasaka Kainan City
642-0017 Wakayama, Japan
+81 73 484 3618 / +81 73 484 3619
r.furusawa@takasho.co.jp

mk **Korea**
MK Illumination Korea Ltd.
MK Gangnam Building
Seocho-dong, Seocho-gu, Seoul, Korea
+82 2 536-5926
info@mk-illumination.kr

mk **Mexico**
MK Illumination Mexico
Real de San Martín 29
Col. Santa Bárbara, Azcapotzalco
México D.F.
+52 55 1742 2534
mexico@mk-illumination.la

mk **Netherlands**
MK Illumination Holland
L.J. Costerstraat 15
8141 GN Heino
+31 (0)572 760008
info@mk-illumination.nl

mk **Norway**
MK Illumination AS
Grenseveien 91
0663 Oslo
+47 48090270
o.saetre@mk-illumination.no

mk **Philippines**
MK Themed Attractions Philippines Inc.
Lot 20, Livelihood St. Pampanga
Economic Zone
Angeles City, Pampanga, Philippines
+63 966 940 7173
mfe@mkthemedattractions.com

mk **Poland**
MK Illumination Polska Sp. z o.o.
Łobzów 294A
32-340 Wolbrom
+48 518 675 041
m.seweryniak@mk-illumination.pl

mk **Portugal | Spain**
MK Illumination Unipessoal Lda
Rua da Alegria, n.º 785 - 1.º, Sala 13
4000-047 Porto, Portugal
+351 962 740 324
r.alves@mk-illumination.com

mk **Romania | Bulgaria | Moldavia**
S.C MK Illumination S.R.L
Strada Mihai Viteazu, Bloc Central
Residence, etaj 8, apt.48, Loc. Deva
330015 Jud. Hunedoara, Romania
+40 254 712 714
office@mk-illumination.ro

mk **Russia**
MK Illumination Russia Ltd.
2 Murinskii pr., 34, 1
194021 St. Petersburg
Russian Federation
+7 911 753 52 76
v.savinov@mk-illumination.com

mk **Slovakia**
MK Illumination, s. r. o.
Solivarská 8030/1a
080 01 Prešov
+421 51 7495780
a.kozubik@mk-illumination.sk

mk **South Africa**
MK Illumination South Africa PTY Ltd.
10 Eagle Road, Imbonini Business Park
Shakas Head, 4420 Ballito
+27 83 2560860
lee@mk-illumination.co.za

mk **Sweden**
MK Illumination AB
Box 9010
200 39 Malmö
+46 40 630 04 00
n.johansson@mk-illumination.se

mk **Switzerland**
MK Illumination AG
Widenholzstrasse 1
8304 Wallisellen
+41 (0)44 818 74 00
i.inci@mk-illumination.ch

mk **Turkey | Kazakhstan | Greece**
MK Aydınlatma Pazarlama LTD. STİ
San-Bir Bulvarı 4.
Bölge No:73 Çakmaklı
Büyükcakmece - İstanbul, Turkey
+90 212 886 72 66 / 65
oktay@mk-illumination.com.tr

mk **UAE-GCC**
MK Illumination UAE LLC
Business Bay, Bay Square, Building 7
Office 601-03 P.O Box 32768, Dubai, UAE
+971 4 567 4903
nader@mk-illumination.ae

mk **Ukraine**
MK Illumination UA
Konstantinovskaya 73
04080 Kiev
+380 979895794
am@mk-illumination.com.ua

mk **United Kingdom**
MK Illumination UK Ltd.
Unit 1, Witton Business Park
Preston Old Road
Blackburn, BB2 2TS
+44 (0)1254 778670
sales@mkillumination.co.uk

mk **USA**
American Christmas, LLC
30 Warren Place
Mount Vernon, New York 10550
+1 914 663 0600
dcasterella@americanxmas.com

mk **USA**
MK Illumination, LLC
30 Warren Place
Mount Vernon, New York 10550
+1 914 530 2581
d.casterella@mk-illumination.com

Office

Australia

Visual Inspirations
162 Beechboro Raad
6053 WA South Bayswater
+61 8 9371 8618
ryan@visualinspirations.com.au

Productions



Belgium

MK Phixion bvba
Ketelaarstraat 9
2340 Beerse
+32 14 618181
philip.vdl@phixion.be



Italy

MK Illumination Italia s.r.l.
Via Ponte Coasso
10073 Ciriè (Torino)
+39 (0)11 921 26 05
guido@mk-illumination.it



Russia

MK Illumination Russia Ltd.
2 Murinskii pr., 34, 1
194021 St. Petersburg
Russian Federation
+7 911 921 06 69
a.ignatov@mk-illumination.com



China (PD & QC)

MK Illumination Shenzhen co.,Ltd.
Suite 1310 Gudi Bldg.,
Chunfeng Road, Louho District
518000 Shenzhen
+86 755 82149080
t.eisner@mk-illumination.com



Mexico

MK Illumination Mexico
Real de San Martín 29
Santa Barbara, Azcapotzalco
México D.F.
+52 55 1742 2534
mexico@mk-illumination.la



Slovakia

MK Illumination Production s.r.o.
Solivarská 1
080 01 Prešov
+421 51 2022101
office@mk-illumination.sk



Czech Republic

Barcana s.r.o.
Průmyslový areál Vysočany č.p. 67
CZ 348 02 Bor
+420 371 430 301
m.plesnik@barcana.eu



Philippines

MK Themed Attractions Philippines Inc.
Lot 19, 21, 23, Livelihood St. Pampanga
Economic Zone
Angeles City, Pampanga, Philippines
+63 966 940 7173
mfe@mkthemedattractions.com



South Africa

MK Illumination South Africa PTY Ltd.
10 Eagle Road, Imbonini Business Park
Shakas Head, 4420 Ballito
+27 83 2560860
lee@mk-illumination.co.za



Hungary Warehouse

MK Hungaria Kft.
Baracsi u. 77.
9423 Ágfalva
+43 699 151 894 45
j.billes@mk-illumination.com



Romania | Bulgaria | Moldavia

S.C MK Illumination S.R.L
Strada Mihai Viteazu, Bloc Central
Residence, etaj 8, apt.48, Loc. Deva
330015 Jud. Hunedoara, Romania
+40 254 712 714
office@mk-illumination.ro



Turkey Production

MK Aydınlatma Pazarlama LTD. STİ
San-Bir Bulvarı 4.
Bölge No:73 Çakmaklı
Büyükkçekmece - İstanbul, Turkey
+90 212 886 72 66 / 65
oktay@mk-illumination.com.tr

Symbolerklärung

- Lampenanzahl
- ohne Leuchtmittel
- Flexibler Montagerahmen
- Lampenzeichnung bei der Bestellung erforderlich
- Motive ab 5 cm Tiefe
Motive unter 5 cm Tiefe 2D
- Power Supply
- Batteriebetrieben

Montage Motive

A) Montageart

- P** = Steckmontage
- T** = Hängemontage

B) Befestigungspunkte



Farben

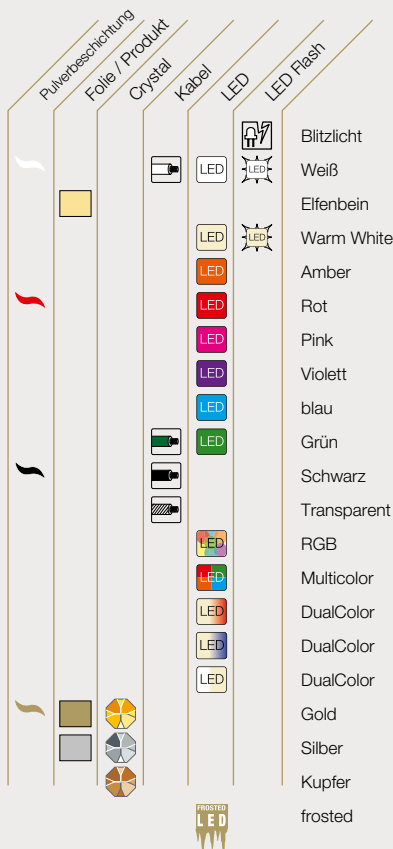

Technische Symbole

- OUTDOOR**
für den Innen- und Außenbereich
- INDOOR**
nur für den Innenbereich
- koppelbar
- BETRIEBSSPANNUNG 230V**
direkter Anschluss ohne Transformator
- BETRIEBSSPANNUNG 36V**
Trafo erforderlich
- SCHUTZART IP44**
spritzwassergeschützt
- SCHUTZART IP54**
staub- & spritzwassergeschützt
- SCHUTZART IP67**
staub- & wassergeschützt
- SCHUTZKLASSE 1**
Schutzerdung
- SCHUTZKLASSE 2**
doppelt isolierte Kabel
- SCHUTZKLASSE 3**
SELV
- QuickFix™ SYSTEM Low Voltage+**
QuickFix™ Niedervoltssystem
- QuickFix™ SYSTEM Outdoor+**
für den Innen- und Außenbereich
- QuickFix™ System indoor**
nur für den Innenbereich
- QuickFix™ 3+ System**
für den Innen- und Außenbereich mit Schutzleiter
- A) VPE Produktverpackung
B) VPE Transportverpackung
- schwer entflammbar
- QuickFix™ Units**
QuickFix™ Längeneinheiten des jeweiligen Produktes
- QuickFix™ Capacity – Verbraucher**
QuickFix™ Energieverbrauch des jeweiligen Produktes
- QuickFix™ Capacity – Leistungsgeber**
Zur Verfügung gestellte QuickFix™ Energie des jeweiligen Leistungsgebers

Editor, Layout and Design: MK Illumination Handels GmbH

Photos: Shutterstock, Fotolia, Pexels, Pixabay, Markus Pienz, Dirk Belitz, Danijel Jovanovic, Peter Wieler, Luminar, Michel Wiegandt, Roland DeFrancesco, Marian Ouatu, Rene Riisalu, Kaspars Garda, Andrew Goldstein, Pierre Kellenberger, SteenOlsson, Raul Pilato, Véronique d'Almont, Kitayama Camera Studio, Angelica Chema Sierra, Stefan Kemper, Anna Sherbakova, Mikael Sjöberg, Morten Sobys, Andi Morrison, Nicolaas Sillem, Greg Fonne, Christina Decker, Dirk Aigner, Johannes Reykdal, Viktor Gálos, Mario Kamps, Massimiliano Goglio, Malin Ahlberg, Camilla Rosén, Olivia Janschek, Oktay Süreka, Till Herrmann, Andreas Kampl, Anna Merkurlova, Nicholas Carrol, Andrew Beasley Photography, Imre Krenn, Ramberg fotografen, Brett Gundlock/ Boreal Collective, Caroline Field, Aldrick Carl C. Reyes, Marcel Kusch, Lindsay Lauckner, Wojciech Wandzel, Beatrice Busco, BelleTronche par Bonnallie Brodeur, Idris Ekinci

Text: Suzanne Whitby, Bernadette Larcher

Print: Gutenberg-Werbering Gesellschaft m.b.H.

All rights reserved. Errors and omissions excepted. Product information is subject to change.

© 2019 by MK Illumination



Enlightening your vision. | www.mk-illumination.com